

Please read this manual carefully before installation and keep it for future reference.

# Owner's Manual



**MRCOOL®**

**COMFORT MADE SIMPLE**

Universal® Series  
Air Handler | 4-5 Ton  
Model - MDUI18048/MDUI18060

Thank you for choosing MRCOOL. Please read this manual carefully before installation and keep it for future reference.

## **!** Safety Precautions ..... 2

## **1** Appliance Overview ..... 5

- 1. Introduction ..... 5
- 2. Accessories ..... 6
- 3. Unit Dimensions ..... 7
- 4. Main Parts ..... 8

## **2** Unit Installation ..... 9

- 1. Pre-Installation Instructions..... 9
- 2. Installation Location ..... 10
- 3. Conventional Line Set Installation..... 11
- 3. No-Vac® Quick Connect ® Installation..... 12
- 4. Condensate Removal ..... 13
- 5. Ductwork ..... 14
- 6. Electric Heater ..... 14
- 7. Air Handler Field Conversion ..... 16
- 8. Electrical Connection ..... 17

## **3** Post Installation Checks ..... 23

## **4** Troubleshooting ..... 25

## **5** Maintenance and Care .....29

## **6** EU Disposal Guidelines ..... 30

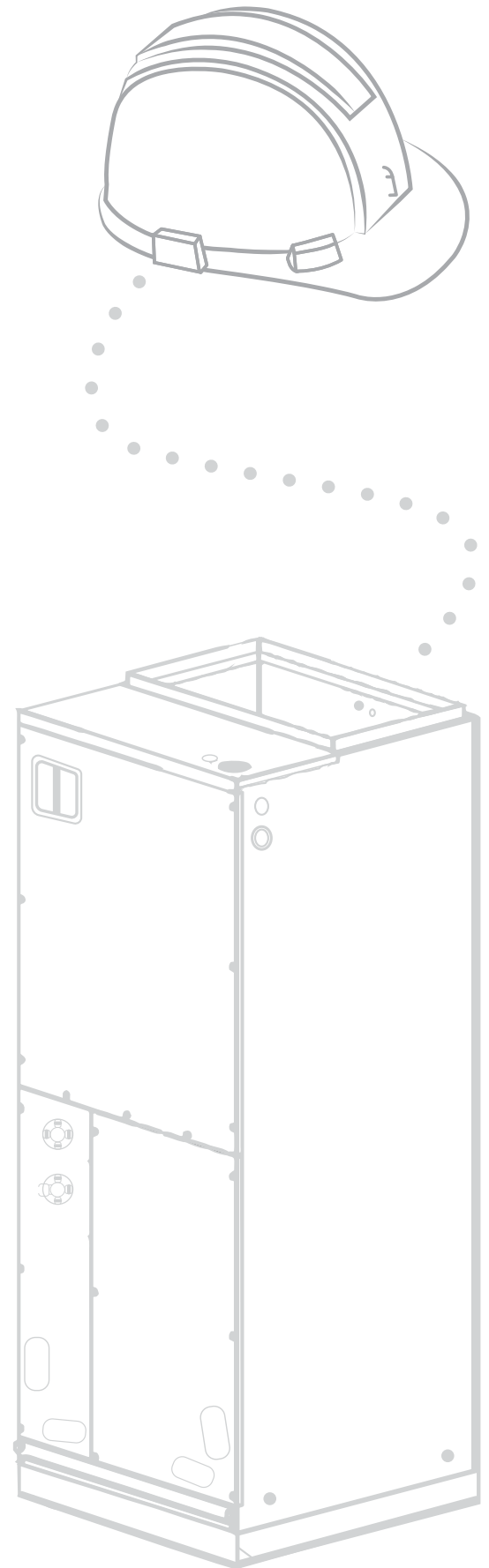

# Safety Precautions



## Read Before Installation

**Incorrect installation may cause serious damage or injury.**

The seriousness of potential damage or injuries is classified as either a **WARNING** or **CAUTION**.



**WARNING**

This symbol indicates ignoring instructions may cause death or serious injury.



**CAUTION**

This symbol indicates that ignoring instructions may cause moderate injury to your person, damage to your unit, or other property.



This symbol indicates that you should **NEVER** perform the indicated action.



## **WARNING**

***Please read the manual in its entirety before installing, operating or repairing.***

- ⊘ **DO NOT** share the electrical circuit with other appliances. Improper or insufficient power supply can cause fire or electrical shock.
  - ⊘ When connecting refrigerant piping, **DO NOT** let substances or gases other than the refrigerant enter the unit. The presence of other gases or substances will lower the unit's capacity, and may cause abnormally high pressure in the operation cycle. This may cause explosion and injury.
  - ⊘ **DO NOT** connect the ground wire to a gas pipe, water pipe, lightning arrester or telephone wire.
  - ⊘ **DO NOT** allow children to play with the air conditioner. Children should be supervised around the unit at all times.
  - ⊘ **DO NOT** alter the settings of the pressure sensor or other protective devices; if short-circuited or modified, fire or even an explosion could occur.
1. Installation must be performed by an authorized technician. Improper installation may cause water leakage, electrical shock, or fire.
  2. Installation must be performed according to installation instructions. Improper installation may cause water leakage, electrical shock, or fire.
  3. In North America, installation must be performed in accordance with the requirement of NEC and CEC (by authorized personnel only.) Contact an authorized service technician for repair or maintenance of the unit.
  4. Only use the included accessories and specified parts for installation. Using non-standard parts can cause water leakage, electrical shock, or fire and may cause the unit to fail.

## **WARNING**

5. Install the unit in a firm location that can support the unit's weight. If the installation location cannot support the weight, or the installation is performed improperly, the unit may fall and cause serious injury and/or damage.
6. For all electrical work, follow all appropriate wiring standards, regulations, and the Installation Manual.
7. You must use an independent circuit to supply power. Do not connect other appliances to the same circuit. Insufficient electrical capacity or defects in electrical work can cause electrical shock or fire.
8. For all electrical work, fuse the specified cables. Connect cables tightly and clamp them securely to prevent external forces from damaging the terminal. Improper electrical connections may overheat, causing fire and/or electrical shock.
9. All wiring must be properly arranged to ensure that the control board cover can close properly. If the control board cover is not closed properly, it can lead to corrosion and cause the connection points on the terminal to overheat, causing fire and/or electrical shock.
10. In certain functional environments, such as kitchens, server rooms, etc., the use of specially designed air-conditioning units is highly recommended. If the supply cord is damaged, it must be replaced by the manufacturer, its service agent, or similarly qualified persons in order to avoid a hazard.
11. This appliance can be used by children aged 8 years and older and persons with reduced physical, sensory, or mental capabilities or lack of experience and knowledge if they have been given supervision or instruction concerning use of the appliance in a safe way and understand the hazards involved. Children should not play with the appliance. Cleaning and user maintenance should not be made by children without supervision.
12. The air conditioner unit can only be cleaned after it has been turned off and disconnected from power, otherwise electric shock may occur.
13. If installed in a compact space, ensure that there is adequate ventilation in case of leakage. Concentration of refrigerant gas can lead to explosion and other hazards.
14. The fixed wires connecting to this appliance must be configured with an all-pole disconnect under voltage class III.

### **Note about Flourinated Gases:**

1. This air-conditioning unit contains R410A flourinated gases.
2. The refrigerant gas may not have an odor, thus this should not be considered a means of leak detection.
3. Installation, service, maintenance, and repair of this unit must be performed by a certified technician.
4. Product uninstallation and recycling must be performed by a certified technician.
5. If the system has a leak-detection system installed, it should be checked for leaks at least every 12 months.
6. Keep a record of all leak checks for the lifetime of the unit.

## CAUTION

- ⊘ For units that have an auxiliary electric heater, **DO NOT** install the unit within 3 feet (1 meter) of combustible materials.
  - ⊘ **DO NOT** install the unit in a location that may be exposed to combustible gases. If combustible gas accumulates around the unit, it may cause fire.
  - ⊘ **DO NOT** operate your air conditioner in a wet room such as a bathroom or laundry room. Too much exposure to water may cause electrical components to short circuit.
  - ⊘ **DO NOT** put appendages or other objects into the air inlet or return grills.
  - ⊘ **DO NOT** stop the appliance by directly cutting off the power. Turn off the unit first.
  - ⊘ **DO NOT** install the appliance in areas with:
    - oil, smoke, or volatile liquid; as plastic parts may deteriorate, adversely affecting the integrity and functionality of the appliance.
    - corrosive gas; as this may corrode copper piping and welds, adversely affecting the integrity and functionality of the appliance.
  - ⊘ **DO NOT** force-dry the filter using open flame or blowers, as this could damage it.
1. This appliance must be properly grounded during installation, or electrical shock may occur.
  2. Install drainage piping according to the instructions in this manual. Improper drainage may cause water damage to your home and property.
  3. This appliance must be stored in a well ventilated area equal in size to the area specified for operation.
  4. Use proper measures to protect the unit from rodents and other small animals that may damage electrical components, causing the unit to malfunction.
  5. If wired control (i.e. a wall-mount thermostat) is to be used, it should be connected first before powering up the unit, otherwise it may not function properly.
  6. Only use a soft dry cloth or, as necessary, a slightly wet cloth with neutral detergent to clean the casing of this appliance.
  7. Before operating the unit under low temperature, connect it to power for 8 hours. If it is deactivated for a short time, for example, one night, do not cut off the power (this is to protect the compressor).

To Our Customers;

Thank you for choosing a MRCOOL home HVAC product. Please read this manual carefully before installation and operation of the Universal® Series Air Handler to ensure correct use and handling. In addition to the safety precautions in the previous section, please adhere to the following guidelines and note our exceptions to liability.

1. This appliance can be used by children aged 8 years and older and persons with reduced physical, sensory or mental capabilities or lack of experience and knowledge if they have been given supervision or instruction concerning use of the appliance in a safe way and understand the hazards involved. Children should not play with the appliance. Cleaning and user maintenance should not be made by children without supervision.
2. To ensure product reliability, the unit may consume power under stand-by status to maintain normal communication, and for preheating refrigerant and lubricant. If the unit will not be used for an extended period, disconnect the power supply. Reconnect the power supply and preheat the unit prior to use.
3. Ensure you have selected the proper model for the operating environment. Improper selection may impact operating performance.
4. This product has undergone strict inspection and operational testing before leaving the factory. To avoid damage due to improper disassembly, which may impact the normal operation, please do not disassemble the unit without proper training and equipment.
5. For technical assistance, please contact MRCOOL technical support at (270) 366-0457.
6. If the product is malfunctioning and/or is inoperable, please contact MRCOOL technical support at the aforementioned number, as soon as possible and provide the following information:
  - a. Product Nameplate Contents (model number, cooling / heating capacity, product serial number, factory date)
  - b. Nature of Malfunction (specify the circumstances before and after the error occurred)
7. All illustrations and information in the instruction manual are for reference only. In order to improve the product, we will continuously assess and innovate. We retain the right to make necessary revisions to the product from time to time. We reserve the right to revise the contents of this manual without notice.
8. If the supply cord is damaged, it must be replaced by MRCOOL, a professional service agent or similarly qualified person in order to avoid damage to the product.
9. MRCOOL, LLC assumes no responsibility for personal injury, property loss or equipment damage caused by improper installation and commissioning, unnecessary maintenance, or failure to follow relevant federal and state regulations, industrial standards, and the requirements of this instruction manual.
10. MRCOOL, LLC will bear no responsibilities for personal injury or property damage caused by the following:
  - a. Improper use of the appliance
  - b. Altering, maintaining, or operating the product with non-approved equipment.
  - c. Altering, maintaining, or operating the product outside of the guidelines of this manual.
  - d. Defects caused by corrosive gas.
  - e. Defects caused by shipping damage.
  - f. Failure to abide by this instruction manual or government regulations.
  - g. Products made by other manufacturers
  - h. Natural disasters, improper installation environment, or force majeure.

# Appliance Overview

The Universal® Series Air Handler offers the perfect combination of superior product quality, operating efficiency, operating sound levels, and value for money. The condensing unit uses the environmentally friendly refrigerant R410A, which is chlorine-free to help prevent damage to the ozone layer.

Unless otherwise stated (as "OPTIONAL") the air conditioning system includes the following accessories. Use all of the installation parts and accessories to install the air conditioner. Improper installation may result in water leakage, electrical shock, fire, or equipment failure.

## Accessories

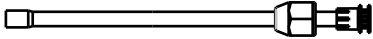
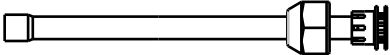
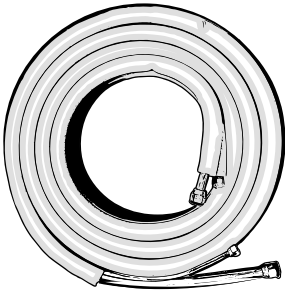
PART	LOOKS LIKE...	QUANTITY
<b>Owner's Manual</b>		<p>1 (this)</p>
<b>Liquid Side Stub Kit (Optional - Sold Separately)</b>		<p>1 To connect the unit with the liquid pipe</p>
<b>Gas Side Stub Kit (Optional - Sold Separately)</b>		<p>1 To connect the unit with the gas pipe</p>
<b>OPTIONAL No-Vac® Quick Connect® Lineset Gas / Liquid Pipe Assembly</b>		<p>1</p>

## Unit Dimensions

MDUI18048/MDUI18060

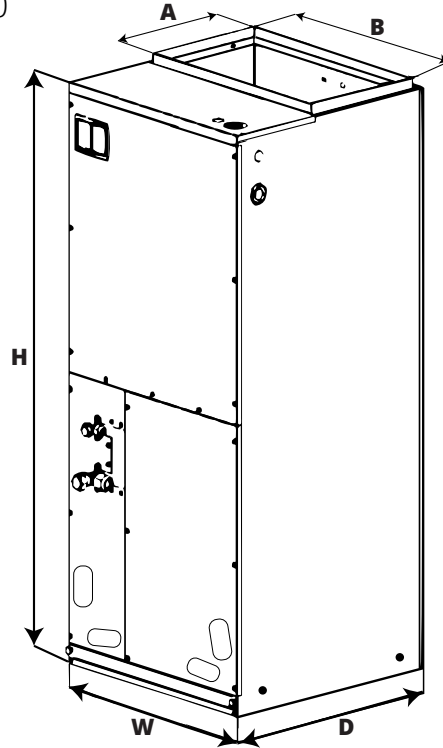

Fig. 1.1

### Unit Dimensions (Inches/MM)

Width	Depth	Height	A	B
24-3/4 in. (630mm)	21-1/4in. (540mm)	57in. (1448mm)	11-5/8in. (295mm)	20in. (508mm)



## Main Parts

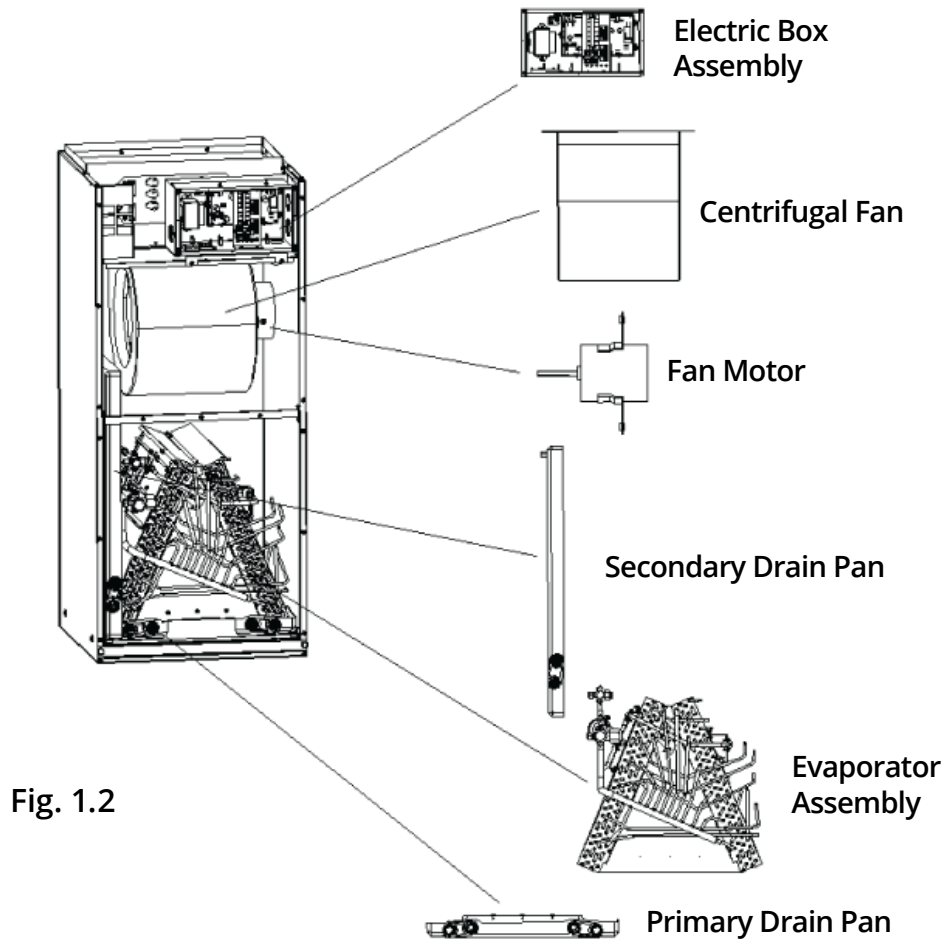

Model	Cooling capacity(ton)	Optional electric heater (kW)
MDUI18048	4.0	15
MDUI18060	5.0	15

Model	Motor @ 230V ~, 60Hz	
	HP	FLA
MDUI18048 / MDUI18060	3/4	3.2

Unit: inch( mm)

Model	Filter size
MDUI18048 / MDUI18060	20-11/16×20-5/16×5/8 (525×516×15)

### NOTE

1. Dry coil and filter should be installed based upon nominal tonnage.
2. Use 0.96 as approximate SCFM correction factor for wet coil (optional).

## **! The Universal® Series has 2 installation methods**

### **1. The Conventional Weld Line Set Installation**

Instructions can be found on **page 11**  
OR  
View complete install video by scanning this QR code



### **2. No-Vac® Quick Connect® Line Set Installation**

Instructions can be found on **page 12**  
OR  
View complete install video by scanning this QR code



**MRCOOL®**  
Preferred Method

## **! CAUTION**

- Before serving or installing this equipment, the electrical power to this unit must be in the “off” position.
- More than one electrical disconnect may exist on this unit. Failure to observe this warning may result in electrical shock that can cause personal injury or death.
- Due to high system pressure and electrical shock potential, installation and service work can be dangerous. Only trained and qualified persons are permitted to install or service this equipment. Observe all warnings contained in this manual and labels/tags attached to the equipment.

### **1. Checking Product Received**

After receiving the product, please check for any damage caused by transportation. Shipping damage is the responsibility of the carrier. Verify the model number, specifications, and accessories are correct prior to installation. The distributor or manufacturer will not accept claims from dealers for transportation damage or installation of incorrectly shipped units. If an incorrect unit is supplied, it must not be installed and it is to be returned to the supplier. The manufacturer assumes no responsibility for the installation of incorrectly delivered units.

### **2. Before Installation**

Carefully read all instructions for the installation prior to installing product. Make sure each step or procedure is understood and any special considerations are taken into account before starting installation. Assemble all tools, hardware and supplies needed to complete the installation. Some items may need to be purchased separately. Make sure everything needed to install the product is on hand before starting.

### **3. Codes & Regulations**

This product is designed and manufactured to comply with national codes. It is installer’s responsibilities to install the product in accordance with such codes and/or any prevailing local codes/regulations. The manufacturer assumes no responsibilities for equipment installed in violation of any codes or regulations.

### **4. Replacement Parts... (continued on following page)**

# Unit Installation

## 4. Replacement Parts

When reporting shortages or damages, or ordering repair parts, give the complete product model and serial numbers as stamped on the product. Replacement parts for this product are available through your contractor or local distributor.

## Installation Location



### WARNING

- This air handler is designed for indoor installation only. Do not install it outdoors.
  - When installing the air handler, take consideration to minimize the length of refrigerant tubing as much as possible.
  - When installing in an area directly over a finished ceiling (such as an attic), installation of an emergency drain pan is required directly under the unit. See local and state codes for requirements.
  - When installing this unit in an area that may become wet, elevate the unit with a sturdy, non-porous material. In installations that may lead to physical damage (i.e. a garage), it is advised to install a protective barrier to prevent such damage.
  - ⊘ This air handler is designed for a complete supply and return ductwork system. **DO NOT** operate this product without complete ductwork attached.
  - ⊘ **DO NOT** install the air handler in a location above or below the condenser that violates the instructions provided with the condenser. Service clearance is to take precedence. Allow a minimum of 24" service clearance in front of the unit.
  - ⊘ **DO NOT** install the air handler in enclosed areas, such as garages, utility rooms or parking areas. Carbon monoxide producing devices (such as an automobile, space heater, gas water heater, etc.) should not be operated in enclosed areas such as unventilated garages, utility rooms or parking areas because of the danger of carbon monoxide (CO) poisoning resulting from exhaust emissions. If a furnace or air handler is installed in an enclosed area such as a garage, utility room, or parking area, and a carbon monoxide producing device is operated therein, there must be direct ventilation to the outside. Adequate ventilation is necessary to avoid the danger of CO poisoning which can occur if a carbon monoxide producing device continues to operate in an enclosed area. If these warnings are not followed, Carbon monoxide emission can be (re)circulated throughout the building from the air handler causing serious illness including permanent brain damage or death.
- 
- If air handler is installed as **Fig. 2.1**, the air handler should be concealed in a specific room or space and make sure the air handler is not accessible to the general public.
  - If air handler is installed as **Fig. 2.2**, make sure there is enough space for care and maintenance and the height between the air handler and ground is above 8 feet/2500mm. and the air handler is not accessible to the general public.

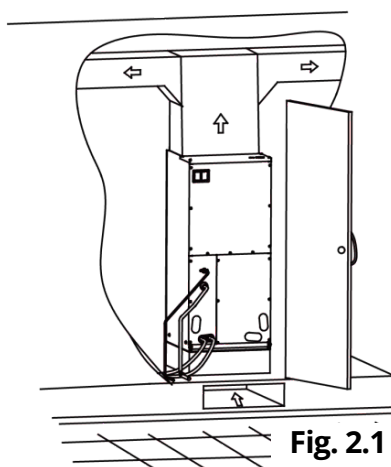

Fig. 2.1

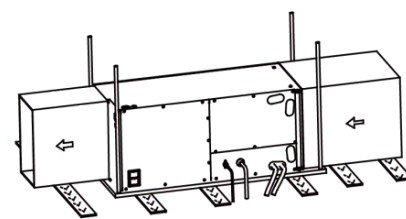

Fig. 2.2

## Conventional Line Set Installation

### Specification of Connection Pipe

Model	External diameter (inch)	
	Vapor pipe	Liquid pipe
MDUI18048 / MDUI18060	3/4	3/8

### Piping Preparation

#### 1. WELD Type Complete Unit Replacement

All cut ends are to be round, burr free, and cleaned. Failure to follow this practice increases the chances for refrigerant leakage. Line set size matches service valve connection. **DO NOT** crimp service valve connector when pipe is smaller than connector. See diagram below.

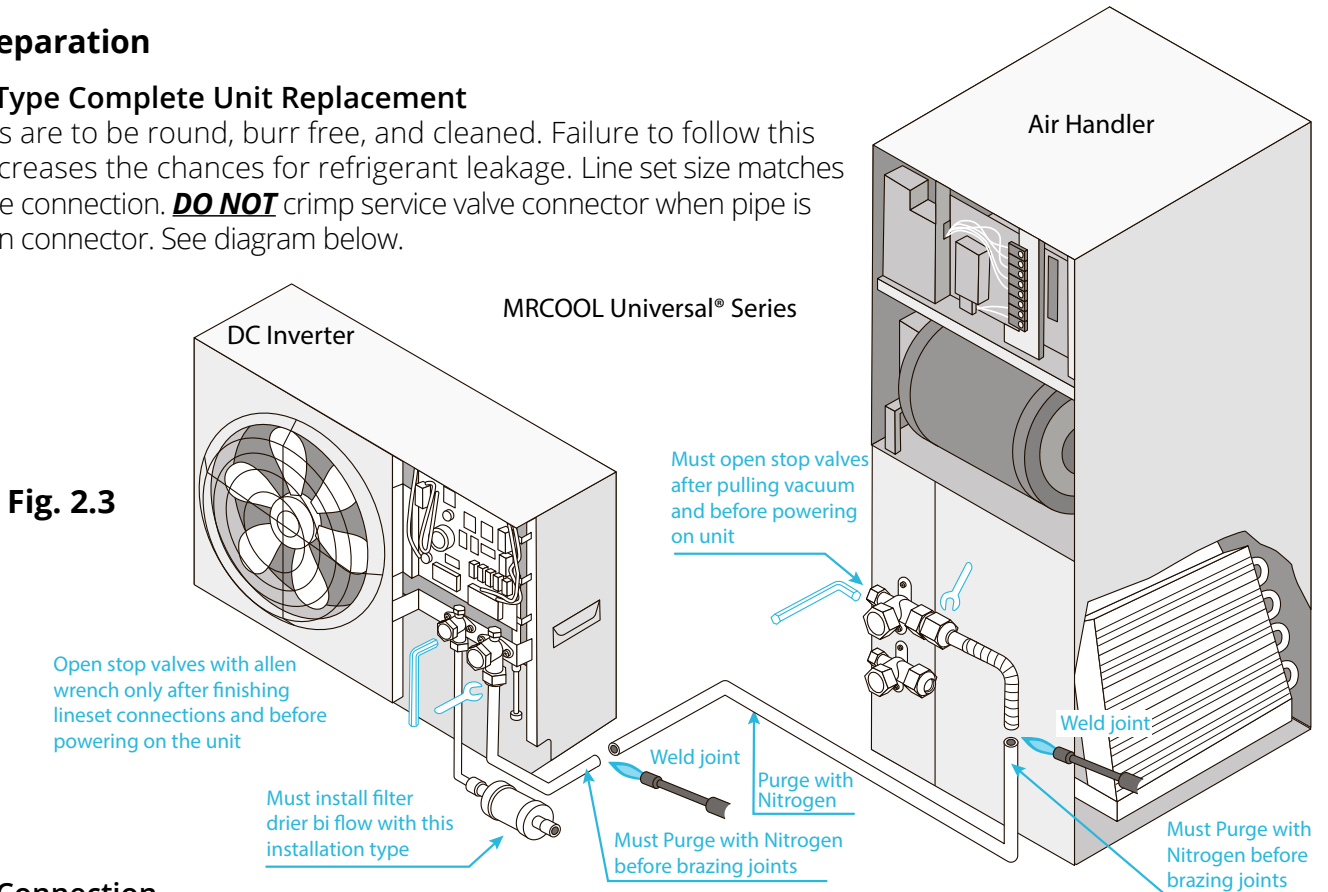

#### 2. Screw Connection

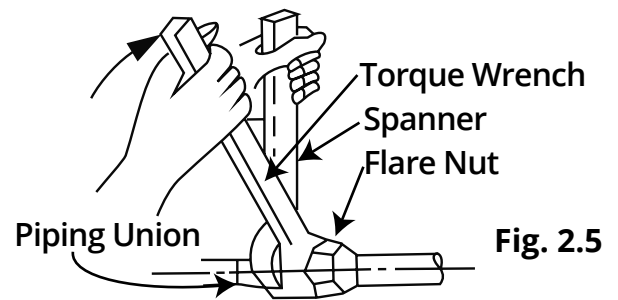
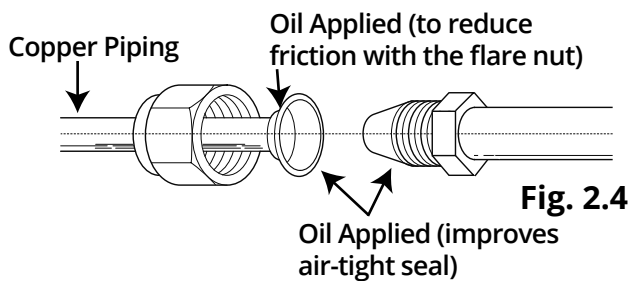

Pipe diameter (inch)	Tightening torque (N·m)
1/4	15-30
3/8	35-40
1/2	45-50
5/8	60-65
3/4	70-75
7/8	80-85

## INSTRUCTIONS FOR USE WITH NO-VAC™ QUICK CONNECT® LINE SET SOLD SEPARATELY KINK RESISTANT, PRECHARGED, SIMPLE SECURE QUICK CONNECT, 100% CONNECTION GUARANTEE

Please read and follow the instructions and diagram below<sup>1</sup> :

Connections must be made exactly as specified to avoid system leaks and /or damage

1. Take out matching male connectors **M1** and **M2**.
2. **Remove** protective cap with the copper gasket at each stop valve on the **DC INVERTER** and ensure the threads are clean and complete.
3. **Tighten** the **M1** connector to the **cutoff valve \*1** with a tightening force of 50N.  
**Tighten** the **M2** connector to the **cutoff valve \*2** with a tightening force of 70N.
4. **Repeat** step 3 for **AIR HANDLER** at the other end of the **LINE SET**.
5. Unroll and route the **LINE SET** between the **AIR HANDLER** and the **DC INVERTER**.
6. **Remove** the protective caps of the valves at both ends of the **LINE SET**. Verify that all threads are clean and complete.
7. **Tighten** the **LINE SET F1** valve to the **M1 Connector** (attached in step 3) with a force of **45N**. **Tighten** the **LINE SET F2** valve to the **M2 Connector** (attached in step 3) with a tightening force of **65N**.
8. **Repeat** this process for the **AIR HANDLER** at the other end of the **LINE SET**.
9. At the **OUTDOOR UNIT** **remove** the **protective cap** at the **cutoff valve switch** and **open** the **cutoff valve** with a hex wrench to run the refrigeration circuit. **If** there is any fizz, grease or other **leakage**, **close** the valve **immediately** and **check** that **steps 3 and 7** were done properly. **Otherwise**, immediately **apply soapy water** for micro-leakage detection. Soak the joints using a sponge or spray bottle. **If any bubbles form**, **close** the valve **immediately** and **check** that **steps 3 and 7** were done properly.
10. **After** the correct connection, **re-tighten** the cutoff valve's **protection cap** and **cover** the M1, M2 and F1, F2 connections with the grey **insulating sleeve** to help **prevent condensation**.

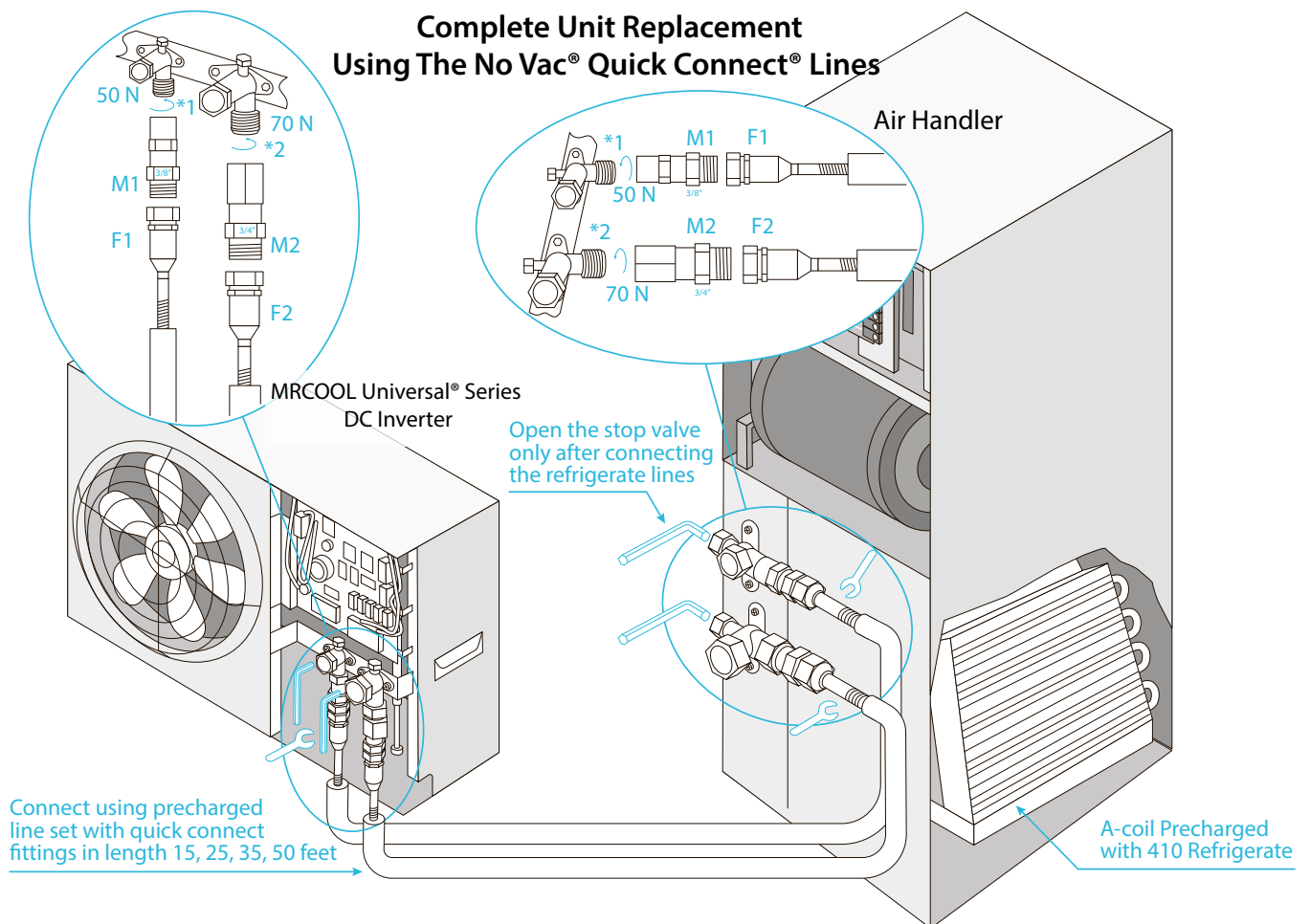

Failure to follow the instructions provided could result in severe harm to you, this product, or other property. The manufacturer, distributor, and seller are not responsible for any harm resulting from the failure to follow instructions and the failure to follow these instructions will void any and all warranties express or implied.

[www.mrcool.com](http://www.mrcool.com)

v01-07-2020



## IMPORTANT

**The cutoff valves on the air handlers must be opened AFTER connecting the lines and BEFORE turning on the unit. Otherwise, operation can cause leakage and/or damage to the unit.**

## Condensate Removal

1. **DO NOT** connect the condensate drain pipe into the waste pipe or other pipelines that are likely to produce corrosive or peculiar smells. This will prevent odors from entering indoors or corrupting the unit.
2. **DO NOT** connect the condensate drain pipe into the rain pipe. This will prevent rain water from pouring in and causing property loss or personal injury.
3. The condensate drain pipe should be connected into a special drain system for the unit.
4. The drain pan has primary and secondary drain connections. Condensate removal is performed by attaching a 3/4" PVC pipe to the evaporator coil pan and terminated in accordance with local or state Plumbing/HVAC codes. The installation must include a "P" style trap that is located closely to the evaporator coil. **DO NOT** over-tighten the drain connection in order to prevent damage to the evaporator drain pan. See the following figure for details of a typical condensate line "P" trap.

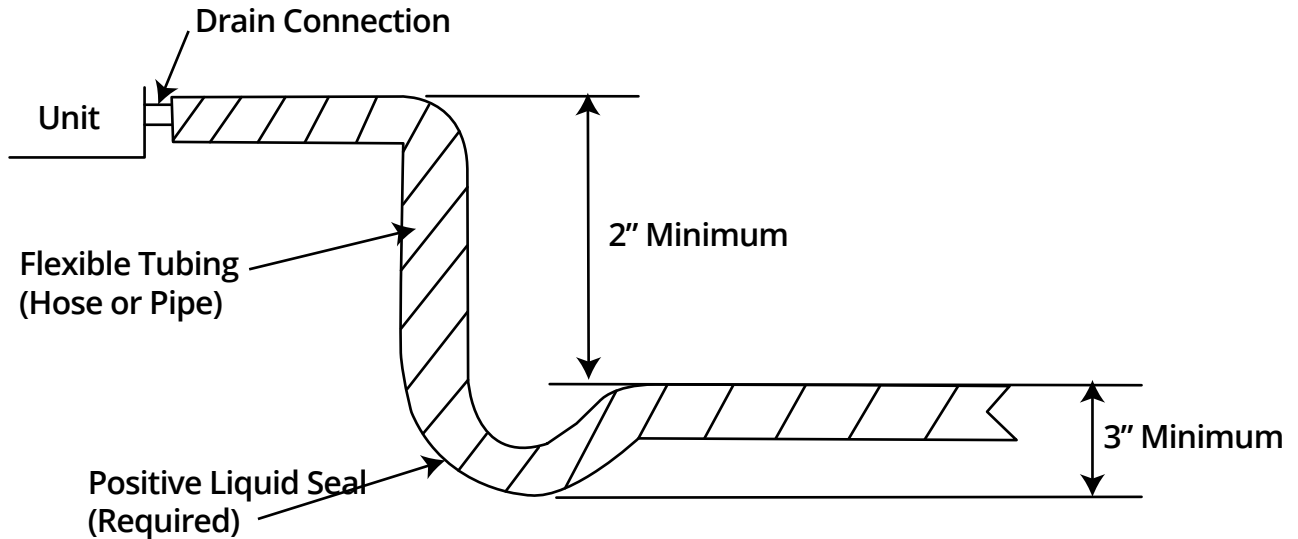

Fig. 2.6

## Ductwork

This air handler is designed for a complete supply and return ductwork system.



### WARNING

**DO NOT** operate the unit without all ductwork completed and attached.

- Inadequate ductwork that restricts airflow can result in improper performance and compressor or heater failure.
- Ductwork is to be constructed in a manner that limits restrictions and maintains suitable air velocity.
- Ductwork is to be sealed to the unit in a manner that will prevent leakage.

### Return ductwork:

Do not install and/or position ductwork in an area that can introduce toxic, or objectionable fumes/odors into the ductwork. The return ductwork is to be introduced into the air handler bottom (upflow configuration).

### Return Air Filters:

Each air handler installation must include a return air filter or external air filter grille.

## Electric Heater

The air handlers listed in this manual do not have a factory installed electric heater. An electric heat kit is available as an accessory. The only heater kits that can be used are **MHK\*\*U** series listed on the following page. Please refer to installation instructions provided with heater kit for the correct installation procedure.



### WARNING

- The electrical characteristics of the air handler, the electric heater kit, and the supply power should be identical.

# Unit Installation

## ! CAUTION

1. Ensure that all power supply is disconnected prior to installing the heater kit.
2. A means of strain relief and conductor protection must be provided at the supply wire entrance into cabinet.
3. Only use copper conductors.
4. Installation must follow national electric code and other applicable codes.
5. If this appliance is installed in an enclosed area such as a garage or utility room with any carbon monoxide producing appliance, ensure the area is properly ventilated to the outside.
6. A filter dryer is recommended for installation based on nominal tonnage.

- 1) Refer to the Table below for the appropriate optional heater kit.
- 2) Check for any physical damage; do not install damaged heater kit.
- 3) Remove the upper access panel from air handler.
- 4) Remove cover plate from air handler.
- 5) Slide the heater kit into the slot and secure element plate with previously removed screws.
- 6) Insert power leads into the circuit breaker lugs or stripped red and black wires (for heater kit without circuit breaker) and tighten.
- 7) Connect ground wire to ground lug.
- 8) Break out appropriate area of the plastic circuit breaker cover on the access panel of the air handler. Knock off the holes according to the actual installation number and circuit breaker positions. If a circuit breaker is not installed, do not knock off the holes; otherwise, electric shock may occur.
- 9) Replace access panel and check operation.
- 10) Connect power cords and thermostat wires.

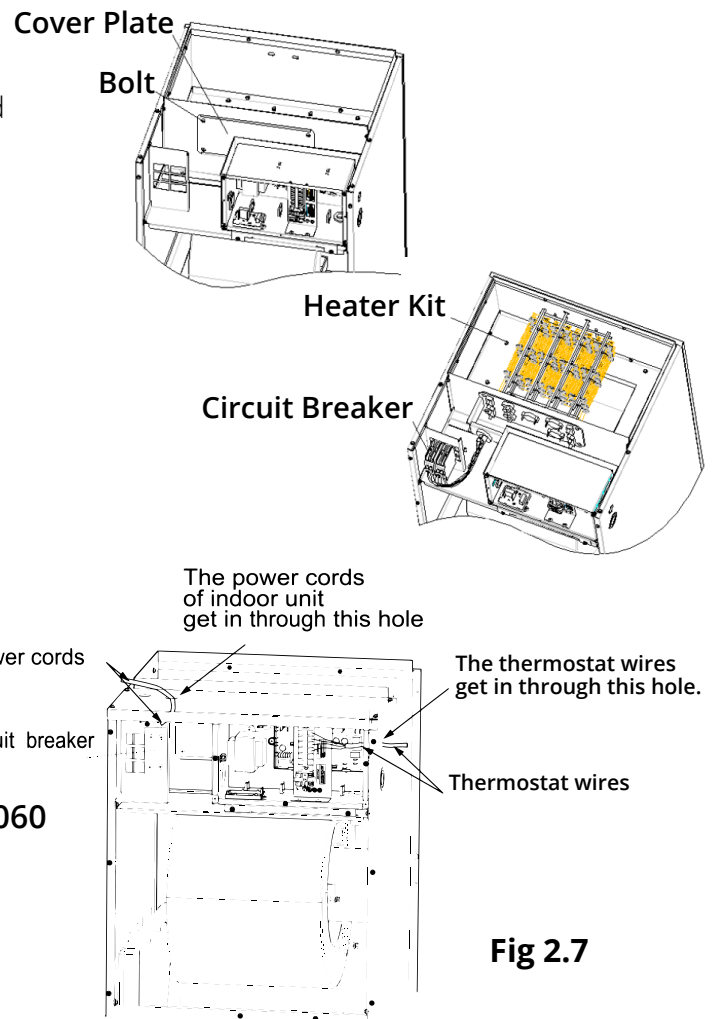

### Compatible Heat Kits for Model# MDUI18048/MDUI18060

Kit #.	Description
MHK15U	Circuit breaker, 15kW heat strip
MHK20U	Circuit breaker, 20kW heat strip

## ! IMPORTANT

**You must use a compatible heat kit listed in the above chart. Using an incorrect size, could cause the unit to overheat and/or cause equipment damage.**



## Air Handler Field Conversion

### Converting Unit From 5 Ton to 4 Ton

Follow these instructions during unit installation in order to enable a Universal® Series 5 ton condenser and air handler split system to operate at 4 ton capacity.

1. **DO NOT** attempt this conversion while the unit is powered on.
2. Locate the capacity dip switch on the air handler main board. The capacity dip switch is circled on the photo below.
3. The default position of the capacity dip switch is 2, 3 & 4 'Up' and 1 'Down' on both the SA2 and SA1 switches.
4. The default position of the capacity dip switch is 60k.
5. To activate the 48k capacity, flip capacity dip switch 1, 3 & 4 on SA2 and SA1 to Down. Flip capacity dip switch 2 on SA2 and SA1 to Up.

Fig. 2.8



DEFAULT 5 TON

Fig. 2.9



4 TON SETTING

Location of Dip Switch on Air Handler Main Board

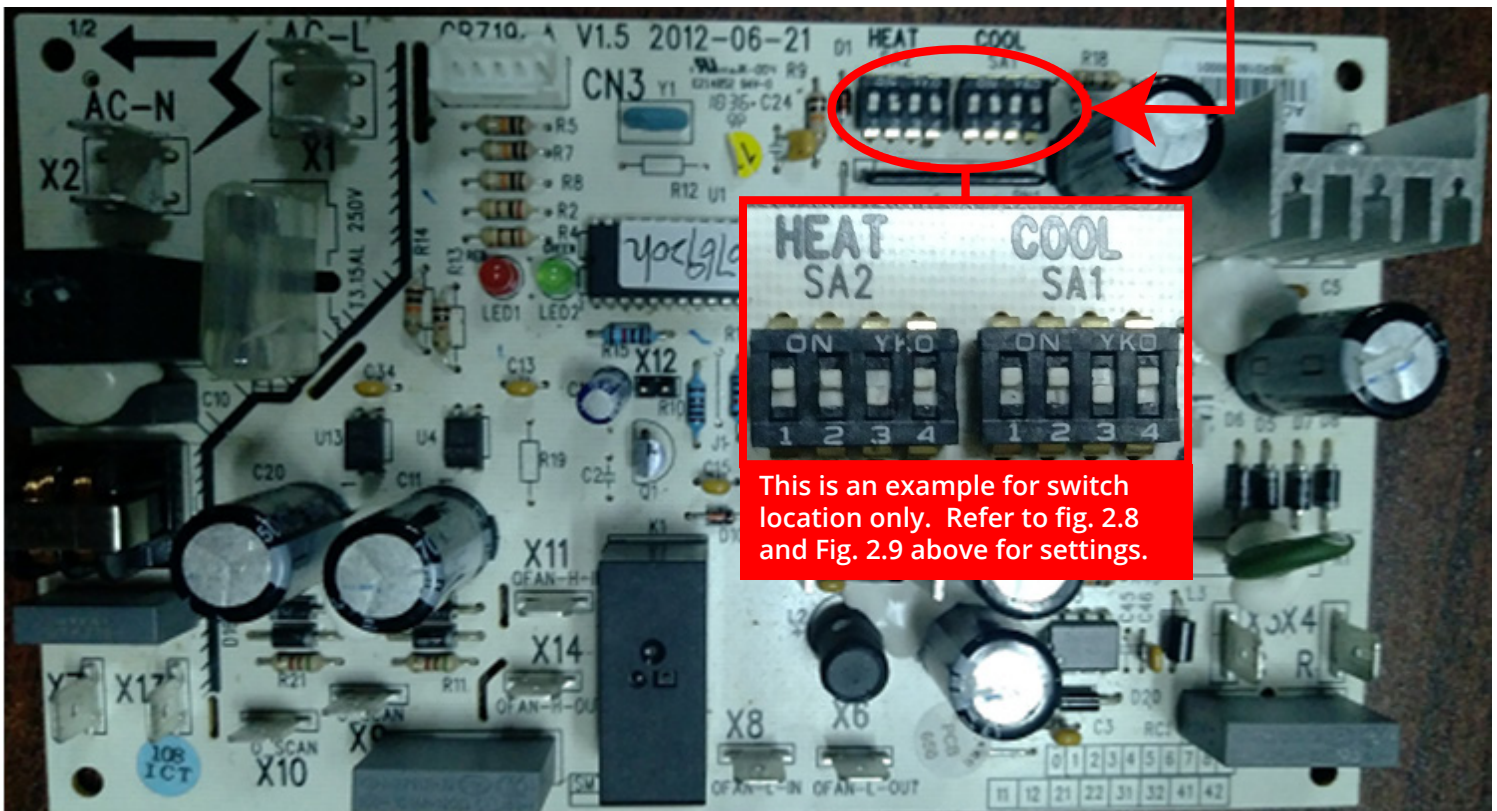

### NOTE

Refer to the Universal® Condenser Manual for the Dip Switch instructions and settings for the condenser.

## Electrical Connection

### Electrical Regulations



#### **WARNING** Before performing electrical work, read the following regulations

1. Electrical installation must be conducted by professionals in compliance with local laws, regulations and this installation manual. Never artificially extend the length of a power cord. The electric circuit must be equipped with a circuit breaker and air switch. Both must have sufficient capacity.
2. Unit operating power must be within the nominal range stated in the instruction manual. Use a specialized power circuit for the unit. Do not draw power from another power circuit.
3. The air conditioner circuit should be at least 1.5m away from any flammable surface.
4. The external power cords, the thermostat wires and thermostat must be effectively fixed.
5. The external power cords, thermostat wires, and thermostat must **NOT** directly contact any hot objects. For example: they must not come into contact with chimney pipes, warm gas pipes or other hot objects.
6. The external power cords, thermostat wires, and thermostat must **NOT** be squeezed. Never pull, stretch or bend the wires.
7. The external power cords, thermostat wires, and thermostat must **NOT** collide with any metal beam or edge on the ceiling, or touch any metal burrs or sharp metal edge.
8. Connect wires in accordance to the circuit diagram labeled on the unit or electric box. Screws must be tightened. Slipped screws must be replaced by specialized flat-head screws.
9. Please use the power cables that are packaged with the appliance. **DO NOT** change the power cables arbitrarily. Do not change the length and terminals of the power cables. If you want to change the power cables, please contact MRCOOL's local service center.
10. Wiring terminals should be connected firmly to the terminal board. Loose connection is not safe.
11. After the electrical installation is finished, please use wire clamps to secure the power cords and thermostat wires. Make sure the wires are not clamped too tight.
12. The wire gauge of the power cord should be sufficiently large. A damaged power cord or other wires must be replaced by specialized wires. Wiring work must be done according to national wiring rules and regulations.

## Electrical Connection

### Electrical Parameters

Outdoor Unit Model	Power Supply	Min. Circuit Ampacity	Max. Overcurrent Protection (A)
MDUI18048/MDUI18060	208/230V 60Hz	4 amps	15 amps

1. The fuse is located on the main board.
2. Install a circuit breaker at every power terminal near the units (indoor unit and thermostat) with at least 0.12in (3mm) contact gap. Both units must reach the plug.
3. Circuit breaker and power cord specifications listed in the above table are determined based on the maximum power input of the units.
4. Specifications of power cords listed in the above table are applicable in a working condition where ambient temperature is 104°F (40°C) and multi-core copper cable (e.g. YJV copper cable, with insulated PE and PVC sheath) is protected by a conduit, and is resistant to 194°F (90°C) in maximum (see IEC 60364-5-52). If working conditions change, please adjust the specifications according to national standards.
5. Specifications of circuit breaker are based on working conditions where the working temperature is 104°F (40°C). If working conditions change, please adjust the specifications according to national standards.
6. Use 5pc of AWG18 power cords as the signal wire between the indoor unit and the thermostat. The maximum length is 98 feet (30m). Please select a proper length according to local conditions. Communication cords must not be twisted together.
7. The gauge of signal wire should not be less than AWG18. It's recommended to use AWG18 power cords as the signal wire.

## Electrical Connection

### Connecting the Power Cord & Thermostat Wire

**For solid wires** (Refer to **Fig. 2.10 A**):

1. Use wire cutters to cut off the wire end and then peel away about 25mm of the insulation layer.
2. Use a screwdriver to unscrew the terminal screw on the terminal board.
3. Use nippers to bend the solid wire into a ring that fits the terminal screw.
4. Form a proper ring and attach to the terminal board. Use a screwdriver to tighten the terminal screw.

**For braided wires** (Refer to **Fig. 2.10 B** & **Fig. 2.10**):

1. Use wire cutters to cut off the wire end and then peel away about 10mm of the insulation layer.
2. Use a screwdriver to unscrew the terminal screw on the terminal board.
3. Use a round terminal fastener or clamp to secure the round terminal firmly on the peeled wire end.
4. Locate the round terminal conduit. Use a screwdriver to replace it and tighten the terminal screw (as shown in **Fig. 2.10**).

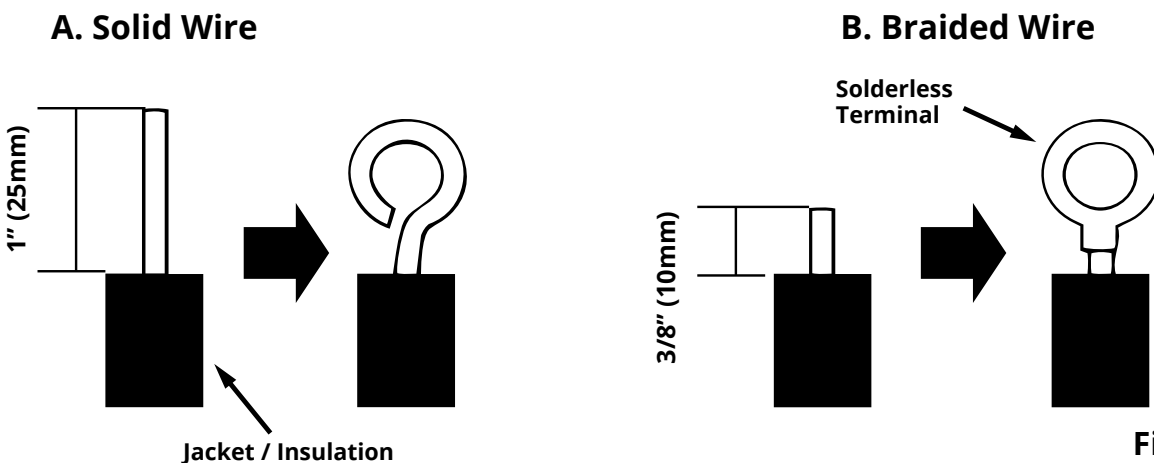

**Fig. 2.10**

## Electrical Connection

### Connecting the Power Cord & Thermostat Wire



#### WARNING

1. Before work begins, please check to ensure the unit and thermostat are powered OFF.
2. Match the terminal numbers and wire colors with the colors indicated in the indoor unit.
3. Wrong wire connection may burn the electrical components.
4. Connect the wires firmly to the wiring box. Incomplete installation may lead to a fire hazard.
5. Please use wire clamps to secure the external covers of connecting wires. (Insulators must be clamped securely; otherwise, electric leakage may occur.)
6. Ground wire should be connected.

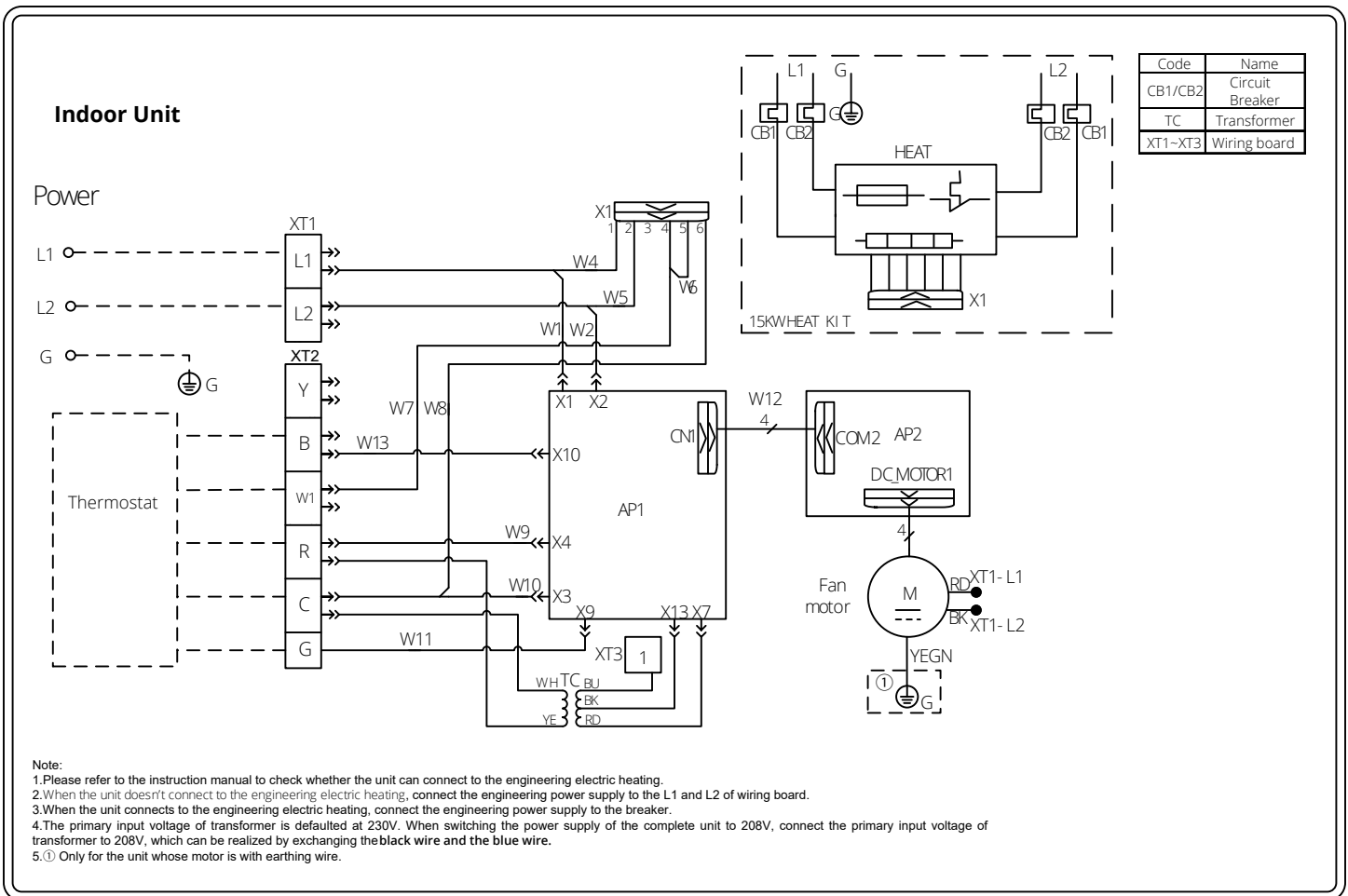

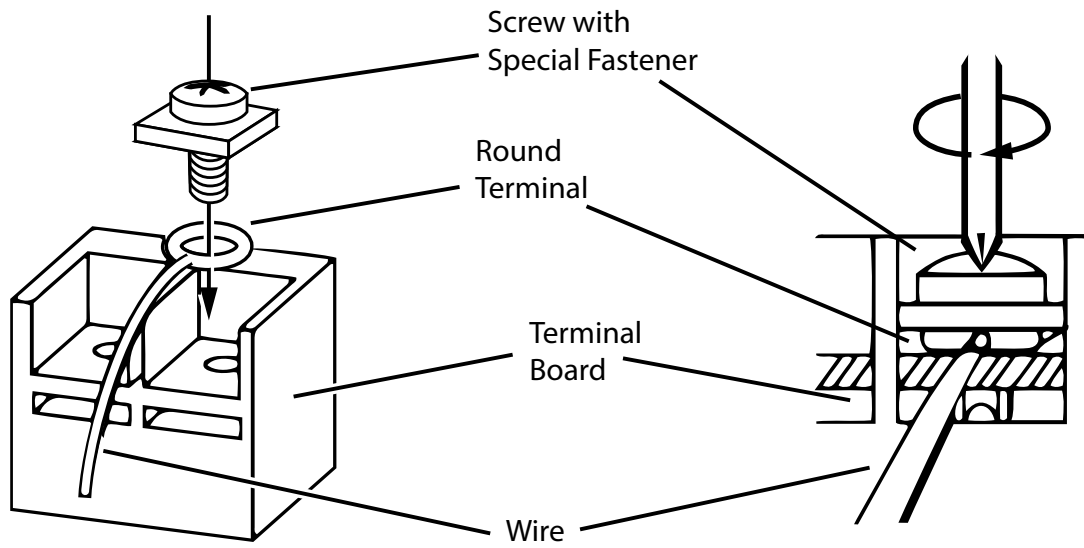

Fig. 2.11

**For all terminal wiring** (Refer to **Fig. 2.13** on the next page):

Lead the thermostat wire and power cords through the insulation tube. Then secure the wires with wire clamps (as shown in **Fig. 2.12**).

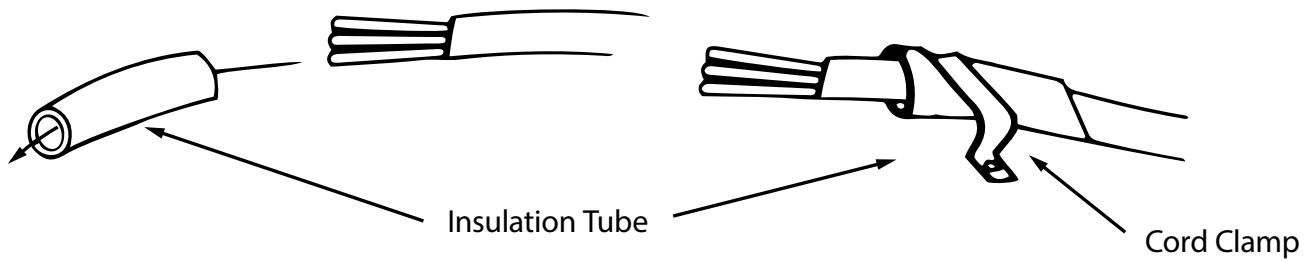

Fig. 2.12

## Electrical Connection

### Connecting the Power Cord & Thermostat Wire



#### WARNING

1. High and low voltage wires should be led through different rubber rings of the electric box cover.
2. Do not bundle the thermostat wires or lay them side by side, otherwise errors will occur.
3. High and low voltage wires should be secured separately. Secure the former ones with large clamps and the latter ones with small clamps.
4. Use screws to tighten the power cords and thermostat wires of the units on the terminal board. Improper connection may create a fire hazard.
5. If the power cords and thermostat wires are not correctly connected, the air conditioner may suffer damage.
6. Ground the units by connecting the ground wire.
7. The units should comply with applicable local and national rules and regulations on power consumption.
8. When connecting the power cord, make sure the phase sequence of the power supply matches with the corresponding terminals, otherwise the compressor will get reversed and operate abnormally.

### Electrical wiring of Single-phase unit: MDUI18048/MDUI18060

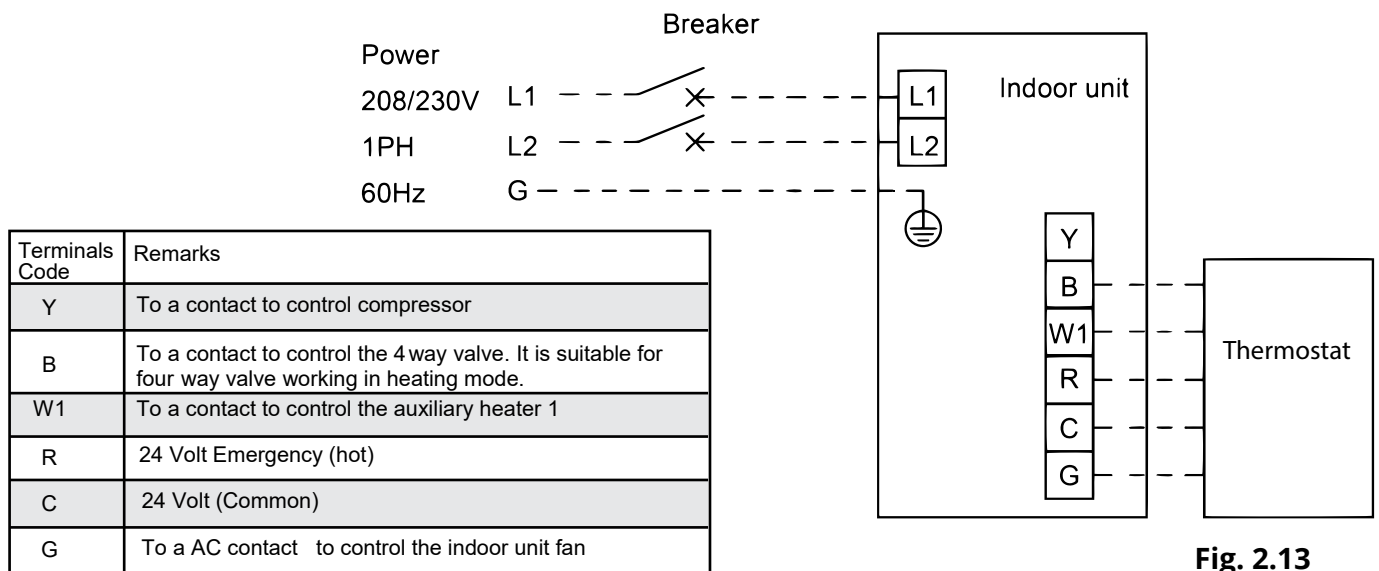

Fig. 2.13

## Before Test Run

Only perform test run after you have completed the following steps:

- **Electrical Safety Checks** – Confirm that the electrical system is safe and operating properly
- **Gas Leak Checks** – Check all flare nut connections and confirm that the system is not leaking
- **Confirm that gas and liquid (high and low pressure) valves are fully open**

List of Checks to Perform	Possible Malfunctions	PASS/FAIL	
Is the main body installed securely?	The unit may fall down, vibrate or produce noise.		
Did you conduct a water leakage test?	Cooling capacity may become unsatisfactory.		
Is the unit well insulated from heat?	Condensate, water drops may occur		
Does water drain properly from drain hose?	Condensate, water drops may occur		
Is the voltage consistent with specifications stated on the nameplate?	The unit may fail or its components may get burned.		
Are the wires, piping, and valves installed correctly?	The unit may fail or its components may ignite.		
Has the unit been safely grounded?	Risk of electric leakage.		
Do the wire specifications wires comply with the requirement?	The unit may fail or its components may ignite.		
Are there any obstacles blocking the air inlet or outlet of the units?	Cooling capacity may become unsatisfactory.		
Have you recorded the length of refrigerant pipe and the refrigerant charging amount?	The refrigerant charging amount can't be controlled.		
Is the panel mounted firmly?	It may cause air leak, vibration, and condensation.		
Are there any cracks in the air return or supply pipe?	It may cause air leak, vibration, and condensation.		



## Test Run

### Preparation Before Connecting The Power:

1. Power must not be connected if the installation is not complete.
2. Verify the control circuit is correct and all the wires are firmly connected. Valves on the vapor and liquid line should be completely open.
3. Remove any scattered objects, especially metal filings and wire clippings.
4. Ensure the unit's appearance and piping system has not been damaged during transportation or handling.
5. Check for any loose terminals and ensure the phases are correct.

### Operation After Connecting The Power:

1. If all the above steps are complete, power on the unit.
2. If there are any loud and/or abnormal sounds, turn off the unit and contact MRCOOL Tech Support immediately.
3. Verify the unit operates normally under several modes.

(1) If your air conditioner fails to function normally, check the following items before conducting maintenance:

Problem	Cause	Corrective Measure
The unit will not activate.	The unit isn't connected to a power supply.	Connect to power supply.
	Low voltage.	Check the circuit voltage is within rated scope.
	Fuse broken or circuit breaker trips off.	Replace fuse or reconnect breaker.
The unit operates but stops immediately.	Air inlet and outlet of the units have been blocked.	Clear any obstacles and keep the area well ventilated.
Abnormal cooling or heating.	Air inlet and outlet of the units have been blocked.	Remove obstacles.
	Inappropriate temperature setting.	Adjust setting at thermostat.
	Doors or windows are opened.	Close the door or windows.
	Direct sunshine.	Draw curtain or louver.
	Too much heat source in the room.	Reduce heat source.
	Filter screen is blocked by dirt.	Clean the filter.



## NOTICE

**Check the above items and take appropriate corrective measures. If the unit continues to function improperly, immediately disconnect power and contact MRCOOL or your installation dealer.**

# Troubleshooting

(2) The following situations are not operation failures.

Problem	Time of Occurrence	Cause
Unit doesn't run.	When unit is started immediately after it is just turned off.	Overload protection switch causes a 3 minute delay.
	When power is turned on.	Start up could be delayed up to 1 minute.
Mist comes from the unit.	During operation.	If the unit is running under high humidity, the wet air in the room will be quickly cooled down.
The unit generates noise.	Slight cracking sound is heard when unit is turned on.	Electronic expansion valve initialization can cause this noise temporarily.
	There is a continuous sound when cooling.	Gas refrigerant flow can cause a slight noise.
	The unit makes a sound when unit starts or stops.	Gas refrigerant flow can cause a slight noise.
	There is slight and continuous sound when unit is running or after running.	The drainage system can cause this noise during operation.
Dust comes from the unit.	When unit runs after no operation for a long period of time.	Dust has settled inside the indoor unit.
The unit emits odor.	During operation.	Smells from the operating environment may be pulled through the air handler.
Indoor unit still runs after switched off.	After every indoor unit receives "stop" signal, fan will keep running.	Indoor fan can be set as "ON" or "AUTO" mode. Under "ON" mode, indoor fan will keep running after switching off the unit.

## Error Code



### WARNING

- 1) **When abnormalities occur, stop the unit immediately and disconnect power. Contact MRCOOL. If the unit continues to run abnormally, it may damage the unit and cause an electric shock or a fire hazard.**
- 2) **DO NOT attempt repairs to the appliance yourself. Improper repair and maintenance can create electric shock and fire hazards. Please contact MRCOOL Tech Support for further guidance or a qualified professional for repairs.**

If the display panel or wired control displays an error code, please refer to the following table:

Number	Error Code	Error
1	E1	Compressor high pressure protection
2	E3	Compressor low pressure protection
3	E4	Compressor air discharge high-temperature protection
4	F2	Condenser temperature sensor error
5	F3	Outdoor ambient temperature sensor error
6	F4	Discharge temperature sensor error
7	F6	Outdoor unit tube temperature sensor error
8	EE	Outdoor unit memory chip error
9	H4	Overload
10	H5	IPM protection
11	H6	DC fan error
12	H7	Driver out-of-step protection
13	HC	Pfc protection
14	Lc	Startup failure
15	P0	Drive reset protection
16	P5	Over-current protection
17	P6	Master control and driver communication error
18	P7	Driver module sensor error
19	P8	Driver module high temperature protection
20	PA	AC current protection
21	Pc	Driver current error

Number	Error Code	Error
22	PL	Bus low-voltage protection
23	PH	Bus high-voltage protection
24	PU	Charge loop error
25	ee	Driver memory chip error
26	e1	High pressure sensor error
27	C4	ODU jumper cap error



## NOTICE

**When the unit is connected with the wired controller, the error code will show simultaneously on it.**

Regular check, maintenance, and care should be performed by professional personnel, which will prolong the life span of the unit.

## Drain Pipe

Regularly check the drain pipe for clogs in order to ensure smooth condensate drainage.

## Notice Before Seasonal Use

1. Check if the inlet/outlet of the indoor unit is clogged.
2. Check if the ground wire is earthed reliably.
3. Check if the filter screen has been set soundly.
4. Check if the unit is installed firmly. If there is something abnormal, please contact the local appointed service center.

## Maintenance After Seasonal Use

1. Cut off main power supply of the unit.
2. Clean filter screen of indoor units.
3. Clean the dust from the indoor units.
4. In the event of rusting, use anti-rust paint to stop the spreading of rust.

## Parts Replacement

Purchase replacement parts from local appointed service center or dealer if necessary.

## After-Sales Service

If the air-conditioning unit you purchased has any quality problem or you have any inquiry, please contact the Mr. Cool Tech Support.

### Warranty should meet the following requirements:

1. First run of the unit should be operated by professional personnel from an authorized service technician.
2. Only factory manufactured accessories can be used on the machine.
3. All the instructions listed in this manual should be followed.
4. Warranty will be automatically voided if the above requirements are not met.

This appliance contains refrigerant and other potentially hazardous materials. When disposing of this appliance, the law requires special collection and treatment. **DO NOT** dispose of this product as household waste or unsorted municipal waste.

When disposing of this appliance, you have the following options:

- Dispose of the appliance at a designated municipal electronic waste collection facility.
- When buying a new appliance, the retailer will receive the old appliance free of charge.
- The manufacturer will receive the old appliance free of charge.
- Sell the appliance to certified scrap metal dealers.

## Special notice

Disposing of this appliance in the forest or other natural surroundings endangers your health and is bad for the environment. Hazardous substances may leak into the ground water and enter the food chain.

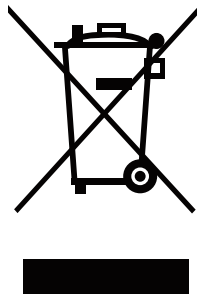



**MRCOOL®**

**COMFORT MADE SIMPLE**

Universal® Series

ELECTRICIAN and/or HVAC TECHNICIAN:

LICENSE #:

INSTALLATION DATE:

INSTALLATION LOCATION:

SERIAL NUMBER: