



PHONE: (941) 751-7596
 FAX: (941) 751-7598
 www.plastecvent.net

Performance & Dimensions

JET 20



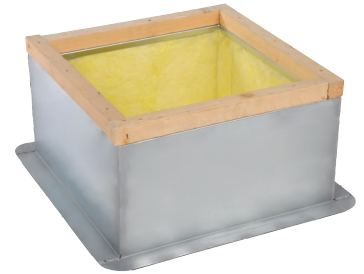

Optional JET Wall Mounting Bracket Available

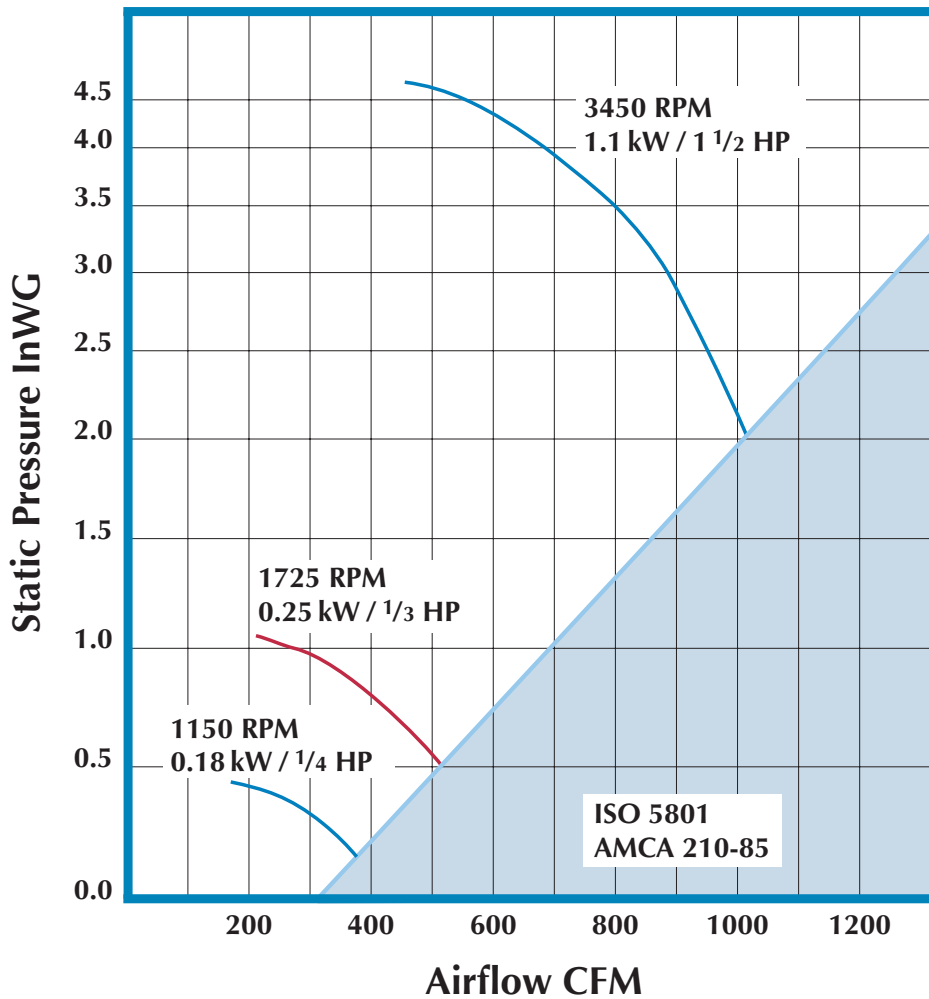

Optional Insulated Galvalume Roof Curb For Flat Roof

Optional 304 Stainless Steel Impeller Available





 Sound Level
 Type A
 Free Inlet/Free Outlet
 Measured at 5 Feet

R.P.M.	LWA dB (A)
1150	64
1725	75
3450	93

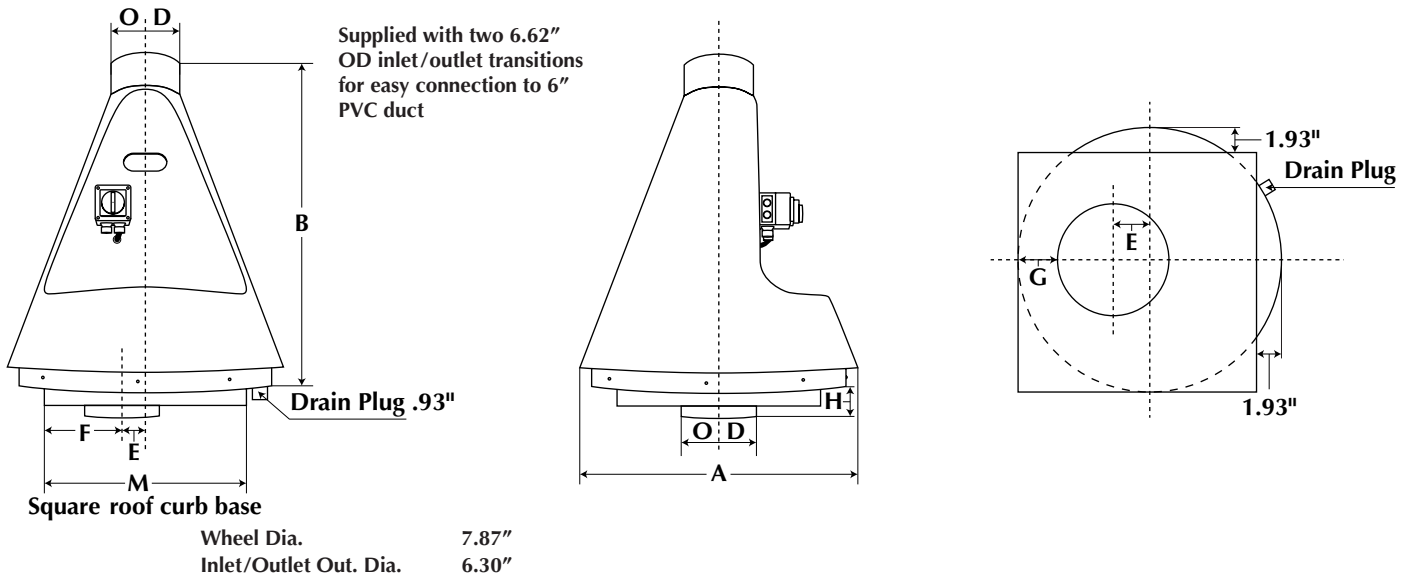
Dimensional Data

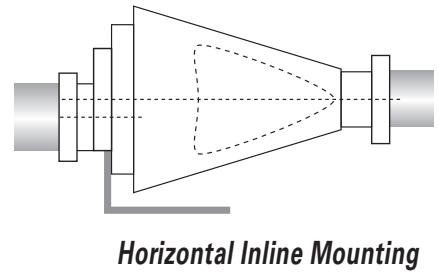
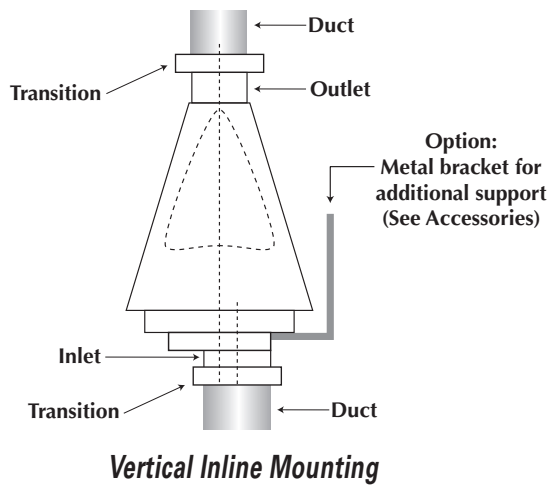

JET with optional Wall Mounting Bracket



Available Heights

- 12"
- 14"
- 18"
- 24"

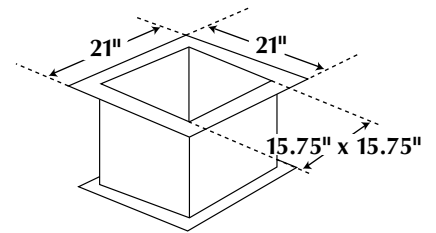

Roof Curb Sizing for Guidance Only
*Not Included

Dimensions (in)									
A	B	D	E	F	G	H	M (ID)	X	Y
23.62	33.25	6.30	1.93	9.87	6.31	4.50	21.25 x 21.25	11	11.81