

SCAN FOR BILT: 3D INSTRUCTIONS



Powered by BILT Intelligent Instructions®

Installation  
Instructions

# ELECTRONIC IGNITION FIRE PIT INSERT

SCAN FOR BILT: 3D INSTRUCTIONS



Powered by BILT Intelligent Instructions®

Troubleshooting  
Instructions



PENTA24EI

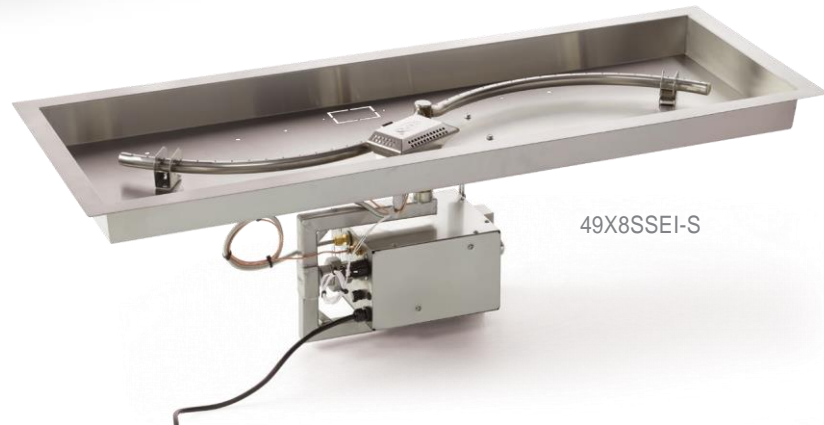

49X8SSEI-S

## EI Series

On/Off Models

Installation & Operation Instructions



C US



Before you begin >>>

3D INTERACTIVE INSTRUCTIONS FOR THIS PRODUCT ARE IN

**BILT.**  
Intelligent Instructions

DOWNLOAD THE FREE APP

Download on the App Store | GET IT ON Google Play



**FIRE INSPIRED™**  
Hearth Products Controls  
Fire-inspired since 1975.  
860-EI ON/OFF



**This is a Safety Alert Symbol**

When you see this symbol on the fire pit insert, or in this manual, look for one of the following signal word panels alerting you to the potential for personal injury, death or major property damage.



**WARNING: For Outdoor Use Only.**

**Installation and service must be performed by a qualified installer, service agency, or the gas supplier.**



**WARNING**

**Do not store or use gasoline or other flammable vapors and liquids in vicinity of this or any other appliance.**

**An LP-cylinder not connected for use shall not be stored in the vicinity of this or any other appliance.**



**DANGER**

**FIRE OR EXPLOSION HAZARD**

**If you smell gas:**

- **Shut off gas to the appliance.**
- **Extinguish an open flame.**
- **If odor continues, leave the area immediately.**
- **After leaving the area, call your gas supplier or fire department.**

**Failure to follow these instructions could result in fire or explosion, which could cause property damage, personal injury, or death.**



**DANGER**

**CARBON MONOXIDE HAZARD**

**This appliance can produce carbon monoxide which has no odor.**

**Using it in an enclosed space can kill you.**

**Never use this appliance in an enclosed space such as a camper, tent, car or home.**



**INSTALLER: Leave this manual with the appliance.**

**CONSUMER: Retain this manual for future reference.**



**WARNING: If the information in this manual is not followed exactly, a fire or explosion may result causing property damage, personal injury, or loss of life.**

# Table of Contents

---

<b>1 Important Safety Information</b> .....	3
Technical Support .....	3
Symbol Legend .....	4
Important Safety Information for Installers .....	5
Important Safety Information for End-Users.....	6
<b>2 Product Features and Parts List</b> .....	7
<b>3 Selecting the Fire Pit Location</b> .....	8
<b>4 Overhead Structures and Sidewall Clearance Requirements</b> .....	9
<b>5 Fire Pit Enclosures Requirements</b> .....	11
<b>6 Installing the Fire Pit</b> .....	13
<b>7 Adding Approved Media</b> .....	15
<b>8 Operating the Fire Pit</b> .....	17
<b>9 Maintaining the Fire Pit</b> .....	19
<b>10 Troubleshooting</b> .....	20
<b>11 Wiring Diagram</b> .....	21
<b>12 Compatible Accessories</b> .....	22
<b>13 Replacement Parts</b> .....	22
<b>14 Warranty</b> .....	24

# 1 Important Safety Information

---

- Hearth Products Controls Company recommends that our products are installed by professionals locally licensed by the authority having jurisdiction in gas piping. All installation instructions must be followed to ensure proper performance and safety. Hearth Products Controls Company assumes no responsibility for problems relating to the installation.
- To qualify for warranty, all instructions must be strictly followed. Otherwise, warranty may be void. Never alter product or configuration in any way.
- Annual servicing should be handled by professionals certified in the US by the National Fireplace Institute (NFI) as NFI Gas Specialists or in Canada by WETT (Wood Energy Technical Training).
- It is the installer's responsibility to ensure a safe installation and to educate the end-user regarding the features, safety recommendations and proper operation of this product.
- Please reference page 1 for all warnings.

**INSTALLER:**

Leave this manual with the appliance.

**END USER:**

Retain this manual for future reference.

**SELECT MODELS**

Certified to  
**ANSI Z21.97-2014**  
**CSA 2.41-2014**



---

## Technical Support

For information and support contact your Hearth Products Controls dealer.

# 1 Important Safety Information

---

## Symbol Legend



### This is a Safety Alert Symbol

When you see this symbol on the fire pit insert, or in this manual, look for one of the following signal word panels alerting you to the potential for personal injury, death or major property damage.



Necessary instructions



# 1 Important Safety Information

---

***Please reference page 1 for all warnings.***

## Important Safety Information for Installers

Leave this manual with the end-user and instruct them to retain it for future reference. Instructions and product updates are also available at [www.hpcfire.com](http://www.hpcfire.com) under the Support tab.

Installers must carefully follow the instructions in this manual to prevent personal injury or property loss. These instructions contain information critical to the safe installation and operation of the fire pit.

- Instructions are updated as needed. It is the responsibility of the installers to check for product updates and installation manual updates at [www.hpcfire.com/support.html](http://www.hpcfire.com/support.html) prior to installation.
- It is the responsibility of the installer to follow:
  - The National Fuel Gas Code, ANSI Z223.1/NFPA 54 or International Fuel Gas Code.
  - Natural Gas and Propane Installation Code CSA B149.1 or CSA B149.2.
  - The National Electrical Code, ANSI/NFPA 70. In Canada, Canadian Electrical Code CSA 22.1.
  - Local codes
- **Control options:** Use of wall switch, optional remote control (#578-C), automatic shut-off timer or whole house system.

## Gas

- Only use the gas/fuel type specified for this fire pit, refer to the label on the fire pit control box. Never use an alternative fuel to include biofuel, ethanol, lighter fluid or any other fuel.
- Gas pressure and type should be checked prior to use and installation.
  - **Natural Gas Fire Pit:** Supply Pressure: Minimum: 6.0 inches W.C.; Maximum: 7.0 inches W.C.
  - **LP Gas:** Supply Pressure: Minimum: 8.0 inches W.C.; Maximum: 11.0 inches W.C.

**IMPORTANT**

**If pressure is low, this will reduce flame height on HIGH setting, possibly resulting in little to no flame variation.**

# 1 Important Safety Information

---

- If not using supplied flex line, ensure any flex line that may be used from the permanent main fuel supply to the product is rated to the stated max BTU of the product and certified to ANSI Z21.75\*CSA 6.27.
- The EI Series is not for use with small LP Tanks and must utilize permanent fixed piping for fuel supply.

## Electrical

- Verify correct 120 VAC – 1 amp or 24 VAC – 4 amp power supply. Only use the type specified for this fire pit. Refer to the label on the fire pit control box. All electronic applications should utilize a GFCI-protected circuit.
  - If removing power cord plug and hard wiring within junction box, use only a certified Electrician and must follow the National Electrical Code (NEC), NFPA 70 and all local codes.

### IMPORTANT

#### 24 VAC powered fire pit inserts:

- Fire Pit will not perform properly if power supply rating is below 100W or wire size is too small.
- HPC highly recommends using our HPC/Sebco 24 VAC 100W power supply series (311-PS1, 311-PS3, 311-PS5 Models)

A Class II 24 VAC, 4 amp, 100 W transformer must be used to power the fire pit and be able to be switched on and off from a remote location to allow for easy access or emergency.

- 24 VAC wire sizing: Wire lengths 75 ft or less: 14 gauge
- Wire lengths 76 ft or more: 12 gauge

## Important Safety Information for End-Users

- Never leave an operating fire pit unattended or with someone not familiar with its operation or emergency shut-off locations.
- Both children and adults should be alerted to the hazards of high surface temperatures and should stay away to avoid burns and clothing ignition.
- Young children should be carefully supervised when they are in the area of fire pit.
- Keep the appliance area clear and free from combustible materials, gasoline, and other flammable vapors and liquids.

## 2 Product Features and Parts List

---

### Product Features

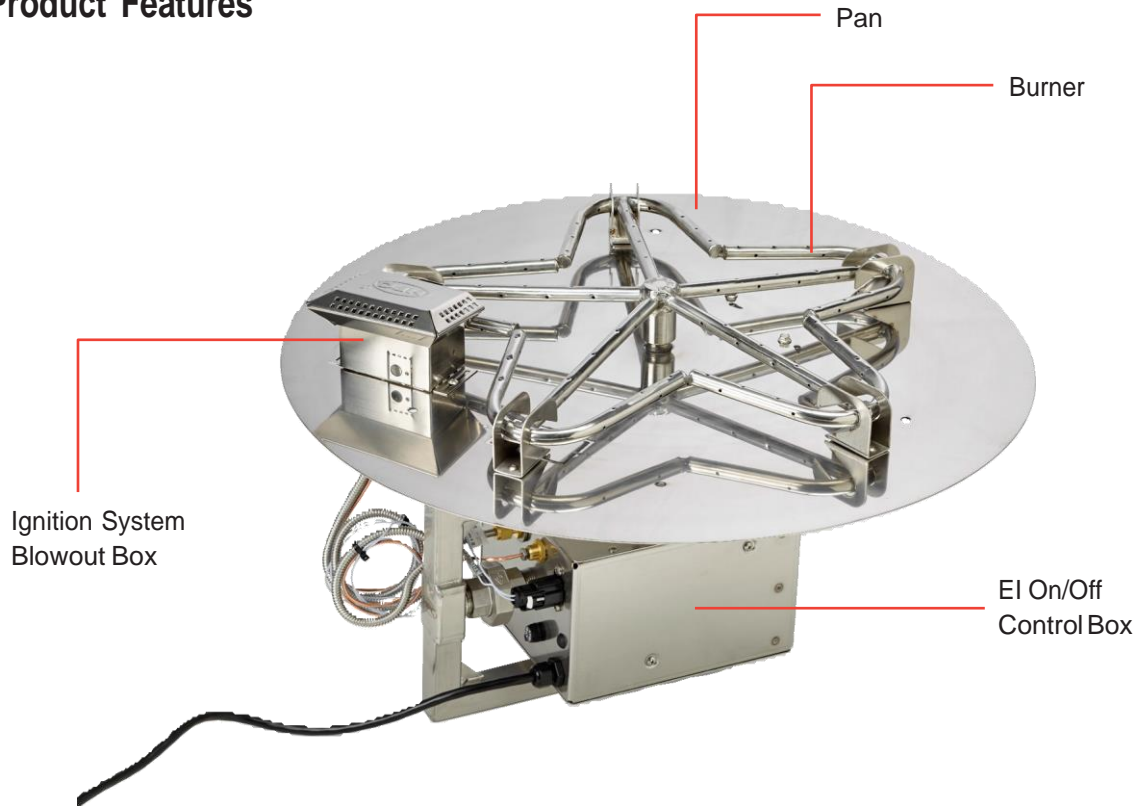

### Parts List

- Fire Pit Insert
- Gas Input Flex Line – 24"
- Installation and Operation Instructions



### 3 Selecting the Fire Pit Location

---

**NOTE:** All fire pits and systems are designed and intended for outdoor use only.

**IMPORTANT**

It is recommended that material such as granite, marble or other dense stone be kept away from heat and especially flame due to risk of cracking. HPC is not responsible for damage resulting from failure to follow these recommendations.

- Select a location that
  - ensures above-grade installation of the fire pit.
  - offers good drainage.
  - allows easy access for installation and maintenance of the fire pit.
  - provides sufficient horizontal room to enjoy the fire pit while allowing a safe distance from the heat and flame.

**IMPORTANT**

**Deck installation — If installing fire pit on a wood or composite deck, it is required to use the Deck Insulation Kit(s) and locally bought paver stones. Kit includes basalt material and instructions.**

**#FPI-DECK39SQ; #FPI-DECK20SQ. Also refer to drawing- Deck Insulation Kit- Install.**

- Fire pits create very high temperatures. For clearances refer to table 3.1. Clothing or other flammable materials should not be placed on or near fire pit.

#### Clearances around Fire Pit

Fire Pit Clearances	Up to 200k BTU	201k ~ 400k BTU
Under Valve Box when applicable for drainage	2"	2"
Sides surrounding fire pit from structure or combustibles	36" (12" for noncombustibles)	48" (24" for noncombustible)
Overhead clearance above product	84"	Non-combustible screen only

Table 3.1 – Fire Pit Clearances

# 4 Overhead Structures and Sidewall Clearance Requirements

It's important to review the clearance requirements below for any type of overhead structure such as pergola, roof, overhang, screens, arbor, etc. or a sidewall to ensure that the distances are met. Figures 4.1 and 4.2.

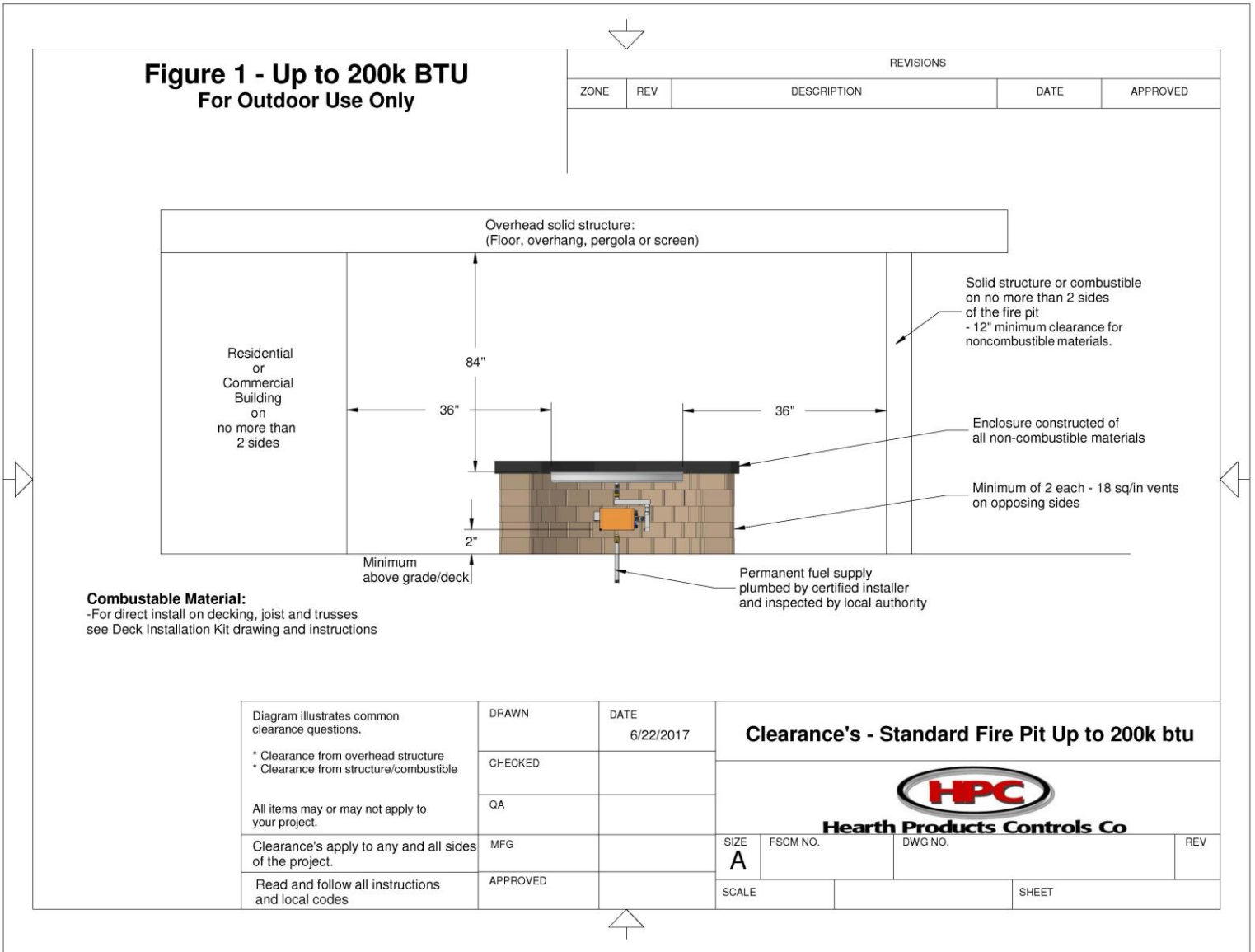
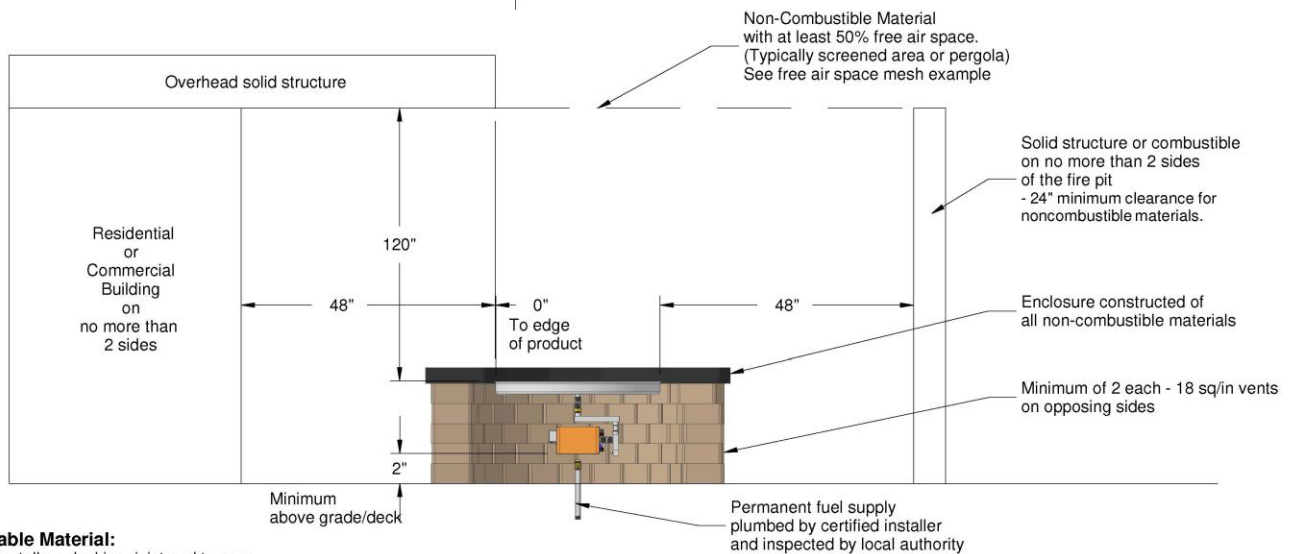

Table 4.1 – Clearances for standard fire pit up to 200k BTU

# 4 Overhead Structures and Sidewall Clearance Requirements

**Figure 2 - 201k to 400k BTU  
For Outdoor Use Only**



**Combustible Material:**  
-For direct install on decking, joist and trusses  
see Deck Installation Kit drawing and instructions

**Note:**  
-50% free air space minimum. HPC is not responsible for screen that melts.  
-For non-combustible screening a 20 x 20 x .013 wire mesh thickness or courser. (More open space)  
-For all other non-combustible coverings an on-site estimate of free air space will be necessary.

**Free Air Space Mesh Example**  
3:1 Scale of 20x20x.013

Diagram illustrates common clearance questions.  * Clearance from overhead structure * Clearance from structure/combustible  All items may or may not apply to your project.  Clearance's apply to any and all sides of the project.  Read and follow all instructions and local codes	DRAWN	DATE
	CHECKED	6/22/2017
	QA	
	APPROVED	

<b>Clearance's - Standard Fire Pit 201k to 400k btu</b>			
			
<b>Hearth Products Controls Co</b>			
SIZE	FSCM NO.	DWG NO.	REV
A			
SCALE		SHEET	

Table 4.2 – Clearances for standard fire pit up to 201k to 400k BTU

## 5 Fire Pit Enclosures Requirements

---

### Location and design

- The enclosure must be installed above-grade and allow for drainage to prevent water damage to fire pit.
- Refer to cut sheets on our website for important dimensional information for your fire pit. Visit [www.hpcfire.com](http://www.hpcfire.com)
- The fire pit assembly should be recessed a minimum of two inches from the top of the enclosure to protect flame from being blown out.
- It is recommended that material such as granite, marble or other dense stone be kept away from heat and especially flame due to risk of cracking. Manufacturer is not responsible for damage.
- The enclosure must be constructed on a stable surface and be level. HPC recommends the use of the installation collar (optional) that may be mortared into or sandwiched between layers of the enclosure.
- The weight of the fire pit must be supported by the pan and not by any control/valve box.
- HPC recommends that the pan lip is recessed on a trough (linear), and large round enclosures, Figure 5.1.

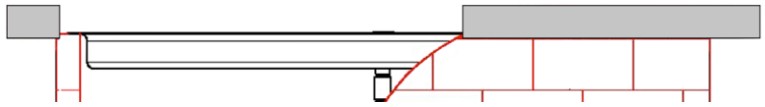

Figure 5.1 – Pan lip recessed on a trough.

**NOTE: HPC cannot guarantee the lip on all of our products will be perfectly flat and will not warp due to heat.**

- There must be a minimum of 2 inches under the valve box for proper ventilation and drainage, see clearance drawings on page 9 and 10.
- The product must be accessible for service.

### Gas

- Fire pit must have a gas shutoff on the exterior of the fire pit to allow for emergency shut off and maintenance. The gas shutoff should NOT be used to adjust flame height.
- Fuel line sizing is the responsibility of the installer and must be able to supply the stated maximum BTU for the product – refer to product label on fire pit.

## 5 Fire Pit Enclosures Requirements

---

### Construction materials

- Use non-combustible materials and construction for gas supply, power and enclosure.
- The interior void space of the enclosure surrounding the valve box cannot be filled with any material (gravel, crushed rock, concrete, etc.).

### Venting

- The enclosure must incorporate at least two vents to allow heat and or residual fuel to escape. Failure to properly vent the enclosure may result in the fire pit overheating or explosion.
- Some enclosures may require more ventilation based on material, size, and extended use.
- The vent may also work as a drain when installed at bottom sidewall to prevent water build up.
- Vent specifications:
  - A minimum of two vents (18 square inches for each vent) on opposing sides of the enclosure totaling 36 inches of free area are required (example: 3-inch x 6-inch or larger). Or, multiple vents uniformly made throughout the enclosure totaling 36 square inches or more of free area are acceptable.
  - We recommend 4 vents total to reduce the risk of thermal shutdown.
  - Installation of the vents in the mid-to-lower area of the enclosure is recommended.
- Failure to properly vent the enclosure may result in the fire pit overheating or explosion. Continuous overheating could lead to heat damage to internal components.
- When installing insert inside a non-HPC copper or concrete bowl, ventilation should be below the bowl. If bowl is mounted on top of a column, a 6" hole is recommended to allow gas supply, electrical and water plumbing to clear.
- **OVERHEATING:** the fire pit will automatically close the gas valve if the temperature exceeds 190°F inside the valve box to prevent component damage. Turn main power to the fire pit off and on to reset. To correct overheating, ensure enclosure has adequate ventilation per the guidelines in this section.

## 6 Installing the Fire Pit

---

### Fuel line

- Fire pit must have a gas shutoff on the outside of the exterior of the fire pit to allow for emergency shut off and maintenance. The gas shutoff should not be used to adjust flame height.
- The installer is responsible for using the correct fuel line sizing that is able to supply the stated maximum BTU for the product – refer to product label on the fire pit for specifications.

#### INSTALLATION

We suggest that our products be installed by professionals that are locally licensed by the authority having jurisdiction in gas piping.

- Perform all leak tests with leak detector or leak reactant.

#### IMPORTANT

To prevent damage, unhook the fire pit from the gas supply for pressure leak tests of the supply line.

#### IMPORTANT

**Burn Testing:** It is the responsibility of the qualified installer to test for gas leaks at all connections.

#### IMPORTANT

**Gas Plumbing Connections:** Use joint compound or tape that is resistant to all gases. Apply joint compound only to all male pipe fittings. **DO NOT use on flex line flared fittings.** Be sure to tighten every joint securely.

#### Installation Steps:

1. Set fire pit in properly constructed enclosure, read **Section 5 – Fire Pit Enclosure Requirements**.
2. Position fire pit following safety recommendations with access to all gas connections for testing. Read **Section 3 – Selecting the Fire Pit Location** for more details.
3. Shut off gas supply to fire pit.
4. Connect proper 120 VAC or 24 VAC electrical power following all local codes.
5. Connect fire pit to main gas supply. Warning: avoid sharp bends with flex line to prevent whistling.

## 6 Installing the Fire Pit

---

6. Turn on gas supply, purge gas lines of air and perform leak test on all inlet connections. Repair as needed.
7. Initial Start-up after install:  
Several "ON/OFF" cycles may be necessary to purge air in gas lines after system installation.
  1. Turn "ON" gas to fire pit.
  2. Remove Blowout Box lid to allow viewing of hot surface igniter
  3. Turn "ON" electrical power to fire pit via wall switch or breaker.
  4. Hot surface igniter should begin to glow within 10 seconds.
  5. Pilot flame will eventually igniter. NOTE: This may take several cycles due to air in the gas line. Unit will lockout after 15 cycles- to reset, please turn "OFF" electrical power using wall switch or breaker then turn "ON", repeat step 4.
  6. Main burner will igniter.
8. Once fire pit is lit, perform leak test on all gas connections. Repair as needed.

### IMPORTANT

**For Penta Burner inserts, flame will be smaller with no media on the burner.**

9. Turn off fire pit and allow it to cool.
10. Apply media as described in **Section 7, Adding Approved Media**. When filling the pan with lava rock and/or decorative glass, the instructions in Section 7 must be followed.
11. Turn on fire pit again and perform leak test with media correctly installed. If gas leak is detected verify correct media application and repair as needed.
12. Verify correct operation and lighting.
13. Review safety manual with end-user. Instruct end-user that fire pit or media must not be changed or modified.
14. Leave manual with end user.
15. Apply the Start Up and Shutdown decal next to control box in an obvious and highly visible position.

## 7 Adding Approved Media

---

### WARNING

FOR GLASS MEDIA USAGE WITH LP GAS - WHEN USING APPROVED DECORATIVE GLASS TO COVER BURNER APPLY ONLY ENOUGH TO HIDE BURNER. APPLYING OVER 1/2" MAY CREATE BACK PRESSURE AND GAS LEAKAGE FROM AIR MIXER RESULTING IN LP POOLING UNDER FIRE PIT.

### WARNING

FOR GLASS MEDIA USAGE WITH LP GAS - THE UNIT MUST BE TESTED WITH MEDIA OVER BURNER FOR CONFIRMATION OF NO BACK PRESSURE CREATING GAS TO LEAK OUT OF AIR MIXER VENTURI HOLES. THIS MAY HAVE TO BE DONE PRIOR TO PLACING IN ENCLOSURE IF NO ACCESS DOOR.

### WARNING

Never use any material that is non-porous or holds moisture such as gravel, pebbles, river rock, etc. When heated, non-porous material will not allow heated steam to readily escape which can break and cause personal injury or damage. Material that holds moisture can boil and fracture unexpectedly when exposed to heat.

### IMPORTANT

The fire pit is designed to use approved media correctly installed over the burner to achieve proper combustion.

- Never install a mesh or screen under the media.
- Media affects flame pattern greatly. It is possible to create an unusual flame pattern that could damage your enclosure. Enclosure damage from an open flame fire feature is not covered under any warranty.
- The use of concrete logs is not recommended.









# 7 Adding Approved Media

## Application of Approved Media

Please follow the instructions below to add the finishing touch to your fire pit.

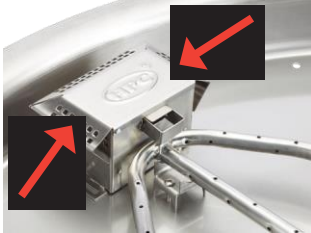
Particular attention needs to be on the pilot assembly area.

Incorrect media installation will cause the pilot flame to suffocate and turn off pit or delay main burner ignition.

Lava Rock Only Application	Decorative Glass Application
<p>1) Install your fire pit per instructions.</p>  <p>2) Apply lava rock ONLY deep enough to cover ring.</p>  <p>3) Blowout Box: Leave vents open. Do not cover vents with lava rock or allow any rock to block flame opening. Incorrect media installation will cause the pilot flame to suffocate and turn off pit or delay main burner ignition.</p>  <p>Do not cover box vents!</p>	<p>1) Install your fire pit per instructions.</p>  <p>2) Fill pan with media. Cover burner with 1/4 to 1/2 inches of glass. Do not overfill pan with glass. All LP installations must be checked for back pressure with media installed. Failure to do so may result in personal injury or property damage.</p>  <p>3) Blowout Box: Do not cover blowout box vents or opening with glass. Incorrect media installation will cause the pilot flame to suffocate and turn off pit or delay main burner ignition.</p>  <p>Do not cover box vents!</p>

## 8 Operating the Fire Pit

---

- Before use, be sure to test all gas connections for leaks. Do not use fire pit if there is any evidence of leaking gas. If leaking gas suspected, turn off the main gas supply and repair immediately.
- Do not use the enclosure as a seating area. Wind and gusty conditions will affect the flame in an unpredictable manner. If conditions exist that are not safe for patrons, turn off the fire pit.
- The hose should be inspected before each use of the fire pit and replaced prior to use if there is evidence of excessive abrasion or wear or if the hose is damaged. The replacement hose assembly shall be that specified by the manufacturer.
- Do not use the fire pit if any part has been under water. Immediately call a qualified service technician to inspect the fire pit and to replace any part of the control system and any gas control that has been under water.
- Never use any material that is non-porous and holds moisture such as gravel, pebbles, river rock, etc. This material, when heated will cause the trapped moisture to boil and fracture unexpectedly. This material is not sufficiently porous to allow heated steam to readily escape which can break and cause personal injury or damage.
- Solid fuels shall not be burned in the fire pit.
- Leaves, sticks, wood, paper, clothing, food material, should be kept away from the fire pit. Clothing or other flammable materials should not be hung from the appliance or placed on or near the appliance. Keep the appliance area free from gasoline, and other flammable vapors and liquids.
- Fire pit is not for cooking.
- Make sure that there is no vegetation or other objects over the top or sides of the fire pit that could interfere with safe operation. See clearances in **Section 3 – Selecting the Fire Pit Location**.
- If lava rock is wet, allow the fire pit to burn for 45 minutes prior to coming within 15 feet of the fire pit.
- When the fire pit is not in operation, turn off gas valve.
- When not in use, the fire pit must be covered at all times.

## 8 Operating the Fire Pit

### Start-up

**Initial Start-up:** Several "ON/OFF" cycles may be necessary to purge air in gas lines after system installation. Fire pit will lockout after 15 attempts to light pilot, please power OFF then ON to restart.

#### Sequence of Operation:

1. The igniter will be powered (glow red) for five seconds before pilot valve opens.
2. The igniter will only be powered the initial 15 seconds of the 30-second pilot cycle. This sequence will repeat up to 15 times (approximately 15 minutes) before going into lockout. To reset, turn "OFF" power then back "ON" again.
3. Pilot flame will ignite and warm thermocouple; it may take 30 seconds at times for thermocouple to get hot. If thermocouple is not hot in 60 seconds, system will shut down. If this occurs, go back to Step 1.
4. Once thermocouple is hot, main valve will open allowing main burner to ignite.
5. If pilot flame is blown out at any time, system will shut down, and then automatically restart (Step 1).



### DANGER

#### If you smell gas:

- 1) Shut off gas to appliance.
- 2) Extinguish any open flame.
- 3) If odor continues, keep away from appliance and immediately call gas supplier or fire department.

### EI Fire Pit Start Up

1. **STOP! Read the safety information on "What to Do If Smell Gas" (Pg. 1).**
2. Confirm there is no debris in the fire pit (as mentioned in warnings) including water.
3. Turn "ON" electrical power and gas to fire pit.
4. Using wall switch to turn "ON" fire pit - this may take several cycles to purge any air.
5. To reset after lockout, power unit down, wait 5 minutes, then restart.
6. Once the fire pit has ignited **DO NOT** leave unattended.

**This product is not for use with small tanks.**

### EI Fire Pit Shutdown

1. Turn "OFF" fire pit using remote, wall switch or app.

#### IMPORTANT

**FOR REMOTE CONTROL USE, YOU MUST ALSO TURN OFF POWER TO ELECTRICAL OUTLET OR GAS TO FIRE PIT TO PREVENT ACCIDENTAL START.**

2. Once fire pit is cooled, use appropriate cover to protect fire pit.

## 9 Maintaining the Fire Pit

- Any guard or protective device removed for servicing must be replaced prior to operating the fire pit.
- We suggest that our products be serviced annually by a professional certified in the US by the National Fireplace Institute (NFI) as NFI Gas Specialists.
- Ensure gas is shut off and fire pit is cool before servicing.
- Keep fire pit covered at all times when not in use and free of debris.
- In some areas of the country, spiders or insects have been known to build nests and/or lay eggs in the venturi holes of the air-mixer for LP units. This can cause fuel to fill the fire feature cavity and result in personal injury or property damage. Periodic inspection by a qualified service technician of the air-mixer is required to ensure your fire feature performs properly, Figure 9.1.
- **Burner Cleaning: One time a year.** If flames exhibit any abnormal shapes or behavior, or if burner fails to ignite properly, then the burner holes may require cleaning. The appliance can be cleaned by carefully removing the logs and media to allow access to burner. Use a brush to carefully remove dust, spider webs, and loose particles from base, logs, and fire ring itself. If evidence of damage, fire ring must be replaced with fire ring specified by the manufacturer.
- **Thermocouple cleaning of soot: Once every six months or as needed.** Remove lava rock & glass around pilot, then the blowout box lid. Clean thermocouple of any soot using soft brush. Be careful not to damage hot wire element. Place lava rock or glass back as explained in **Section 7 – Adding Approved Media.**
- Always ensure that the union fitting is tight. If loose, torque until there is no leak (recommended torque value of 80 ft lb).
- **Visually inspect the pilot.** The pilot flame should cover 3/8 inch to 1/2 inch of the thermocouple, Figure 9.2. Cleaning of the pilot orifice may be required by removing pilot hood counter clockwise and removing orifice, Figure 9.3.

### Service



We suggest that our products be serviced by a professional certified in the US by the National Fireplace Institute (NFI) as NFI Gas Specialists.



Figure 9.1 – Locating orifice for cleaning



Figure 9.2 – Pilot flame coverage of thermocouple.



Figure 9.3 – Cleaning pilot orifice

# 10 Troubleshooting

Table 10.1, below indicates some potential causes and countermeasures to the symptoms indicated in bold type. **Please contact your retailer or certified technician for service and repair.**

- The error number and description are shown by the number of LED blinks on the module inside of the valve box.

## Service



We suggest that our products be serviced by a professional certified in the US by the National Fireplace Institute (NFI) as NFI Gas Specialists.

Error Number & Description	Problem	Possible Causes	Solution
<b>1</b> Igniter failure <b>6</b> Igniter open	<b>Pilot Will Not Light</b>	Air in gas line	New install – May take several attempts
		No gas flow – Gas not ON or line obstruction	Confirm gas is ON upstream Possible debris in line – insulation, dirt, plastic, etc.
		Pilot orifice dirty or clogged	Remove orifice and clean (Section 9)
		Gas pressure improper	Confirm proper gas pressure (Section 1)
		Igniter element damaged	Change igniter element
		Damaged wires	Inspect wires to igniter. Confirm insulation is in good condition and connections are tight
<b>3</b> Thermocouple error <b>4</b> Hardware fault pilot/main valve <b>5</b> Flame at startup	<b>No Main Burner (Pilot Flame Present)</b>	Loose thermocouple at the valve box	Tighten down connection at valve box. Should be tightly snug.
		Thermocouple cracked/broke under pilot assembly	Replace thermocouple
		Gas pressure improper	Confirm proper gas pressure (Section 1)
		Small pilot flame	Remove pilot head and clean orifice (Section 9)
		Dirty thermocouple	Clean using soft brush
		Fire ring obstructed	Confirm no debris or water in ring
		Improperly applied media	See Section 7.
Pilot flame present at all times	Possible debris inside valve		
	<b>Main Burner Turning Off/On Frequently</b>	Small pilot flame	Remove pilot head and clean orifice (Section 9)
		Improperly applied media	See Section 7.
		Gas pressure improper	Gas pressure too low (Section 1)
		Thermocouple defective	Change thermocouple
<b>2</b> Over temperature  <b>10</b> Internal control fault or Over temperature	<b>No Power or Response from Unit</b>	No power to unit	Confirm breaker, wall switch and remote are on
		Remote not working	Change batteries Re-sync remote (High/Low models only)
			Check external fuse (5A)
		Has power to unit but will not cycle	Check voltage to unit Module sensing wrong voltage. Replace module and transformer
		Over temperature	Inadequate venting see proper venting in Section 5. Power OFF then back ON to reset

Table 10.1 – Troubleshooting

# 11 Wiring Diagram

## 120VAC Models:

(Included in fire pit control box)

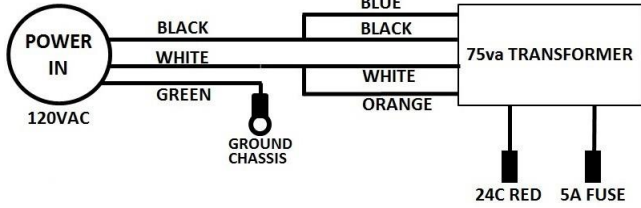

## 24VAC Models:

(Power supply sold separately)  
311-PSI, 311-PS3, 311-PS5

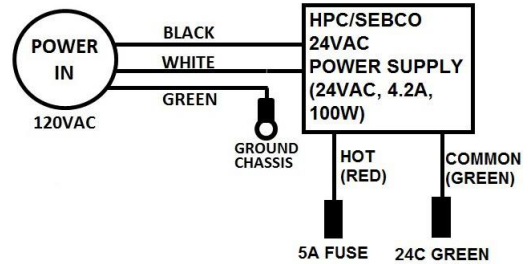

NOTE: 100W Output Required

## Both Models:

- All wire - 18 AWG, °200C, 600V
- 1/4" fully insulated female spade terminal, 22-16 AWG 250a, x 11 (color red)
- #6 Ringlet Terminal 22-16 AWG
- Zip tie - Nylon 66 UV stable miniature, 3" length

HPC EI WIRE DIAGRAM  
120VAC / 24v

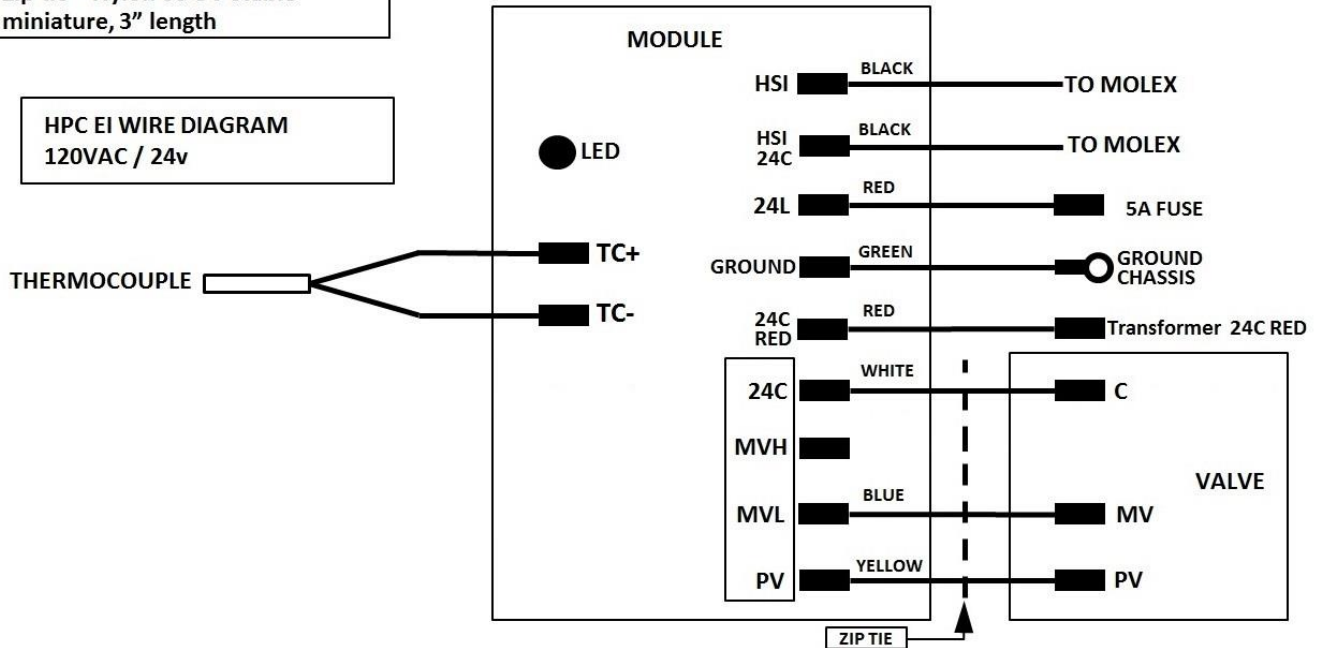

## 12 Compatible Accessories

- **Wind guards** – Clear glass wind guards protect flames from being blown out in windy conditions as well as personal belongings from being blown into the fire. Available in round, linear and square shapes. See Figure 12.1.
- **Fire pit cover** – Hearth Products Controls has decorative copper covers and heavy-duty vinyl covers for your fire pit that will protect it from rain, snow, and moisture. See Figure 12.2.

For a complete list of accessories, visit [www.hpcfire.com](http://www.hpcfire.com)



Figure 12.1 – Wind guard



Figure 12.2 – Fire pit cover

## 13 Replacement Parts

Please contact your dealer for parts – if unsure please contact HPC or visit our website at [www.hpcfire.com](http://www.hpcfire.com) and we will be happy to help you.

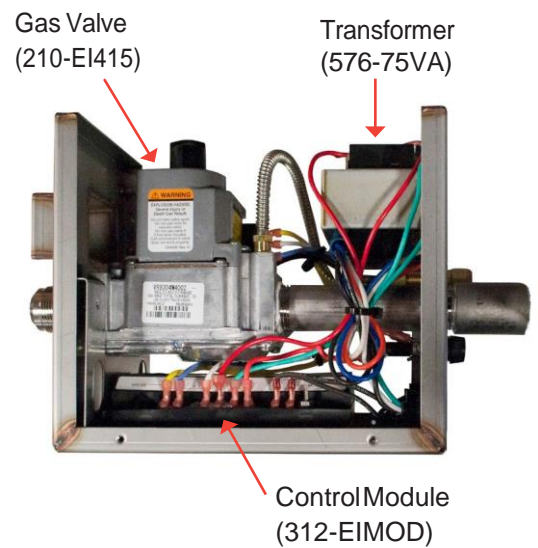
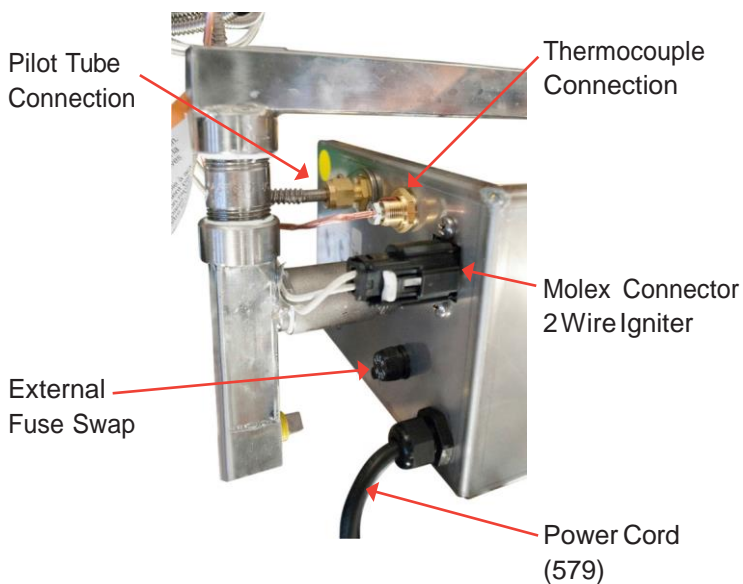

# 13 Replacement Parts

---

Pilot Assembly

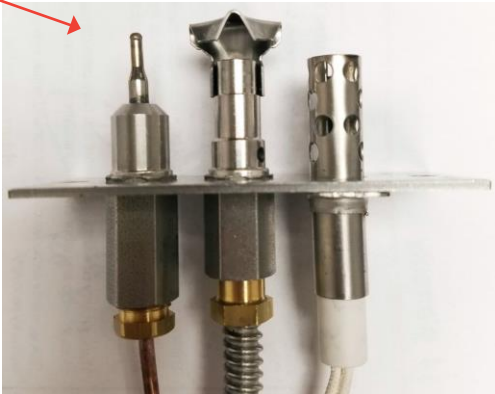

## EI Series Replacement Components

Part Number	Item
311-T/C	Thermocouple
312-IGNITER	Hot Surface Igniter
312-EIMOD	Control Module
210-EI415	Gas Valve
576-75VA	Transformer
579	120VAC Power Cord
Please Buy Local	Fuse (5A) – common fast acting

## Pilot Assembly

Part Number	Fire Pit Size	Gas
HSIP-36SS	50k ~ 275k BTU	NG
HSIP-36SS-300NG	300k BTU	NG
HSIP-36SS-400NG	400k BTU	NG
HSIP-36SS-50/225LP	50k ~ 225k BTU	LP
HSIP-36SS-250 / 400LP	250k ~ 400k BTU	LP



# 14 Warranty

---

## Warranty

Hearth Products Controls Co. (HPC) warrants fire pits against manufacturing defects that prevent safe and correct function as follows:

### 1) **Stainless Steel Fire Pit and Outdoor Fireplace Burners - Lifetime Warranty**

Limited Warranty:

- 2) Electronics, Gas Valve: Commercial-1 year; Residential-3 year.
- 3) Pilot Assembly: Commercial-1 year; Residential-2 year.
- 4) Stainless Steel Pan, Valve Box: Commercial-1 year; Residential-5 years

Warranty commences from the date of original sale / shipment from HPC FOB Dayton, Ohio. This warranty is for parts and in-house (HPC) labor. The defective product must be sent back to HPC with a Return Merchandise Authorization (RMA) issued by HPC for that specific product and any other additional information for the nature of the defect or warranty claim. The warranty does not cover items that have been damaged by overheating, modification, abuse, or improper storage. Also any labor involving installation or maintenance with the unit is not covered. This warranty excludes claims for consequential, indirect-collateral expenses arising from product defects or warranty recovery.

Rev.0 5/8/2019



**FIRE INSPIRED™**

**Hearth Products Controls**

**Fire-inspired since 1975.**

3050 Plainfield Road  
Kettering, Ohio 45432

For detailed product information, go to [www.hpcfire.com](http://www.hpcfire.com)