



OUTDOOR FIREPLACE

Outdoor Premium OP42FP

Spec Sheet



ACTUAL DIMENSIONS

44" W x 35 1/16" H x 19" D

INCLUDES

- Stainless Steel Hood
- Mesh Curtain
- Refractory Liner

REQUIRES

- 7-piece Wildwood Refractory log set

TECHNICAL INFORMATION

- Maximum heat output
50,000 BTU (LP or Natural)
- Weight: 168 lbs.
- Clearances:
SideWall: 6"
Side and Back: 0"
Front: 36"
- Type of Gas: LP or Natural
- Iron Pipe Size: 1/2-inch
- Ignition System: Intermittent Pilot or Millivolt

FIELD INSTALLED ACCESSORIES

- Bi-Fold Glass Door, 42-inch
Stainless Steel
- Drain Tray, 42-inch Stainless Steel
- Weather Door, 42-inch Stainless Steel

OP42FP

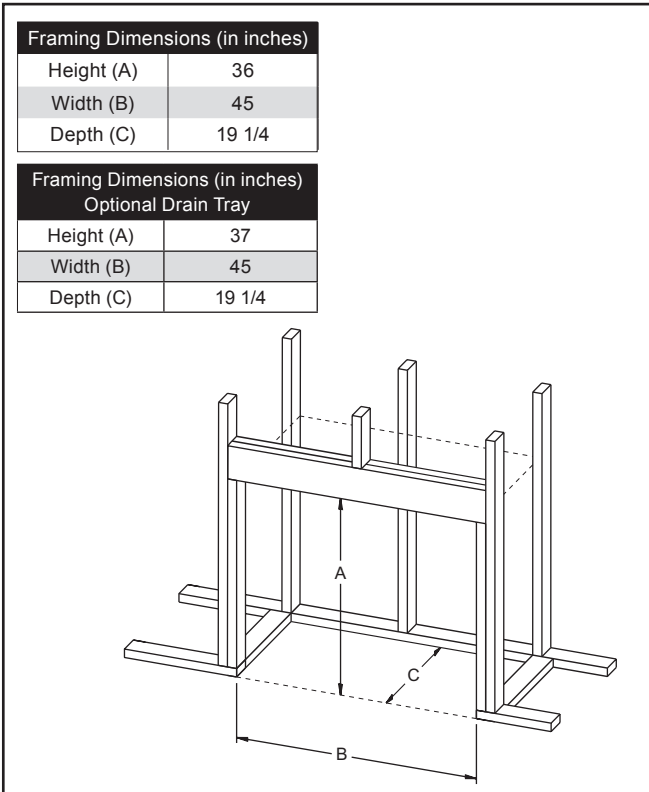
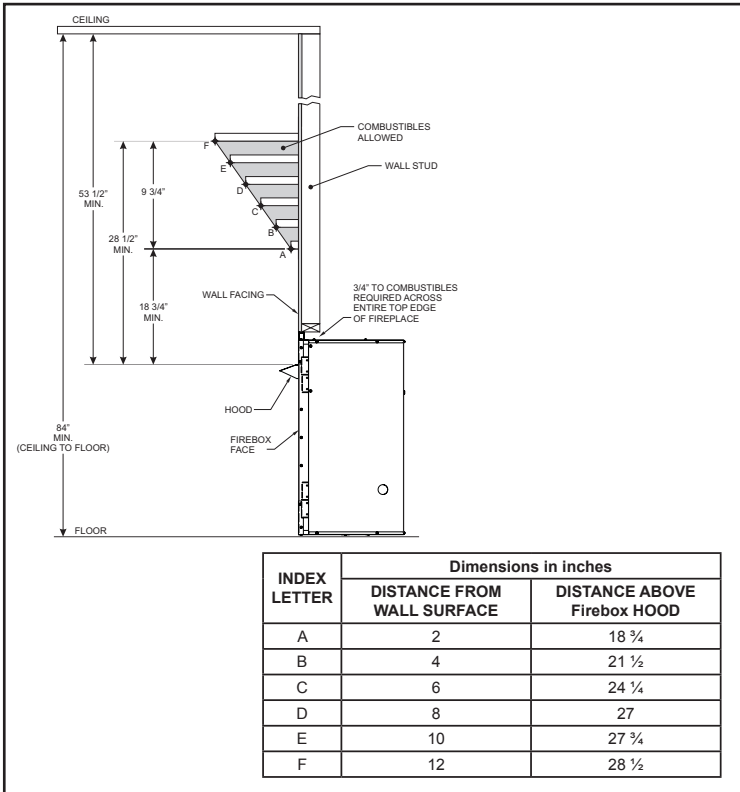
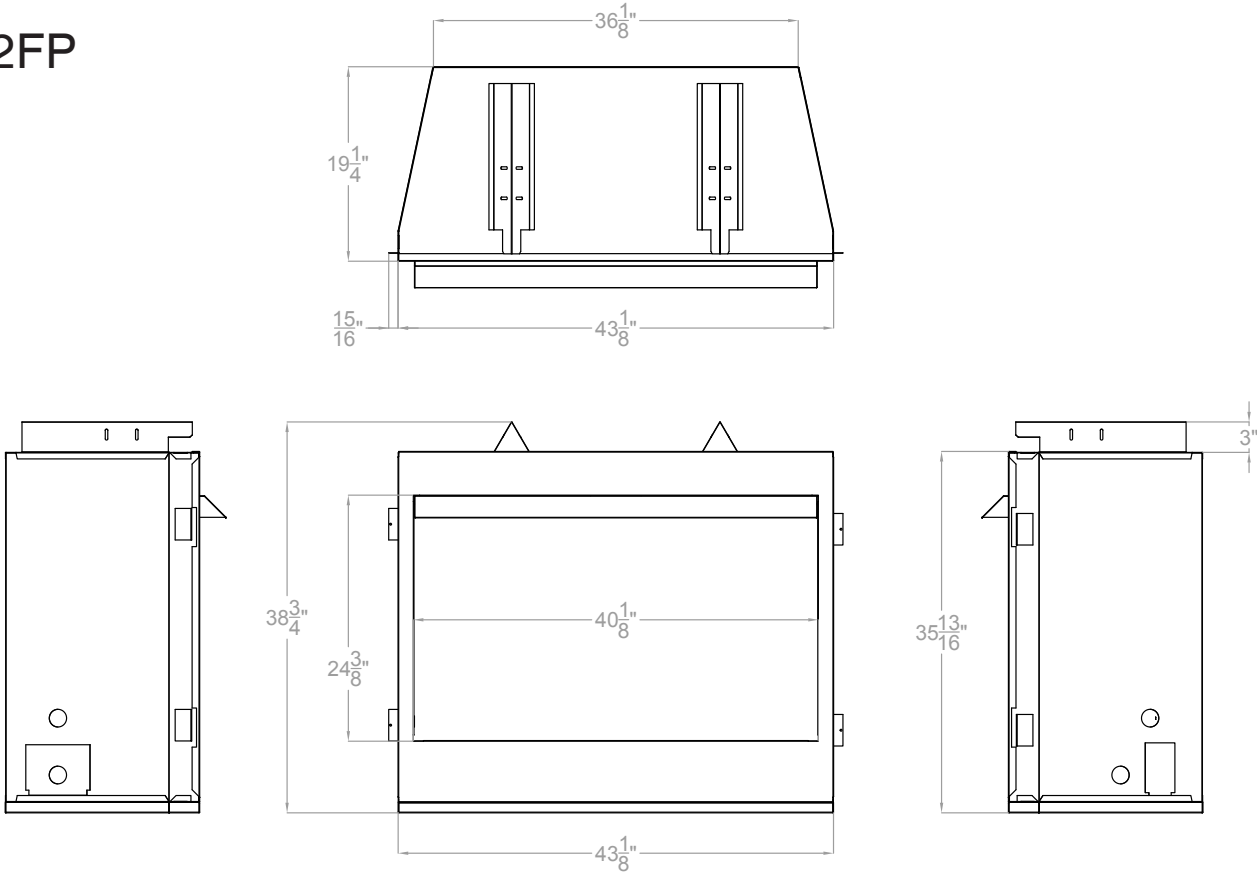

Empire is committed to continuous product improvement; specifications are subject to change without notice. Dimensions in this brochure are approximate; read and follow the framing dimensions in the owners manual supplied with your Empire product. Flame size, shape, and color will vary from photos. Our mantels feature natural veneers and hand-rubbed finishes – wood grain and color will vary. Adjust light levels and use "natural light" incandescent bulbs to enhance the dramatic look for your wooden mantel.

Member of the following industry associations:



The Empire Comfort Systems and White Mountain Hearth names and logos are registered U.S. trademarks.



SINCE 1932

Empire Comfort Systems Inc.
918 Freeburg Ave.
Belleville, IL 62220-2623
info@empirecomfort.com
01/18