

MAUNAL OF MODELS NB-BQ15, NB-BQ16, NB-BQ7 AND NB-BQ9 ENG

Operator's Manual NB-BQ15 (NB-BQ16, NB-BQ7, NB-BQ9) Wood Pellet Grill

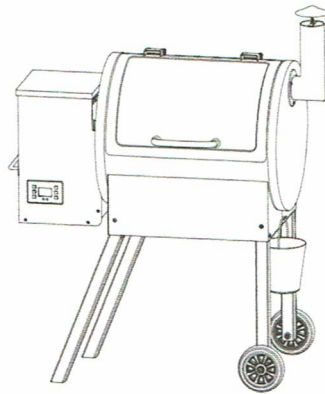

RESIDENTIAL PELLET GRILL FOR OUTDOOR USE ONLY!

PLEASE READ THIS ENTIRE MANUAL BEFORE INSTALLATION AND USE OF THE PELLET FUEL-BURNING APPLIANCE. FAILURE TO FOLLOW THESE INSTRUCTION COULD RESULT IN PROPERTY DAMAGE, BODILY INJURY OR EVEN DEATH. CONTACT LOCAL BUILDING OR FIRE OFFICIALS ABOUT RESTRICTIONS AND INSTALLATION INSPECTION REQUIREMENTS IN YOUR AREA.

A MAJOR CAUSE OF FIRES IS FAILURE TO MAINTAIN REQUIRED CLEARANCES (AIR SPACES) TO COMBUSTIBLE MATERIALS. IT IS OF UTMOST IMPORTANCE THAT THIS PRODUCT BE INSTALLED ONLY IN ACCORDANCE WITH THESE INSTRUCTION.

SAVE THESE INSTRUCTIONS

MAUNAL OF MODELS NB-BQ15, NB-BQ16, NB-BQ7 AND NB-BQ9 ENG (2 OF 22)

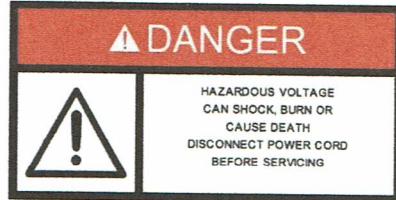

DANGER! Hazardous voltage is present which can shock, burn or cause death. Disconnect the power cord before servicing the Grill unless otherwise noted in the Owner's Manual.

DANGER! Never use or store flammable liquids near the Grill.

DANGER! Never use gasoline or lighter fluid to manually light your Grill. Use **ONLY** Alcohol Gel for this procedure **AND** according to the instructions in the Owner's Manual.

WARNING! When operating this Grill, maintain a **MINIMUM** distance of 12" from the Grill to combustibles.

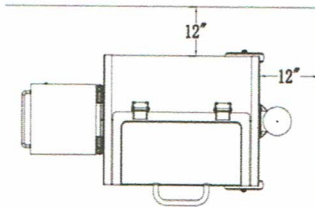

WARNING! Assemble and operate this Grill **ONLY** per the instructions in this Owner's Manual.

WARNING! This Grill is intended for **OUTDOOR USE** Only. Please keep the air circulation.

WARNING! Never use heating fuel pellets in the Grill, due to potential hazardous contaminants and additives that may be present.

CAUTION! Always store wood pellets in a dry location, away from heat-producing appliances and other fuel containers.

CAUTION! Keep the Grill clean – See the cleaning Instructions in this Owner's Manual.











CAUTION! Do not use accessories not specified for use with this Grill.

WARNING! THIS GRILL IS NOT SUITABLE FOR INSTALLATION ON COMBUSTIBLE FLOORS AND INSTALL UNDER A COMBUSTIBLE CEILING OR OVERHANG. FOR FLAMMABLE FLOOR SURFACES(WOOD , CARPET ,ECT.) A GLASS ,STEEL PLATE OR CERAMIC UNDERLAY IS REQUIRED .

WARNING! USE ONLY WOOD PELLET FUEL SPECIFIED BY THE MANUFACTURER. .DO NOT USE PELELT FUEL LABELED AS HAVING ADDITIVES

MAUNAL OF MODELS NB-BQ15, NB-BQ16, NB-BQ7 AND NB-BQ9_ENG (3 OF 22)

Hardware lists

- | | | |
|---|---|---|
|   |   |   |
| Ⓐ Bolt: M6*55 (8pcs) | Ⓒ Nut: M6 (11pcs) | Ⓔ Washer: $\varnothing 18 \times \varnothing 6 \times 1.5$ (18pcs) |
|   |   | |
| Ⓑ Bolt: M6*15 (7pcs) | Ⓓ Bolt: M6*30 (2pcs) | |

Grill parts diagram

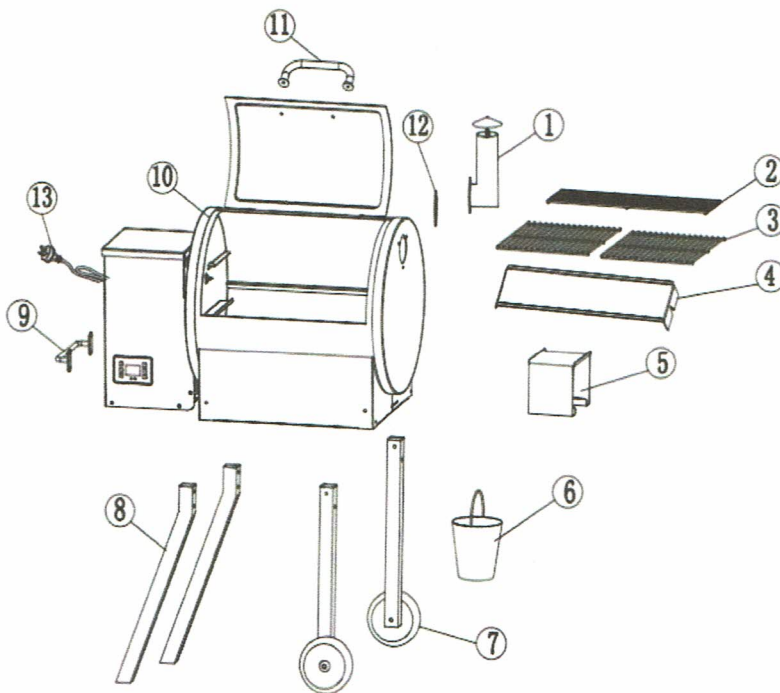

MAUNAL OF MODELS NB-BQ15, NB-BQ16, NB-BQ7 AND NB-BQ9 ENG (4 OF 22)

Part	Description	Part	Description
1	Flue Pipe	7	Wheel Legs×2
2	Warming Rack	8	Long Legs×2
3	Cooking Rack×2	9	Carry Handle
4	Grease Drip Tray	10	Grill Body
5	Heat Baffle	11	Handle
6	Grease Bucket	12	Heat Insulation Cotton
		13	Power Cord

Cleaning the chamber

1. Remove the warming grate, cooking grate; heat baffle and grease drip tray before you start using the grill, the surface grease of the cooking grill can be cleaned with water.

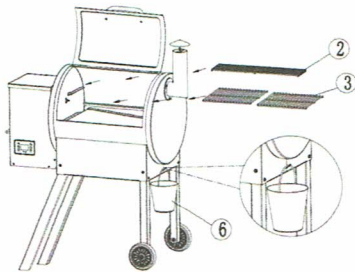

2. Clean the ash in the furnace body and the fire pot, and clean the oil in the oil sump with water, When cleaning, the grease bucket needs to be hung at the oil leakage pipe.

MAUNAL OF MODELS NB-BQ15, NB-BQ16, NB-BQ7 AND NB-BQ9 ENG (5 OF 22)

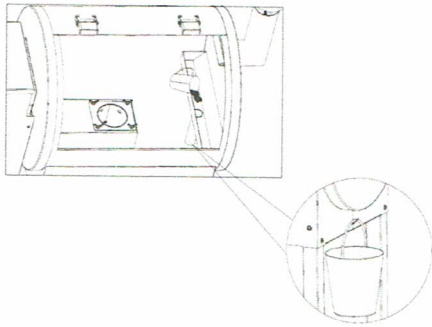

First use instructions

This appliance is intended to burn 6mm wood pellet, the length is less than 20mm only. The wood pellet are rated for 8500 BTU per LBS with water content max 8% of weight and ash proportion max 2% of the weight.

Using poor quality or prohibited pellet fuel will have a negative effect on the function of your pellet stove and can also lead to the warranty becoming null and void, as well as the product liability connected with this. Observe waste incineration legislation. Burn only pellets that have been tested.

In order to guarantee problem free burning of the wooden pellets, it is necessary to store the fuel as dry as possible and free from impurities

1. Put the power switch in the off(O) position before you plug the power cord.

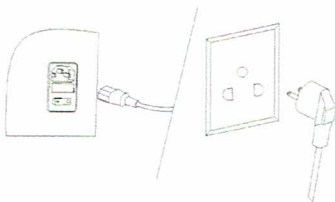

2. Pour the barbecue pellet with a diameter of 6-7 mm and length of 20 mm into the hopper. When pouring, be careful not to drop the pellets in the gap between the hopper and the grill body, If the pellets do fall in the gap, they need to be cleaned up, It is also necessary to add the pellets after start-up, and it is forbidden to remove the pellet in the hopper by hand.

MAUNAL OF MODELS NB-BQ15, NB-BQ16, NB-BQ7 AND NB-BQ9_ENG (6 OF 22)



3. After pouring the barbecue pellets into the hopper, please press the power switch, the indicator now lights up, press the ON-OFF button on the control panel for longer than one second.

Note: If the ignition failed when you first used the grill, the E2 code will appear on the

control panel, you can press **F** longer than one second to clear the error

code, and then press the  to restart.

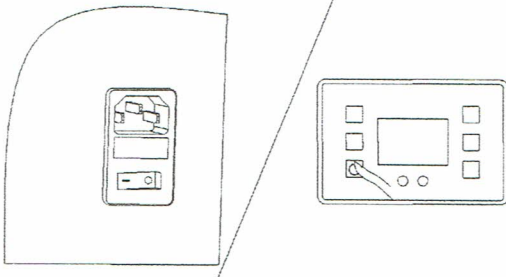

Read all instructions before installing and using the grill

- 1 Open the outer box and take out the product.

MAUNAL OF MODELS NB-BQ15, NB-BQ16, NB-BQ7 AND NB-BQ9 ENG (7 OF 22)

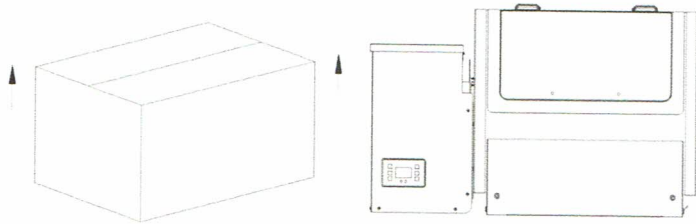

2 Lay the grill flat and take out all the accessories from the body.

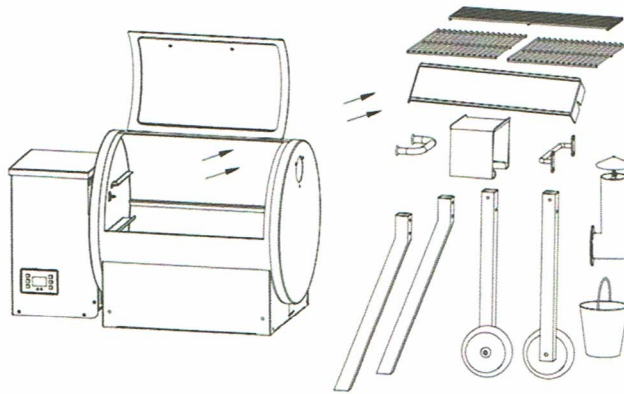

ASSEMBLY INSTRUCTIONS

MAUNAL OF MODELS NB-BQ15, NB-BQ16, NB-BQ7 AND NB-BQ9 ENG (8 OF 22)

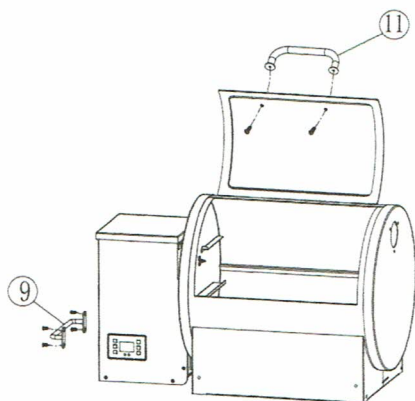

⑨ *1 ⑪ *1 ① *4 ② *2 ③ *2

Step 1. Mounting the handle and carry handle:

- 1) Use the black bolts (D) and washers(E) to install the handle (11) on the grill lid .
- 2) Fix the carry handle (9) to the nut hole on the left side of the hopper storage with the black bolts (B) ,as shown in the diagram above.

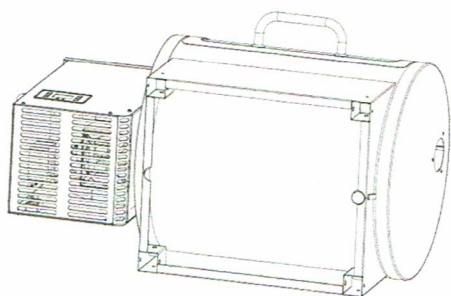

Step 2. This will require two people.

Note: The grill body needs to be laid horizontally.

MAUNAL OF MODELS NB-BQ15, NB-BQ16, NB-BQ7 AND NB-BQ9 ENG (9 OF 22)

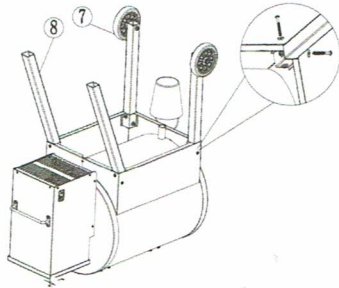

⌋ *2 8 *2 A *8 C *8 E *16

Step 3. Mounting the Wheel legs and Long legs:

Use the black bolts (A);nuts (C) and washers(E) to install the Wheel legs (7) on the right end of the grill and the long legs (8) on the left end of the grill, as shown in the diagram above. (Note:The hole in the leg tube must be aligned with the hole in the furnace body.)

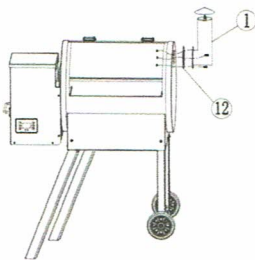

① *1 B *3 C *3 12 *1

Step 4. Mounting the Flue Pipe and Heat Insulation Cotton:

Place the grill upright to level after you have assembled the four legs,now you can start to install the flue pipe,align the hole in the Flue Pipe (1) with the hole in the heat insulation cotton (12), which fits between the right end of the furnace body and the flue pipe (1),From the Hardware Kit, insert three of black bolts (B) and nuts(C) through the holes in the Flue Pipe (1) and the heat insulation cotton (12), align the bolts with the corresponding holes in the furnace body,then adjust the flue pipe vertically,finally tighten each bolt inside the furnace body.

MAUNAL OF MODELS NB-BQ15, NB-BQ16, NB-BQ7 AND NB-BQ9 ENG (10 OF 22)

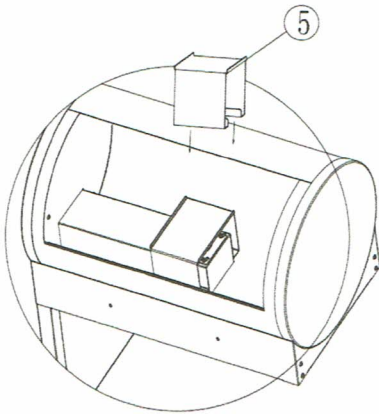

5 *1

Step 5. Mounting the Heat Baffle:

Position the Heat Baffle (5) directly over the Fire pot on the locating brackets found on the inside walls of the grill. The notched legs of the Heat Baffle (5) should be facing downward to fit onto the locating brackets.

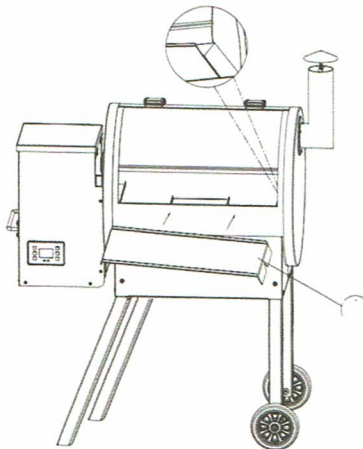

4 *1

Step 6. Mounting the Grease Drip Tray:

1

MAUNAL OF MODELS NB-BQ15, NB-BQ16, NB-BQ7 AND NB-BQ9 ENG (11 OF 22)

Hang the grease drip tray (4) on the support bar in the furnace body as shown in the diagram above. The left side of the grease drip tray is slightly higher than the right side. Be careful not to scratch the inside surface of the furnace body and the probe when placing the grease drip tray.

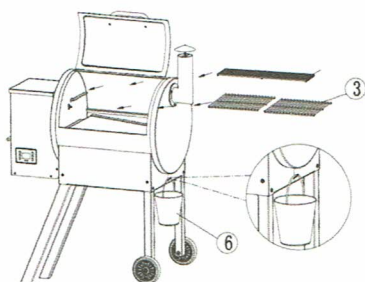

② *1 ③ *2 ⑥ *1

Step 7. Mounting the Warming Rack; Cooking Rack and Grease bucket:

- 1) Position the warming rack (2) on the support bar on the upper side of the furnace body, and then lay it flat in place, when you pull it, it will not fall.
- 2) Position two pieces of square cooking rack (3) side by side on the grilling support bar in the middle of the furnace body, they need to be laid flat.
- 3) Hang the grease bucket (6) on the oil leak hole hook on the lower right side of the furnace body.

Function key description

Getting to know your grill

The grill is equipped with a state-of-the-art electronic controller.

Before you begin using the grill, it will be helpful to familiarize yourself with the different settings and button controls.

MAUNAL OF MODELS NB-BQ15, NB-BQ16, NB-BQ7 AND NB-BQ9_ENG (12 OF 22)

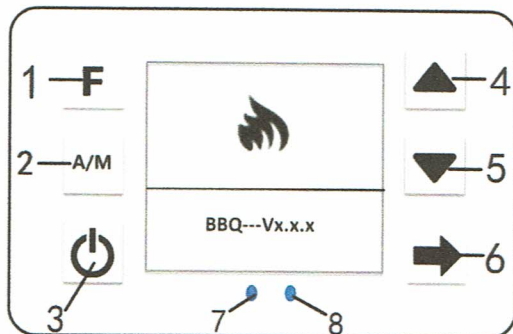

1.Set the interface return button:

In the parameter setting interface state, press the button (less than 1 second) to quit the parameter settings and return to the main interface.

2.AUTO/Manual mode selection

1.In standby mode,Press longer than 1 second,feeding operation,release,feeding stop.

A/M

2.When the cursor stays at the , press the key less than 1 second to select the Auto or Manual operation mode.

3.In the parameter setting interface, press the button less than 1 second to confirm the parameter and enter the parameter setting interface on the next page.

3.ON-OFF button

Press longer than 1 second:switch on/off.

Press less than 1 second:you can check the hopper box protection temperature(start with "P").

4.Data plus button

Press longer than 1 second:the data will continuously increase.

Press less than 1 second:the data will increase one by one.



5. Data minus button

Press longer than 1 second:the data will continuously decrease.

Press less than 1 second:the data will decrease one by one.

6.Moving cursor

MAUNAL OF MODELS NB-BQ15, NB-BQ16, NB-BQ7 AND NB-BQ9 ENG (13 OF 22)

In main interface,when the cursor is on ,Press longer than 1 second to enter the manual mode parameter setting,when the cursor is on , press longer than 1 second to enter the system parameter settings,by pressing (less than 1 second) to moving the cursor.

7.Power light

Light is on, its running; otherwise no power supply or standby.

8.Wireless light

Fast Flashing: ready for matching the network

On: Matching the net work

Off : Either working, or not connected at all

How to set details

Setup - Quick reference guide

MAUNAL OF MODELS NB-BQ15, NB-BQ16, NB-BQ7 AND NB-BQ9 ENG (14 OF 22)

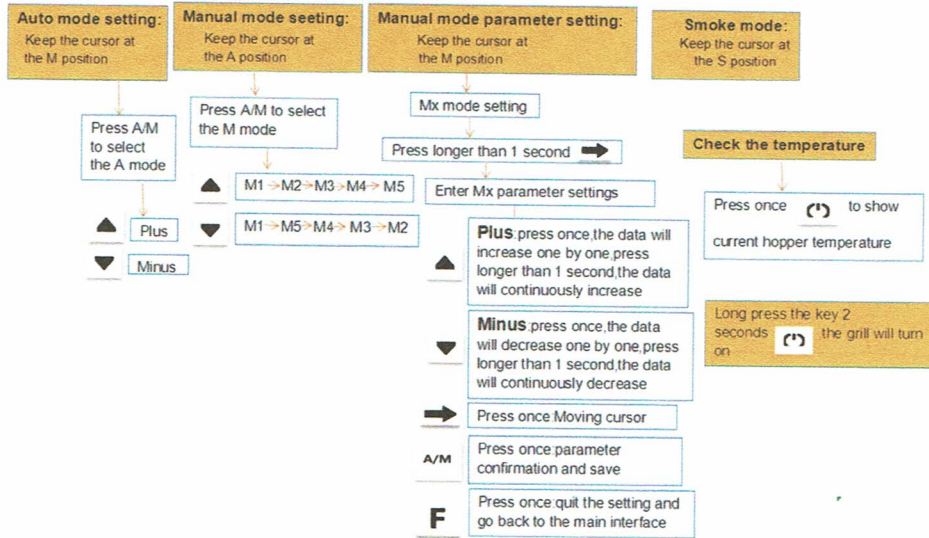

Operation instruction

WARNING! DO NOT OVERFIRE. OVERFIRING THE APPLIANCE MAY CAUSE A FIRE. IF THE UNIT OR CHIMNEY CONNECTOR GLOWS, YOU ARE OVERFIRING.

WARNING! DO NOT USE ACCESSORIES NOT SPECIFIED FOR USE WITH THIS APPLIANCE. WHEN THE APPLIANCE HAS BEEN INVESTIGATED AND DETERMINED TO BE ACCEPTABLE FOR USE WITH A SPECIFIED ACCESSORY, THE STATEMENT SHALL BE MODIFIED AS APPROPRIATE.

一： 1.The new grill is used for the first time,because there are no barbecue pellets in the feeding tube,In the standby state,you can press longer than 1 second and hold

A/M

for fast feeding until there are barbecue pellets in the fire pot.(Note: this operation is not necessary for subsequent use.)

2.The new grill is used for the first time,When the temperature in the furnace reaches above 400 ° F, there will be a small amount of smoke and odor on the outside of the grill. This is a normal phenomenon.

二： Starting up

MAUNAL OF MODELS NB-BQ15, NB-BQ16, NB-BQ7 AND NB-BQ9 ENG (15 OF 22)



1.Keep pressing  to enter the cleaning mode,as shown in picture 1. after 20 seconds, the display will automatically enter the ignition mode,as shown in picture 2.

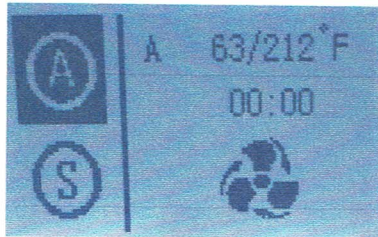

Picture 1

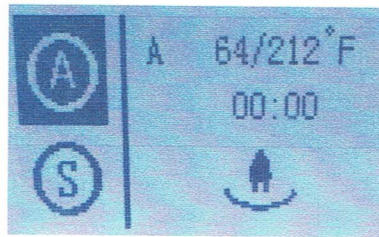



Picture 2





2.According to customer requirements to select the  mode,(**Note:**our factory setting default to AUTO mode.)

AUTO mode: when the cursor stays at the  position,press the key  to

select the AUTO mode,as shown in picture 2,press   to select the desired temperature,in this mode,the set temperature in the furnace will not be saved after the power of the pellet grill is shut off ,it is always default values every time you turn it on. Under the AUTO state , the running time can only be viewed, but cannot be set.The display time is the cumulative running time,indicating the running time after the first stable entry.

Manual Mode: when the cursor stays at the  position,press the key  to select the Manual mode,as shown in picture 3.

MAUNAL OF MODELS NB-BQ15, NB-BQ16, NB-BQ7 AND NB-BQ9 ENG (16 OF 22)

By pressing   can choose M1~M5 modes. Represents step S1 in M1 mode, The temperature indicates the temperature of the furnace set in the current step, and the time is the countdown time, Which indicates the remaining running time in the current step.



Picture 3

When the cursor is in Manual mode, keep pressing  to enter the operating parameter setting of M1, S1~S4 are 4 step parameters in M1 mode, each parameter corresponds to the chamber temperature and running time, users can set according to

their needs. as shown in picture 4.  : Data plus;  : data minus;  :

 shift;  : confirm and save the data;  : exit setting and go back to the main interface.

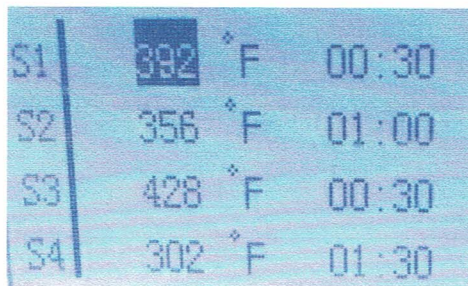

Picture 4

4. Enter smoke mode operation: Press the button , when the cursor

MAUNAL OF MODELS NB-BQ15, NB-BQ16, NB-BQ7 AND NB-BQ9 ENG (17 OF 22)

stays at the **S** position, after 5 seconds, the display will automatically enter the smoke mode, as shown in picture 5. In this mode, the running time can only be viewed, but cannot be set, the display time is the cumulative running time, indicates smoke mode running time. during the operation of the grill, when you need to exit smoke

mode, by press the key  to move the cursor to select A mode, after waiting for 5S, the system will automatically exit smoke mode and enter barbecue mode.

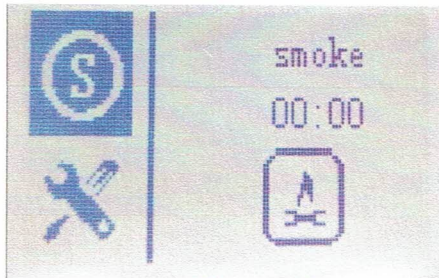

Picture 5

5. AUTO mode / Manual Mode **Lighting state:** as shown in picture 6. (**Note:** when you see the smoke, it will prove that the grill is already working.)

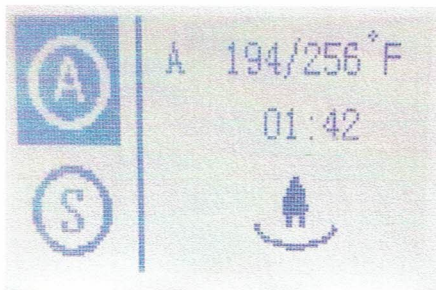

Picture 6

6. AUTO mode / Manual Mode **Burning state:** as shown in picture 7.

MAUNAL OF MODELS NB-BQ15, NB-BQ16, NB-BQ7 AND NB-BQ9 ENG (18 OF 22)



Picture 7

7. AUTO mode / Manual Mode **Stable state**: When the chamber temperature reaches the temperature setting range, it will enter into stable state, as shown in picture10, and starts timing. If the chamber temperature drops below the set temperature range, it enters the ignition state, as shown in picture

8. When the chamber temperature rises to the upper limit of the set temperature range, it enters a cooling state.

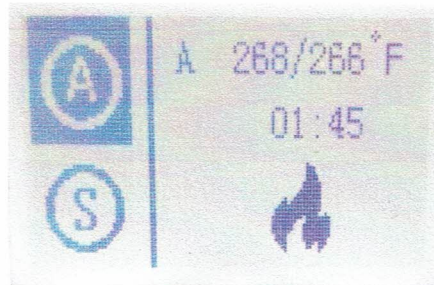

Picture 8

8. AUTO mode / Manual Mode **Cooling state**: When the chamber temperature > (set temperature+temperature difference) , it enters a cooling state, as shown in picture 9.

MAUNAL OF MODELS NB-BQ15, NB-BQ16, NB-BQ7 AND NB-BQ9 ENG (19 OF 22)



Picture 9

9.Switch off state: 1.Keep pressing the button 2 seconds ,the interface is shown in picture 10,feeding stops at this time, but the fan still needs to run for 20 minutes for cooling in the furnace. (**Note:** Do not cut off the power during shutdown)

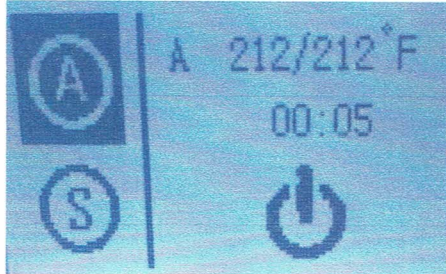

Picture 10

2.After the grill has cooled for 20 minutes.the fan stops and the grill enters the standby state,as shown in picture 11.

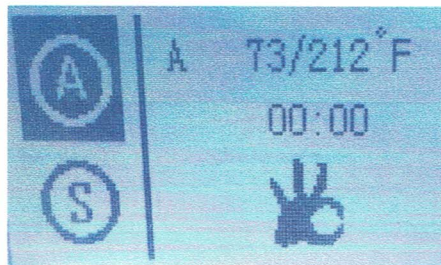

Picture 11

3.After the grill is completely stopped,you can press the red button on the back of the power switch to cut off the power and show it down completely,as shown in picture 12.

MAUNAL OF MODELS NB-BQ15, NB-BQ16, NB-BQ7 AND NB-BQ9 ENG (20 OF 22)

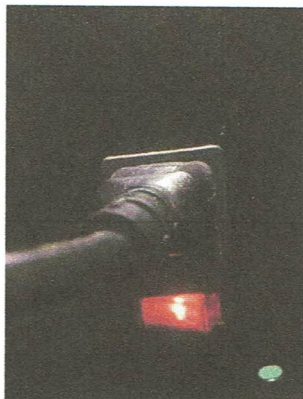

Picture 12

F
E2:Ignition failure. Press **F** longer than 1 second to clear the error code.

F
E6:Hopper temperature is too high, shut off automatic. Press **F** longer than 1 second to clear the error code.

Error code	Description	remark
ESC1	chamber Temperature sensor short circuit	After solving the problem shooting, it can be restarted
ESO1	chamber Temperature sensor open circuit	
ESC2	safety Temperature sensor short circuit	
ESO2	safety Temperature sensor open circuit	
E22	motherboard problem	

list 1

OPERATING TIPS

- 1.The Temperature can be changed at any time to increase or decrease the cooking temperature of the Grill.
- 2.**WARNING!** Your Pellet Grill should never be moved while it is hot. If you are transporting your Grill in a vehicle after cooking on it, make sure the fire is completely out and the grill is cold before placing it in any vehicle. Never put water into the Fire pot. It will jam the Auger.
- 3.Your Pellet Grill is designed to operate with the door closed. Cooking with the door open greatly lengthens your cooking time.

MAUNAL OF MODELS NB-BQ15, NB-BQ16, NB-BQ7 AND NB-BQ9 ENG (21 OF 22)

4. DANGER! Never add pellets by hand to a hot Fire pot. This is dangerous and you may be seriously burned. If you run out of pellets and lose your fire while cooking, let the grill completely cool and start again.

5. CAUTION! Make sure the heat baffle is properly seated on its locating brackets. The long lips of the Heat Baffle should be pointing down over the Fire pot. If not seated properly, direct heat and flame could come up out of the Fire pot and cause a grease fire in the Grill.

6. WARNING! If the fire in the Fire pot goes out while smoking and there are sufficient pellets still in the pellet hopper, it is important to follow these steps. Failure to do so may cause a hazardous "over-firing" of your grill due to an excess of unburned pellets in the Fire pot.

DANGER! Turn the Switch OFF (o) and disconnect the Power Cord. Allow the Grill to thoroughly cool if it is still hot. Open the Door and remove all food, the cooking grate, grease drip tray and the heat baffle.

WARNING! Remove all unburned pellets and ash from inside and around the Fire pot. Before replacing the Heat Baffle, grease drip tray and the cooking grate, plug the Power Cord into an appropriate grounded electrical outlet and turn the Switch ON. When flames start to come out of the fire pot, turn the Switch OFF, let the grill cool down. Now you're ready to place the heat baffle, grease drip tray and cooking grate into the grill.

7. CARBON MONOXIDE

WARNING! Follow these guidelines to prevent this colorless, odorless gas from poisoning you, your family or others.

- Know the symptoms of carbon monoxide poisoning: headache, dizziness, weakness, nausea, vomiting, sleepiness and confusion. Carbon monoxide reduces the blood's ability to carry oxygen. Low blood oxygen levels can result in loss of consciousness and death.
- See a doctor if you or others develop cold or flu-like symptoms while cooking or in the vicinity of this Grill. Carbon monoxide poisoning, which can easily be mistaken for a cold or flu, is often detected too late.
- Alcohol consumption and drug use increase the effects of carbon monoxide poisoning.

Carbon monoxide is especially toxic to mother and child during pregnancy, infants, the elderly, smokers and people with blood or circulatory problems, such as anemia or heart disease.

8. CAUTION! Grease fires are caused by not properly maintaining the grill and failing to clean your grease drip tray. (See maintaining your grill). In the unlikely event of a grease fire while cooking, turn the Switch OFF and Keep the Door closed until the fire is completely out. Never keep the Door open during a grease fire. If it does not go out, lightly sprinkle baking soda on the fire. **CAUTION!** Be careful not to burn yourself. If this does not work then carefully remove the food

MAUNAL OF MODELS NB-BQ15, NB-BQ16, NB-BQ7 AND NB-BQ9 ENG (22 OF 22)

from the Grill and keep the Door closed until the fire is completely out.

CAUTION! Be careful not to burn yourself. If this does not work, carefully remove the food from the grill and keep the door closed until the fire is completely out. Again, be careful not to burn yourself. when the grill is completely cool, remove all internal components, clean any grease accumulation, Replace the grease drip tray and cooking grate, restart the grill and resume cooking.

CAUTION! Never use gasoline, gasoline-type lantern fuel, kerosene, charcoal lighter fluid, or similar liquids to start or 'freshen up' a fire in this appliance. Keep all such liquids well away from the appliance when in use.

CAUTION! USE ONLY WOOD PELELT FUEL SPECIFIED BY THE MANUFACTURER . DO NOT USE PELLET FUEL LABELED AS HAVING ADDITIVES

"Disposal of Ashes" - Ashes should be placed in a metal container with a tight fitting lid. The closed container of ashes should be placed on a noncombustible floor or on the ground, well away from all combustible materials, pending final disposal. If the ashes are disposed of by burial in soil or otherwise locally dispersed, they should be retained in the closed container until all cinders have thoroughly cooled."

Ningbo Hanks Heating Appliance Technology Co.,Ltd

Address: No.5 Xier Road ,Huangjianshan Industry Park ,Lizhou Street ,Yuyao City ,Zhejiang Province ,China .

Tel: 86-574-62510638 Fax : 86-574-62511112