



# U Match

## FLOOR/CEILING INSTALLATION MANUAL

---

*Models:*

***Indoor Unit***

*UMAT18HP230V1AF*

*UMAT24HP230V1AF*

*UMAT30HP230V1AF*

*UMAT36HP230V1AF*

*UMAT42HP230V1AF*

*UMAT48HP230V1AF*

***Outdoor Unit***

*UMAT18HP230V1AO*

*UMAT24HP230V1AO*

*UMAT30HP230V1AO*

*UMAT36HP230V1AO*

*UMAT42HP230V1AO*

*UMAT48HP230V1AO*



# **Thank you for choosing a U-Match Universal Floor/Ceiling Unit for your customer.**

*Please read this installation manual carefully before installing and starting up the Universal Floor/Ceiling Ductless System. Take a moment to fill out the product and installation form on the back cover. Retain both the manual and installation record for future reference.*

## **Table of Contents**

<i>Safety Precautions</i> .....	2
<i>Nomenclature</i> .....	3
<i>System Requirements</i> .....	4
<i>Suggested Tools</i> .....	5
<i>System Schematic</i> .....	6
<i>Standard Parts</i> .....	7
<i>Installation Site Instructions</i> .....	8-9
<i>Indoor Unit Installation</i> .....	10-12
<i>Outdoor Unit Installation</i> .....	13-14
<i>Piping Installation</i> .....	15-18
<i>Power and Wiring Installation</i> .....	18-20
<i>Testing and Inspection</i> .....	21-24
<i>Troubleshooting</i> .....	25-26
<i>Diagnostic Codes</i> .....	27-29

# SAFETY PRECAUTIONS

**Please read the following before installation.**



*This is the safety alert symbol. It is used to alert you to potential personal injury hazards. Obey all safety messages that follow this symbol to avoid possible injury or death.*

**⚠ WARNING**

*This mark indicates procedures which, if improperly performed, might lead to the death or serious injury of the user.*

**⚠ CAUTION**

*This mark indicates procedures which, if improperly performed, might possibly result in personal harm to the user, or damage to property.*

**NOTICE**

*Notice is used to address practices not related to personal injury.*

## General Safety Precautions

1. Instructions for installation and use of this product are provided by the manufacturer. For proper operation, the system must be installed in accordance with this installation manual.
2. Installation must be performed in accordance with local laws, regulations and National Electrical Codes (NEC).
3. If refrigerant leaks while work is being carried out, ventilate the area. Do not allow refrigerant to come in contact with a flame as it produces toxic gas.
4. Disconnect all electrical power to the indoor and outdoor units until the system is ready for start-up and checkout.
5. When installing or repairing the system, use only R410A refrigerant. Do not mix refrigerant with other gases. If air or other gas enter the refrigeration system, the pressure inside the system may rise to an abnormally high value and cause damage or injury.

**⚠ WARNING**

*This appliance is not intended for use by persons (including children) with reduced physical, sensory or mental capabilities, or lack of experience and knowledge, unless they have been given supervision or instruction concerning use of the appliance by a person responsible for their safety.*

# NOMENCLATURE

## Indoor Unit

Example: UMAT18HP230V1AF

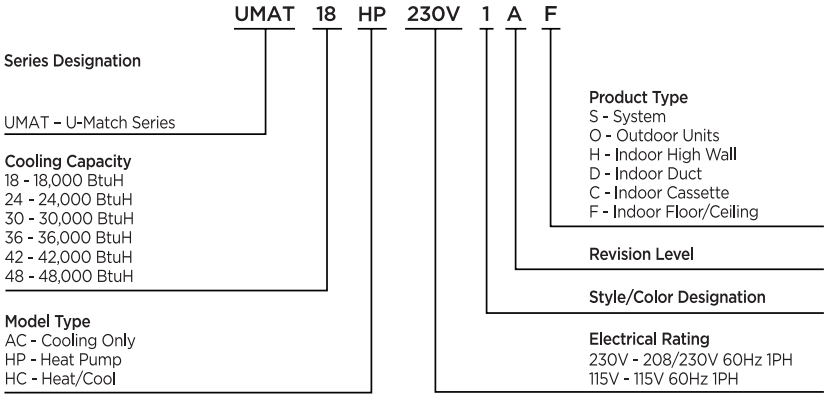

## Outdoor Unit

Example: UMAT18HP230V1AO

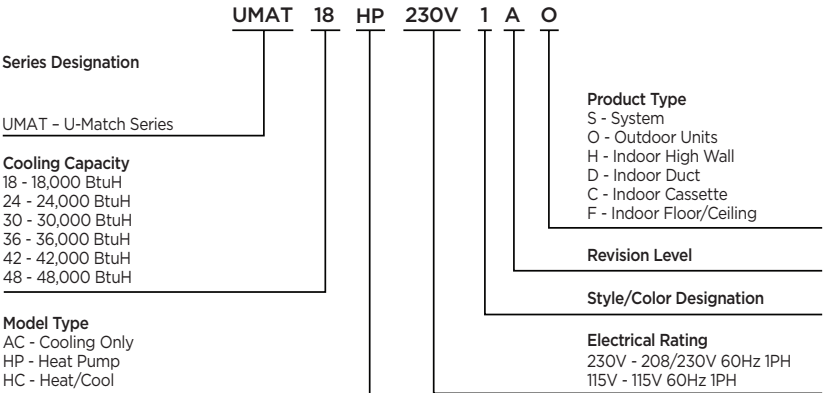

# SYSTEM REQUIREMENTS

## PIPE SIZE in (mm)

## REFRIGERANT LINE LENGTHS ft (m)

Unit Size (BtuH)	Liquid Line	Suction/Gas Line	Min Line Length	Max. Pre-Charge Line Length	Max Line Length	Max Elevation (ID over OD)
18,000	1/4 (6)	1/2 (12)	10 (3)	25(7.5)	164 (50)	49 (15)
24,000	3/8 (10)	5/8 (15)	10 (3)	25(7.5)	164 (50)	49 (15)
30,000	3/8 (10)	5/8 (15)	10 (3)	25(7.5)	164 (50)	49 (15)
36,000	3/8 (10)	5/8 (15)	10 (3)	25(7.5)	164 (50)	49 (15)
42,000	3/8 (10)	5/8 (15)	10 (3)	25(7.5)	164 (50)	49 (15)
48,000	3/8 (10)	5/8 (15)	10 (3)	25(7.5)	230(70)	49 (15)

Notes: Insulate both refrigerant lines, separately.

## REFRIGERANT CHARGE

Unit Size (BtuH)	Refrigerant Type	Factory System Charge oz (kg)*	Additional Charge oz/ft (g/m)
18,000	R410A	49.4 (1.4)	0.3 (30)
24,000	R410A	77.6 (2.2)	0.6 (60)
30,000	R410A	84.6 (2.4)	0.6 (60)
36,000	R410A	123.2 (3.5)	0.6 (60)
42,000	R410A	130.5 (3.7)	0.6 (60)
48,000	R410A	141.8 (4.0)	0.6 (60)

\*Precharge amount for up to 25-ft of refrigerant pipe.

## INDOOR UNIT ELECTRICAL REQUIREMENTS

Unit Size (BtuH)	Voltage	Min Circuit Amps (MCA)	Max Overcurrent Protection (MOCP)	Main Power Wire Size (AWG)
18,000	208/230v - 1ph 60hz	1.0	15	14
24,000	208/230v - 1ph 60hz	1.0	15	14
30,000	208/230v - 1ph 60hz	2.0	15	14
36,000	208/230v - 1ph 60hz	2.0	15	14
42,000	208/230v - 1ph 60hz	2.0	15	14
48,000	208/230v - 1ph 60hz	3.0	15	14

## OUTDOOR UNIT ELECTRICAL REQUIREMENTS

Unit Size (BtuH)	Voltage	Min Circuit Amps (MCA)	Max Overcurrent Protection (MOCP)	Main Power Wire Size (AWG)
18,000	208/230v - 1ph 60hz	17.0	25	10
24,000	208/230v - 1ph 60hz	24.0	40	10
30,000	208/230v - 1ph 60hz	24.0	40	10
36,000	208/230v - 1ph 60hz	29.0	45	8
42,000	208/230v - 1ph 60hz	31.0	50	8
48,000	208/230v - 1ph 60hz	45.0	70	6

Communication Cable: Recommended cable - 18/2 AWG stranded bare copper conductors THHN 300V unshielded wire Note: Use shield cable if installation is in close proximity of RF and EMI transmitting devices.

# SUGGESTED TOOLS

---



- *Standard Wrench*
- *Adjustable/Crescent Wrench*
- *Torque Wrench*
- *Hex Keys or Allen Wrenches*
- *Drill & Drill Bits*
- *Hole Saw*
- *Pipe Cutter*
- *Screw drivers (Phillips & Flat blade)*
- *Manifold and Gauges*
- *Level*
- *R410A Flaring Tool*
- *Clamp on Amp Meter*
- *Vacuum Pump*
- *Safety Glasses*
- *Work Gloves*
- *Refrigerant Scale*
- *Micron Gauge*

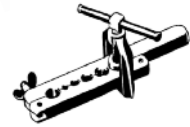

# SYSTEM SCHMATIC

## Indoor Unit

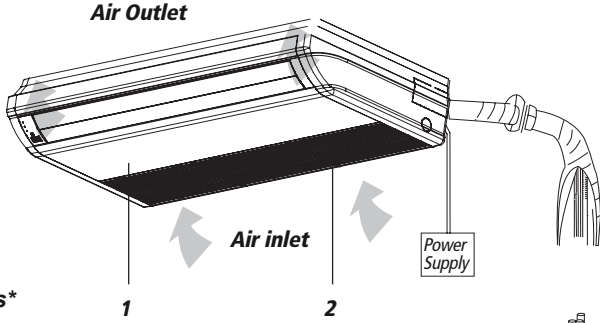

## System Components\*

1. Front Cabinet
2. Air Inlet
3. XK-60 Wired Controller (Optional)
4. Remote Controller
5. Drain Pipe
6. Gas Pipe
7. Liquid Pipe
8. Service Cover
9. Front Panel

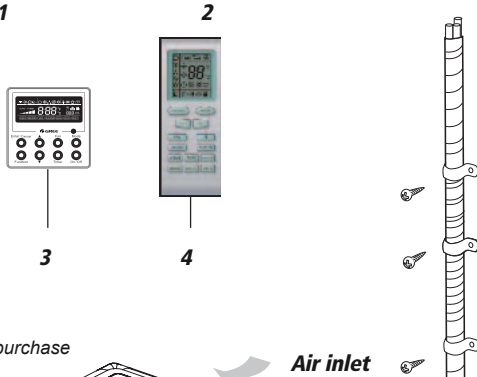

\* Not all items included with equipment purchase

## Outdoor Unit

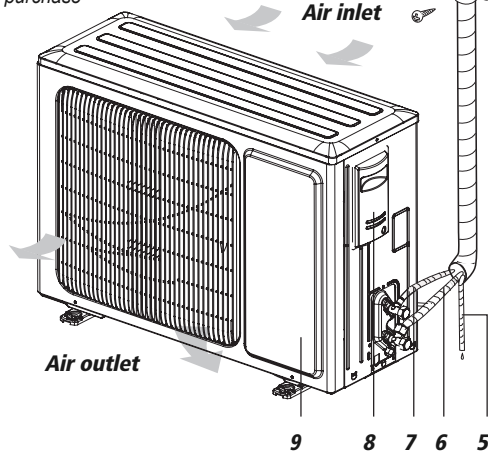









## CAUTION

The refrigerant pipe, drain pipe and electrical wiring for this unit should be installed by a qualified HVAC professional only.

# STANDARD PARTS

## Indoor Unit Accessories\*

\*Not all items included in equipment purchase

No.	Name	Appearance	Qty	Usage
1	Nut with Washer		8	Secures the hook on the cabinet of the unit
2	Remote Controller and Battery		1+2	Controls the indoor unit
3	Cable Clamp		4	Fastens the insulation blanket
4	Pipe Insulation		1	Insulates the gas pipe
5	Pipe Insulation		1	Insulates the liquid pipe
6	Template		2	For drilling holes for mounting indoor unit
7	Flare Nut		1	Connects the gas pipe
8	Flare Nut		1	Connects the liquid pipe

## Outdoor Unit Accessories

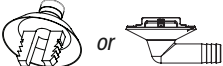
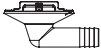
No.	Name	Appearance	Qty	Usage
1	Drain Plug		3	Plugs the unused drain hole
2	Drainage Connector	 or 	1	Connects with field supplied drain pipe



# INSTALLATION SITE INSTRUCTIONS

## Indoor Unit

### **WARNING**

The unit must be installed in a location which can withstand four times the weight of the unit. Inadequate support may result in serious property damage and injuries.

### Select a site that allows for the following:

- Ensure the installation complies with the installation minimum dimensions and meets the minimum and maximum connecting piping length and maximum change in elevation.
- Air inlet and outlet should be clear of obstructions, ensuring proper airflow throughout the room.
- Condensate can be easily and safely drained.
- All connections can be easily made to outdoor unit.
- Indoor unit is out of reach of children.
- A structure strong enough to withstand four (4) times the full weight of the unit.
- Filter can be easily accessed for cleaning.
- Leave enough free space to allow access for routine maintenance.
- Do not install in a laundry room or by a swimming pool due to chemicals corroding indoor unit coil.

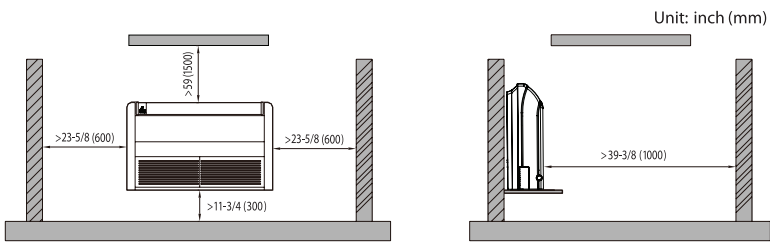

◆ Ceiling type

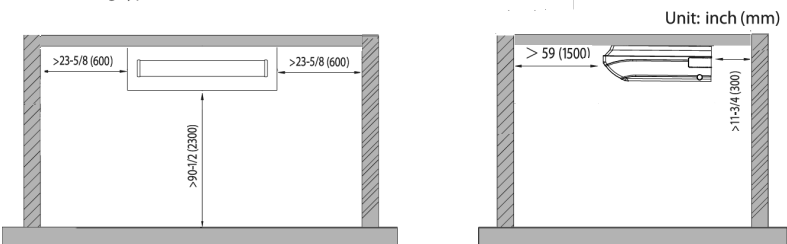

# INSTALLATION SITE INSTRUCTIONS

## Outdoor Unit

Select a site that allows the following:

### **WARNING**

The unit should be installed level on a pad that can support twice the weight of the unit. If the outdoor unit will be exposed to strong winds, it must be adequately secured.

### **CAUTION**

Do not install the unit at a location where the distance exceeds the maximum pipe length indicated in the table. The maximum length of the connection pipe is listed in the System Requirements section.

1. Install the outdoor unit at a location that is capable of withstanding twice the weight of the unit.
2. Install the outdoor unit where it is convenient to connect refrigerant lines to the indoor unit.
3. Install the outdoor unit where the condensate water can be drained unobstructed during the heating mode to a safe location.
4. Do not locate the unit where the noise may be objectionable to neighbors.
5. Provide the space shown below, so that the air flow is not blocked and future service and maintenance can be performed.

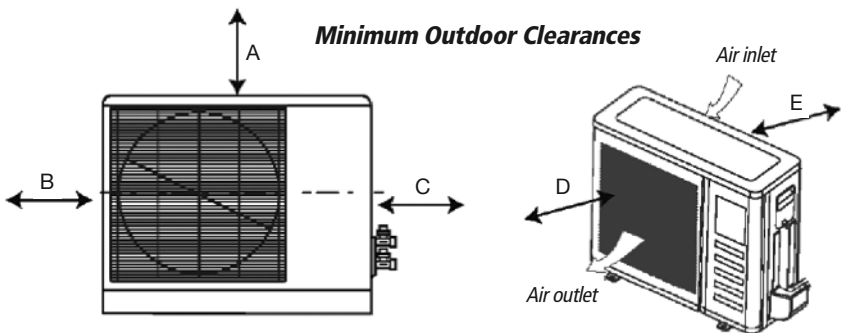

Outdoor Unit	Minimum Distances in (mm)
A	40 (1000)
B	20 (500)
C	20 (500)
D	80 (2000)
E	20 (500)

# INDOOR UNIT INSTALLATION

## Indoor Unit Dimensions

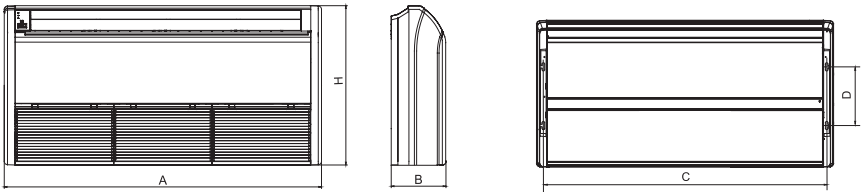

### INDOOR UNIT DIMENSIONS Inches (mm)

Model	A	B	C	D	H	Weight (lbs)
UMAT18HP230V1AF	48	8 7/8	45 5/8	11	27 1/2	86
UMAT24HP230V1AF	(1220)	(225)	(1158)	(280)	(700)	88
UMAT30HP230V1AF	55 7/8	9 5/8	53 1/4	11	27 1/2	106
UMAT36HP230V1AF	(1420)	(245)	(1354)	(280)	(700)	106
UMAT42HP230V1AF						110
UMAT48HP230V1AF	66 7/8	9 5/8	64 3/8	11	27 1/2	130
	(1700)	(245)	(1634)	(280)	(700)	

## Preparing Indoor Unit for Installation

Begin the indoor unit installation by removing the air inlet grille and both side panels from unit as follows:

1. Remove the air inlet grille from the indoor unit to access screws that secure the side panels by unhooking grille latches and removing screws.

Remove the screw

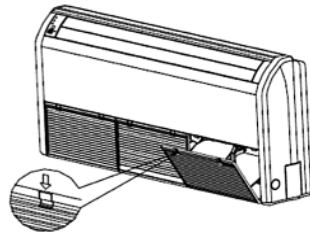
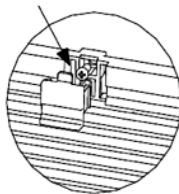

2. Locate and remove the screw securing right side panel. Remove right side panel from indoor unit by sliding it up and off as shown in the figure right.

Remove the screw

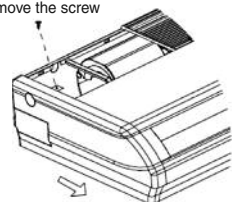

3. Repeat procedure to remove the left side panel

# INDOOR UNIT INSTALLATION

## Laying Out Indoor Location

The Universal Floor/Ceiling units allow for wall or ceiling mounting. Follow the instructions for the desired type of installation.

## Wall Mounting Installation

1. Determine the mounting location on the wall for the indoor unit. Follow the selection criteria in the previous section.
2. Locate the factory supplied installation template included in carton and attach to the wall.
3. Verify the installation template is level right to left and is a minimum 11 3/4 inches above the floor. Mark the 4 mounting holes for the indoor unit. Also mark the condensate drain and refrigeration pipe hole.

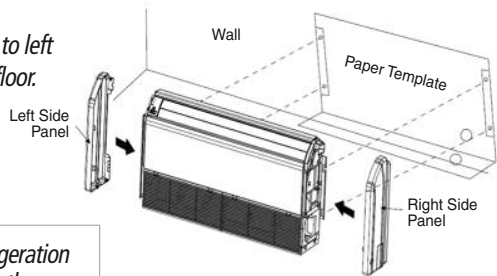
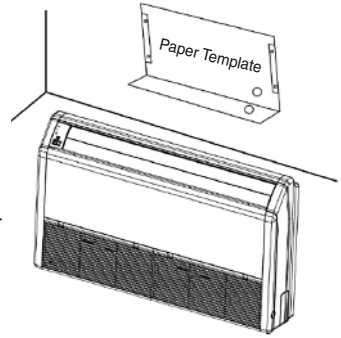

**NOTE:** Depending on the installation, the refrigeration pipes and condensate drain hose may exit from the rear or bottom of the unit.

4. Drill 4 mounting holes and insert anchor bolts (field supplied) into drilled holes.

**NOTE:** It is recommended to install screw anchors for sheet rock, concrete block, brick and such type of walls.

5. Verify indoor unit mounting by carefully lifting unit and setting it on the 4 anchor bolts using the factory provided slots on the side brackets as shown in figure right
6. Carefully remove indoor unit from anchor bolts in order to begin making piping connections.

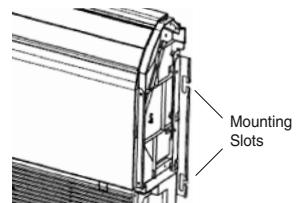

**NOTE:** Do not reinstall air inlet grille or side panels until instructed.

# INDOOR UNIT INSTALLATION

## Ceiling Mounting Installation

1. Determine the mounting location on the ceiling for the indoor unit. Follow the selection criteria in the previous section.
2. Locate the factory supplied installation template included in carton and attach to the ceiling.
3. Mark and drill the 4 mounting holes for the indoor unit.
4. Depending on the type of ceiling, attach the threaded hanger bolts securely to the support stud. Before lifting the indoor unit to the installation location, insert the upper nuts, flat washers (with insulation), flat washers (without insulation), lower nuts and double locking nuts on the threaded hanger bolts.

**NOTE:** The hanger bolts, nuts, and washers are field supplied. Install the washer with cushion so that the insulation faces downward.

5. Verify indoor unit mounting by carefully lifting unit and setting it on the 4 hanger bolts (between the two washers) using the factory provided slots on the side brackets as shown in figures right.
6. Confirm that the indoor unit main body is level horizontally as shown in figure bottom right. Adjust mounting nuts as needed.
7. After checking the positioning of the indoor unit, securely tighten the hanger nuts to fasten the indoor unit in place.

**NOTE:** Do not reinstall air inlet grille or side panels until instructed.

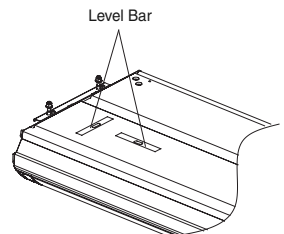
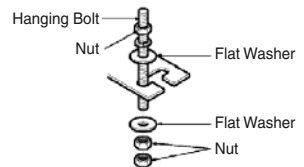
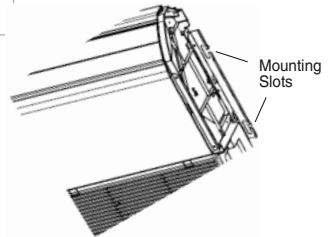
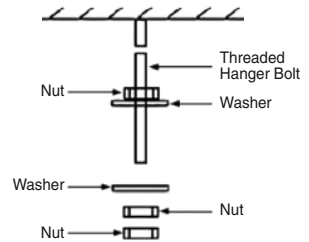
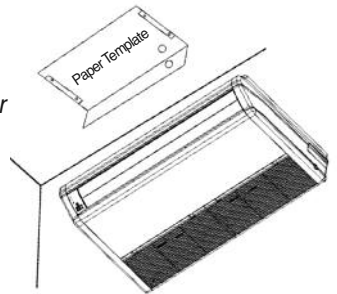

# OUTDOOR UNIT INSTALLATION

## **WARNING**

The unit should be located with the unit support feet firmly on the equipment pad. If the outdoor unit is exposed to wind, it must be properly secured.

### 18K-36K

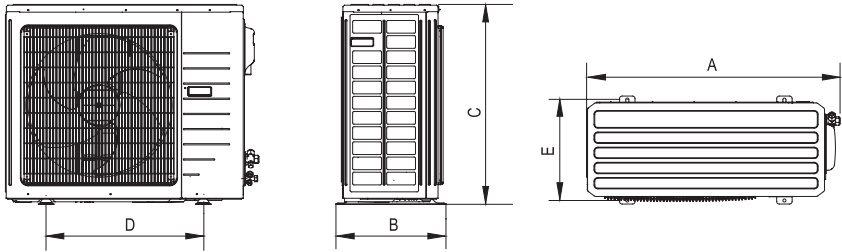

### 42K-48K

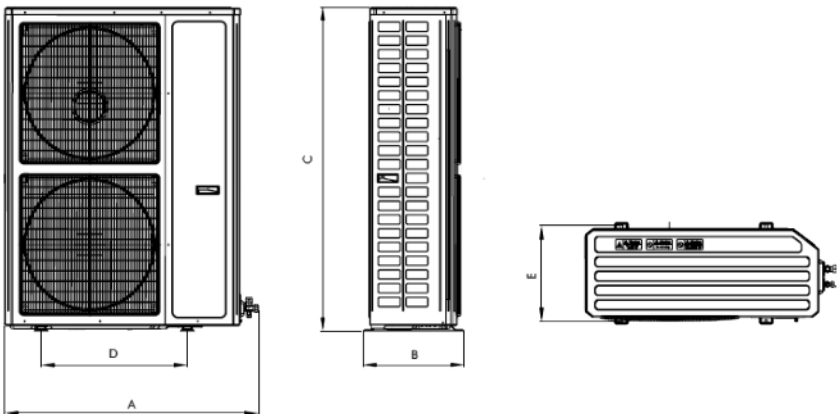

### OUTDOOR UNIT DIMENSIONS in (mm)

Model	A	B	C	D	E
UMAT18HP230V1AO	37-5/8 (955)	15-5/8 (396)	27-1/2 (700)	22 (560)	14-1/8 (360)
UMAT24HP230V1AO UMAT30HP230V1AO	38-5/8 (980)	16-3/4 (427)	31-1/8 (790)	24 (610)	15-1/2 (395)
UMAT36HP230V1AO UMAT42HP230V1AO	43-5/8 (1107)	17-3/8 (440)	43-1/4 (1100)	24-7/8 (631)	15-3/4 (400)
UMAT48HP230V1AO	37-3/4 (958)	16-1/4 (412)	53-1/8 (1349)	22-1/2 (572)	14-3/4 (376)

# OUTDOOR UNIT INSTALLATION

---

## Condensate Drainage of the Outdoor Unit

The outdoor unit should be installed with a drain pipe to drain condensate water during the heating mode.

1. Insert the drain joint (included) into the selected hole located on the bottom of the base pan and then connect the drain hose (field supplied) to the drain joint.
2. All other holes must be sealed with plugs (included) to avoid water leaks, except for the drain pipe mounting hole.
3. Route drain hose to safe location for disposing of condensate water.

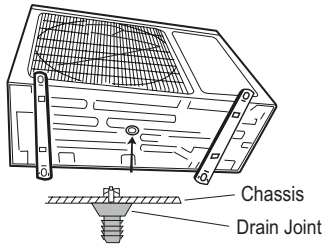
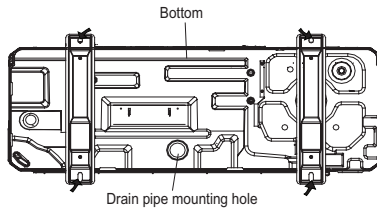

# PIPING INSTALLATION

## Refrigerant Piping

### Drill Hole in Wall

1. Locate and mark proper location for the wall hole.
2. Cut the 2 3/4" wall hole with a 5° to 10° downward slant to the outdoors.
3. Insert a wall sleeve (field supplied) into hole to prevent damage to refrigerant pipes, insulation, condensate drain hose and wiring.
4. Proper weather proofing of the wall surface and wall sleeve is essential to assure a trouble-free installation. Apply sealant, caulking or equivalent weather proofing material around the perimeter of the wall sleeve (interior & exterior) to eliminate outdoor air and water leaks into the indoor space.

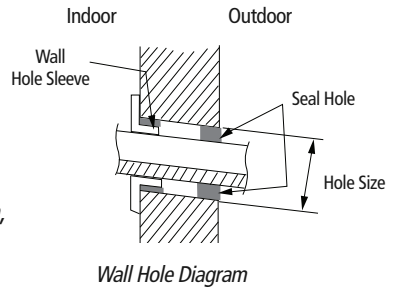

**NOTE:** Expandable foam insulation may be added to fill large wall gaps. Apply per manufacturer's instructions.

### Piping Preparation

1. Do not open service valves or remove protective caps on pipes until instructed by this manual.
2. Keep tubing free of dirt, sand, moisture and contaminants.
3. Insulate each refrigerant pipe and condensate hose with minimum 3/8" (10 mm) wall thermal pipe insulation.

## CAUTION

Insulate entire interior section of condensate hose to prevent sweating which may cause water stains or wall damage.

4. Bind refrigerant pipes and communication cable together with cable ties at 12-inch intervals.
5. Include the condensate hose in bundle for exterior portion only.

### Indoor Unit below Outdoor Unit Application

When height difference between indoor unit and outdoor unit is more than 30 feet, an oil return bend should be added for every 20 feet of connection pipe as shown.

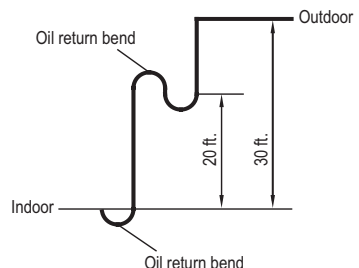



# PIPING INSTALLATION

## Indoor Unit Pipe Connections

1. Feed refrigerant pipes, drain hose and communication cable assembly through wall hole from outdoor to the Floor/Ceiling indoor unit.
2. Pull the piping assembly to the indoor unit. Carefully bend refrigerant pipes to meet indoor unit connection ports. Use proper tools to avoid kinks.
3. Add a small amount of refrigerant oil to both ends of the flare fittings.
4. Starting with either refrigerant pipe, carefully center the pipe to the indoor unit connection port then hand tighten the flare nut.
5. Repeat procedure with remaining pipe.
6. Tighten both flare nuts using a standard wrench and a torque wrench as shown below.

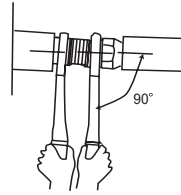
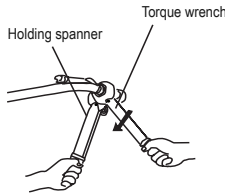
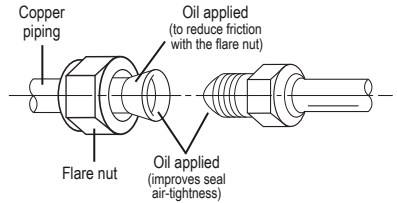

7. Carefully tighten flare nuts to correct torque level referring to the Torque Table below.

Pipe Diameter inch (mm)	Nut Size inch (mm)	Tightening Torque	
		ft-lbs	N-m
1/4 (6)	1/4 (17)	11 to 22	15 to 30
3/8 (9.5)	3/8 (22)	26 to 29	35 to 40
1/2 (12.7)	1/2 (25)	33 to 37	45 to 50
5/8 (16)	5/8 (29)	44 to 48	60 to 65



## CAUTION

Over tightening may damage flare connections and cause leaks.

8. Individually insulate each bare refrigerant pipe and joint as shown below to prevent sweating.

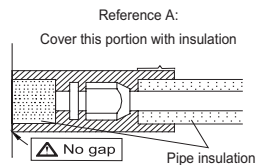
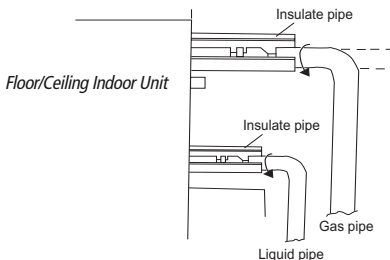

# PIPING INSTALLATION

## Outdoor Unit Pipe Connections

1. Remove service valve cover (if provided) to access the service valves and refrigerant ports.
2. Carefully bend and adjust length of refrigerant pipes to meet outdoor unit service valve connections with proper tools to avoid kinks.
3. Add a small amount of refrigerant oil to both ends of the flare fittings.
4. Starting with either refrigerant pipe, carefully center the pipe to the indoor unit connection port then hand tighten the flare nut.
5. Repeat procedure with remaining pipe.
6. Tighten both flare nuts using a standard wrench and a torque wrench as shown.
7. Carefully tighten flare nuts to correct torque level referring to the Torque Table below.

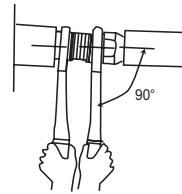
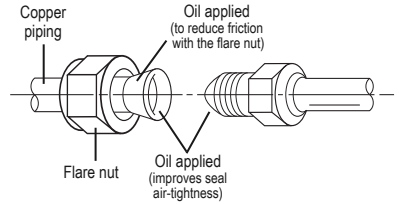
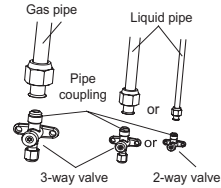
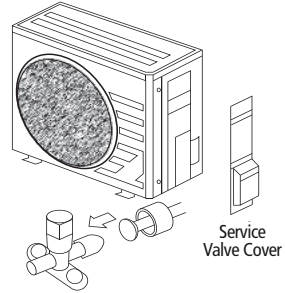

Pipe Diameter inch (mm)	Nut Size inch (mm)	Tightening Torque	
		ft-lbs	N-m
1/4 (6)	1/4 (17)	11 to 22	15 to 30
3/8 (9.5)	3/8 (22)	26 to 29	35 to 40
1/2 (12.7)	1/2 (25)	33 to 37	45 to 50
5/8 (16)	5/8 (29)	44 to 48	60 to 65

### CAUTION

Over tightening may damage flare connections and cause leaks.

# PIPING INSTALLATION

## Indoor Condensate Drain Piping

### **WARNING**

Observe all local sanitary codes when installing condensate drains.

The drain piping should be as short as possible with a constant downward slope. It is recommended to install the condensate drain system with hard polyvinyl chloride (PVC) pipe and matching connectors. Use piping of the same or greater diameter as the unit connection.

The Floor/Ceiling drainage port diameter is 11/16-in (17-mm) OD.

Pitch the condensate drain pipe at a gradual 2.5% pitch (Example: ¼-in drop over a 10-in length) without obstructions. Use pipe hanger/brackets to support the condensate drain pipe from dropping.

### Typical Drainage System

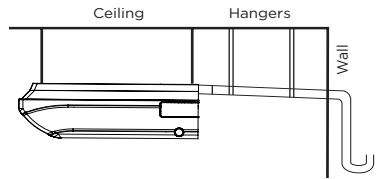

**NOTE:** Insulate condensate hose and/or pipes to prevent sweating which may cause water stains or wall damage.

If a gradual pitch from the drainage port is not obtainable, use an auxiliary condensate pump with float valve. A float valve is recommended to shut off the system if auxiliary pump fails.

### Completing Condensate Drainage Piping

- Include the exterior section of condensate hose in the pipe/wire bundle.
- Fasten the refrigerant and condensate pipe assembly to the exterior wall for support.
- The drain pipe should terminate 6 inches above grade.

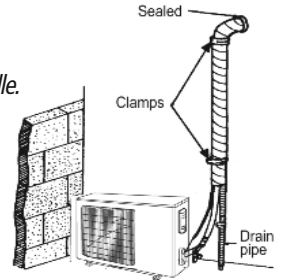

### Test the Condensate Drainage Piping

- Find the drainage port with the air inlet grille and right side panel removed.
- Slowly add 20 to 24 oz. of water to the drain pan as shown below.
- Water must drain freely from the unit. If not, check the pipe slope or see if there are any pipe restrictions.
- Verify all piping joints are leak free.

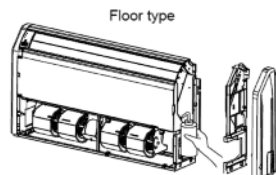
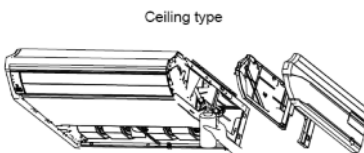

### **WARNING**

- 1. Before obtaining access to terminals, all electrical supply circuits must be disconnected.*
- 2. Always use an independent circuit and provide an independent circuit breaker to supply power to the system.*
- 3. Use a circuit breaker with adequate capacity to meet the requirements.*
- 4. All circuit breakers or fuses for the indoor and outdoor units should be installed per the National Electric Code (NEC) and local regulations.*
- 5. Electrical wiring must be completed in accordance with NEC, local laws, and regulations of the electric company so that the system will operate properly.*
- 6. Provide a GFI circuit breaker at the electrical panel in accordance with the NEC and the local electrical company standards.*
- 7. Connect the power supply firmly to the terminal block. Improper installation may cause a fire.*

### **CAUTION**

- 1. The main power supplies are high-voltage, while the communication wire and the Tether Controller are low-voltage. They should be installed separately to avoid electromagnetic interference.*
- 2. High-voltage and low-voltage lines should pass through separate rubber rings at electric box covers.*
- 3. If the indoor unit communication wire (to the outdoor unit) and power wire are connected incorrectly, the air conditioner may be damaged.*
- 4. Ground both indoor unit and outdoor unit to earth ground in accordance with the applicable local and national codes.*

# POWER AND WIRING INSTALLATION

## Electric Wiring between the Indoor and Outdoor Units

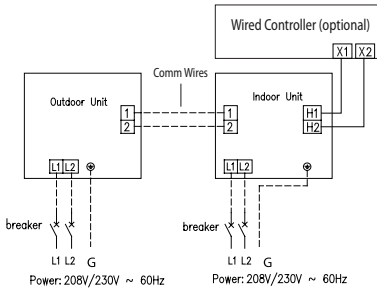

Single-phase units (18K-30K)

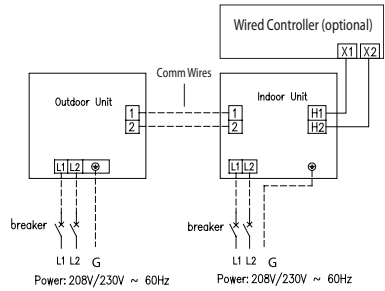

Single-phase units (36K-48K)

## Indoor Unit Electrical Wiring

Remove the left side panel and the electric box cover, and then insert the communication wire and power wire into the terminal board.

## Indoor Communication Wiring

The recommended communication cable size is a minimum 18/2 AWG stranded bare copper conductors THHN 300V unshielded wire. Use shielded cable if installation is in close proximity of RF and EMI transmitting devices. Locate wire terminals #1 and #2. Connect communication cable from outdoor unit to terminals #1 and #2. Secure cable inside wire clamp/strain relief. Verify cable is secure, not loose and no external force on wires affects the connections at the terminals.

**NOTE:** Record wire colors and terminal references for use with Outdoor Unit wire connections.

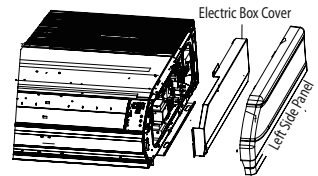

## Indoor Unit Power Wiring

Locate wire terminals L1 and L2. Connect main electrical power outdoor unit to terminals L1 and L2. Connect ground wire to grounding screw. Secure electrical wires inside wire clamp/strain relief. Verify wires are secure, not loose and no external force on wires affects the connections at the terminals.

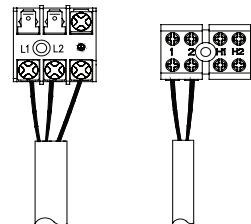

Power Supply Wire

Communication Wire

# POWER AND WIRING INSTALLATION

## Tether Controller Wiring (Optional)

Use a minimum 18-2 AWG wire (field supplied) to connect Tether Controller to the indoor unit. Route wire from Tether Controller into electrical box. Locate wire terminals H1 and H2. Connect Tether Controller wires to H1 and H2. Verify wires are secure, not loose and no external force on wires affects the connections at the terminals. Follow instructions provided with Tether Controller to complete the installation.

## Complete Indoor Installation

Replace the electrical box cover, both right and left side panels and inlet air grille.

## Outdoor Unit Electrical Wiring

Remove the large handle access plate on the 18K to 30K size or the front panel for the 36K to 48K size to access wire terminals.

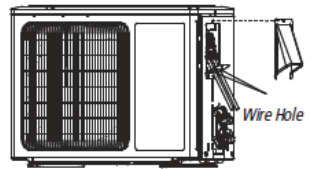

## Outdoor Communication Wiring

Connect communication cable from indoor unit to terminals #1 and #2. Maintain the same wire colors and terminal references as indoor unit wire connections.

**NOTE:** Crossing communication wires will cause an E6 system malfunction code and possible damage.

Secure cable inside wire clamp/strain relief. Verify cable is secure, not loose and no external force on wires affects the connections at the terminals.

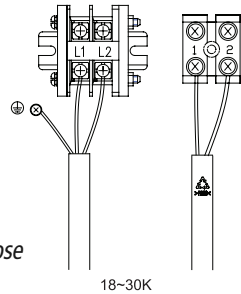

## Outdoor Unit Power Wiring

Insert main power wires through the wire holes on conduit mounting bracket. Secure main electrical power conduit with locking nuts to conduit mounting bracket. Locate wire terminals L1 and L2. Adjust wire lengths for proper connections to the outdoor unit terminal block. Connect main electrical power outdoor unit to terminals L1 and L2. Connect Ground wire to ground terminal/screw. Secure electrical wires inside wire clamp/strain relief. Verify wires are secure, not loose and no external force on wires affects the connections at the terminals. Replace and secure electrical box cover to outdoor unit.

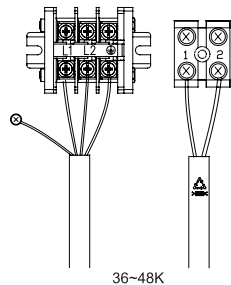

**NOTE:** When connecting the power wire, make sure that the phase of the power supply matches with the exact terminal board. If not, the compressor will rotate reversely and run improperly.

# TESTING AND INSPECTION

## Pipe Testing

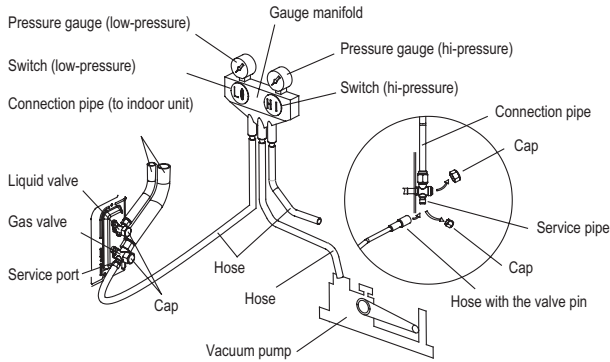

## Leak Test

Refrigerant lines should be pressurized prior to evacuating system to check for leaks. Use only dry nitrogen with a pressure regulator for pressurizing unit. Pressurize with 150 psi of dry nitrogen. Apply soap and water to check whether the joints are leaky. A leak detector may also be used for a leakage test.

**NOTE:** You may want to perform leak testing and evacuation before wiring to save time, electrical connections can be completed while your vacuum pump is running.

## CAUTION

Use vacuum pump, rather than refrigerant, to discharge air when installing the unit.

## Additional Charge

Refrigerant for the pipe length of 25 feet has been charged at the factory. If the piping is greater than 25 feet additional charging is necessary. For the additional amount, see the table below.

Model	Add'l Refrigerant (oz/ft (g/m))
18,000	0.3 (30)
24,000	0.6 (60)
30,000	0.6 (60)
36,000	0.6 (60)
42,000	0.6 (60)
48,000	0.6 (60)

# TESTING AND INSPECTION

## Vacuum Procedure

**Important:** Use a quality Micron Gauge to measure and validate the proper system vacuum level achieved. Do not rely on the scale of a "bourbon tube" type gauge set to validate the depth and quality of the vacuum.

1. Remove the caps of the liquid valve, gas valve and service port.
2. Connect gauge manifold and micron gauge to the service ports provided at the liquid and suction service valves.
3. Connect a vacuum pump to the manifold gauge.
4. Open the lower pressure side of the manifold valve assembly and start the vacuum pump. The switch at the high pressure side of the manifold valve assembly should be kept closed, or evacuation does not fail.
5. Operate vacuum pump until a vacuum of 500 microns or less is achieved. The evacuation duration depends on the vacuum pump size and unit's capacity, generally 20 minutes for the 9,000 BtuH units, to 1 hour for a larger 36,000 BtuH unit.
6. Close the manifold valves and shut off the pump.
  - a. If vacuum holds below 700 microns for 15 minutes, the system can be considered dry and leak free. Go to step 5.
  - b. If vacuum increases to 800 microns or greater, this is an indication of moisture in system or a leak exists. Identify leak and repair as necessary, after which repeat steps 4 and 5. If moisture is suspect, purge system use triple evacuation method using dry nitrogen.
7. Confirm that manifold valves are closed and disconnect the vacuum pump.
8. Open the service valves to the fully 'back-seat' position to let the refrigerant flow to the indoor unit and balance the pressure in system.

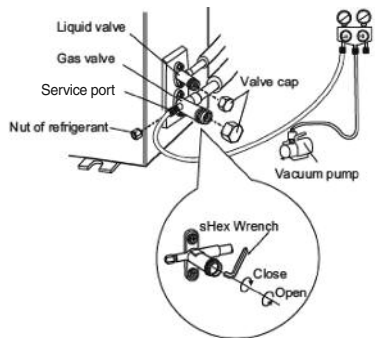

**Note:** Do not allow air to enter the connection pipe when removing the hose.

9. Replace service valve caps and tighten.



# TESTING AND INSPECTION

## Overview of Display Panel

1. **Power Indicator:** Power indicator will be on after electrical power is turned on, while it will be off after disconnecting power.
2. **COOL Indicator:** COOL indicator will be on after COOL mode is activated while it will be off after COOL mode is turned off.
3. **Heat Indicator:** HEAT indicator will be on after HEAT mode is activated, while it will be off after HEAT mode is turned off.
4. **Indoor setpoint and temperature display.**

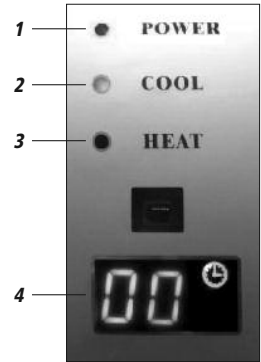

## Start-up Checklist

**Turn on main power to indoor and outdoor units.**

- Verify the system is not displaying an error code on the indoor unit display.

**Point the Remote Controller at the Floor/Ceiling unit and Press the On button.**

- Verify the remote controller display turns ON and the Power Indicator lights up on the Floor/Ceiling unit.

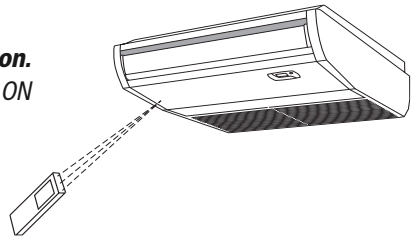

**Press the Mode button to Cooling.**

Adjust the room setpoint to bring the system on in cooling mode. The system should start cooling mode within 3-5 minutes.

- Verify the setpoint lights up on the Floor/Ceiling unit display.
- Verify the outdoor fan and compressor are operating.
- Verify the indoor fan is operating.
- Verify the indoor discharge air is cooling the room.

**Press the Mode button to Heating.**

Adjust the room setpoint to bring the system on in heating mode. The system should start heating mode within 3-5 minutes.

- Verify the new setpoint lights up on the Floor/Ceiling unit display.
- Verify the outdoor fan and compressor are operating.
- Verify the indoor fan is operating.
- Verify the indoor discharge air is heating the room.

**Press the OFF button on the Remote Controller.**

- Verify Remote Controller display turns OFF and the system shuts OFF.

# TROUBLESHOOTING

PROBLEM	CAUSE/SOLUTION
System does not restart.	<p><b>Cause:</b> The system has a built-in three-minute delay to prevent short and/or rapid cycling of the compressor.</p> <p><b>Solution:</b> Wait three minutes for the protection delay to expire.</p>
Indoor unit emits unpleasant odor when started	<p><b>Cause:</b> Typically unpleasant odors are the result of mold or mildew forming on the coil surfaces or the air filter.</p> <p><b>Solution:</b> Wash indoor air filter in warm water with mild cleaner. If odors persist, contact a qualified service professional to clean the coil surfaces.</p>
You hear a "water flowing" sound.	<p><b>Cause:</b> It is normal for the system to make "water flowing" or "gurgling" sounds from refrigerant pressures equalizing when the compressor starts and stops</p> <p><b>Solution:</b> The noises should discontinue as the refrigerant system equalizes after two or three minutes.</p>
A thin fog or vapor coming out of the discharge register when system is running.	<p><b>Cause:</b> It is normal for the system to emit a slight fog or water vapor when cooling extremely humid warm air.</p> <p><b>Solution:</b> The fog or water vapor will disappear as the system cools and dehumidifies the room space.</p>
You hear a slight cracking sound when the system stops or starts.	<p><b>Cause:</b> It is normal for the system to make "slight cracking" sounds from parts expanding and contracting during system starts and stops.</p> <p><b>Solution:</b> The noises will discontinue as temperature equalizes after 2 or 3 minutes.</p>
The system will not run.	<p><b>Cause:</b> There are a number of situations that will prevent the system from running.</p> <p><b>Solution:</b> Check for the following:</p> <ul style="list-style-type: none"> <li>• Circuit breaker is "tripped" or "turned off."</li> <li>• Power button of controller is not turned on.</li> <li>• Controller is in sleep mode or timer mode.</li> <li>• Otherwise, contact a qualified service professional for assistance.</li> </ul>
The unit is not heating or cooling adequately.	<p><b>Cause:</b> There are a number of reasons for inadequate cooling or heating.</p> <p><b>Solution:</b> Check the following:</p> <ul style="list-style-type: none"> <li>• Remove obstructions blocking airflow into the room.</li> <li>• Clean dirty or blocked air filter that is restricting airflow into the system.</li> <li>• Seal around door or windows to prevent air infiltration into the room.</li> <li>• Relocate or remove heat sources from the room.</li> </ul>

# TROUBLESHOOTING

<b>PROBLEM</b>	<b>CAUSE/SOLUTION</b>
<i>Water leakage from the outdoor unit.</i>	<p><b>Cause:</b> It is normal for the outdoor unit to generate condensate water in the reverse cycle heating and defrost mode.</p> <p><b>Solution:</b> This is normal. No action is required.</p>
<i>Water leaking from the indoor unit into the room.</i>	<p><b>Cause:</b> While it is normal for the system to generate condensate water in cooling mode, it is designed to drain this water via a condensate drain system to a safe location.</p> <p><b>Solution:</b> If water is leaking into the room, it may indicate one of the following.</p> <ul style="list-style-type: none"><li>• The indoor unit is not level right to left. Level indoor unit.</li><li>• The condensate drain pipe is restricted or plugged. All restrictions must be removed to allow continuous drainage by gravity.</li><li>• If problem persists, contact a qualified service professional for assistance.</li></ul>
<i>The unit will not deliver air.</i>	<p><b>Cause:</b> There are a number of system functions that will prevent air flow.</p> <p><b>Solution:</b> Check for the following:</p> <ul style="list-style-type: none"><li>• In heating mode, the indoor fan may not start for three minutes if the room temperature is very low. This is to prevent blowing cold air.</li><li>• In heat mode, if the outdoor temperature is low and humidity is high, the system may need to defrost for up to 10 minutes before beginning a heating cycle.</li><li>• In dry mode, the indoor fan may stop for up to three minutes during the compressor off delay.</li><li>• Otherwise, you should contact a qualified service professional for assistance.</li></ul>

# DIAGNOSTIC CODES

The U-Match System has on board diagnostics. The indoor unit and Tether Controller will display error codes. The following is a summary of the codes with explanation:

## Error Codes

No.	Error Code	Malfunction Name	Origin of Malfunction	Description
1	E1	High Pressure Protection	High Pressure Switch	If outdoor unit detects the high pressure switch is cut off for 3-sec successively, high pressure protection will occur. All the loads (except the 4-way valve in heating mode) will be switched off. In this case, all the buttons and remote control signals except ON/OFF button will be disabled and system won't be recovered automatically. Switch off the unit or re-energize the unit after cutting off power to eliminate this protection.
2	E2	Indoor Coil Freeze Protection	Indoor Evaporator Temperature Sensor	If indoor unit detects the evaporator temperature is lower than protective temperate value after the unit has been running for a period of time under cooling or dry mode, the unit will report this fault, in which case the compressor and outdoor fan motor will be stopped. The unit will not run until evaporator temperature is higher than the protective temp. value and the compressor is stopped for 3-min.
3	E3	Low Pressure Protection	Low Pressure Switch	If outdoor unit detects low-pressure switch is open during ON or standby state within 30-sec successively the unit will report a low pressure protection. If the fault occurs 3 times successively within 30-min, the unit will not recover automatically.
		Low Refrigerant Protection		If the unit reports low refrigerant level within 10-min after turning on the unit, the unit will stop operation. If the fault occurs successively 3 times, the unit cannot be recovered automatically.
		Refrigerant Recycling Mode		If the unit enters refrigerant recovery mode through special operation, E3 will be displayed. After exiting refrigerant recovery mode, the code will disappear.
4	E4	Compressor High Discharge Temperature Protection	Compressor Discharge Temperature	If outdoor unit detects the discharge temperature is higher than protective temperature value, the unit will report high discharge temperature protection. If the protection occurs over 6 times, the unit cannot be recovered automatically. Switch off the unit or re-energize the unit after cutting off power to reset this protection.
5	E6	Communication Malfunction	Communication Failure Between Indoor and Outdoor Main Board	If the outdoor unit does not receive data from indoor unit, communication malfunction will be reported. If there is communication abnormality between display board and indoor unit, communication malfunction will be reported.
6	E8	Low Indoor Airflow	Indoor Fan Motor	If the indoor unit does not receive signal from indoor fan motor for 30-sec successively when the fan motor is operating, indoor fan motor malfunction will be reported. In this case, the unit can automatically resume operation after stopping. If the malfunction occurs 6 times within one hour, the unit cannot be recovered automatically. Switch off the unit or re-energize the unit after cutting off power to eliminate this malfunction.

# DIAGNOSTIC CODES

## Error Codes

No.	Error Code	Malfunction Name	Origin of Malfunction	Description
7	E9	Condensate Overflow Protection	Overflow Switch	If indoor unit detects the condensate overflow switch warning for 8-sec successively, the system will enter condensate overflow protection. The unit will shut off and will not recover automatically. Switch unit off and then switch it on to eliminate this malfunction.
8	F0	Indoor Ambient Temperature Sensor at Return Air Inlet Malfunction	Indoor Ambient Temperature Sensor	If indoor unit detects the indoor ambient temperature sensor is open circuit or short circuit for 5-sec successively, indoor ambient temp. sensor malfunction will be reported. The unit can automatically resume operation after the malfunction disappears. If indoor ambient temperature sensor malfunction occurs in fan mode, only the error code is displayed and the indoor unit will operate normally.
9	F1	Indoor Evaporator Coil Temperature Sensor Malfunction	Evaporator Coil Temperature Sensor	If indoor unit detects the evaporator temperature sensor is open circuit or short circuit for 5-sec successively, evaporator temperature sensor malfunction will be reported. The unit can automatically resume operation after the malfunction disappears. If evaporator temperature sensor malfunction occurs in fan mode, only the error code is displayed and the indoor unit will operate normally.
10	F2	Indoor Condenser Coil Temperature Sensor Malfunction	Condenser Coil Temperature Sensor	If outdoor unit detects the condenser coil temperature sensor open circuit or short circuit for 5-sec successively, condenser coil temperature sensor malfunction will be reported. The unit can automatically resume operation after the malfunction disappears. If condenser temperature sensor malfunction occurs in fan mode, only the error code is displayed and the indoor unit will operate normally.
11	F3	Outdoor Ambient Temperature Sensor Malfunction	Outdoor Ambient Temperature Sensor	If outdoor unit detects the outdoor ambient temperature sensor open circuit or short circuit for 5-sec successively, outdoor ambient temperature sensor malfunction will be reported. The unit can automatically resume operation after the malfunction disappears. If outdoor ambient temperature sensor malfunction occurs in fan mode, only the error code is displayed and the indoor unit will operate normally.
12	F4	Compressor Discharge Temperature Sensor Malfunction	Compressor Discharge Temperature Sensor	If outdoor unit detects the compressor discharge temperature sensor is open circuit or short circuit for 5-sec successively after the compressor has been operating for 3-min, outdoor discharge temperature sensor malfunction will be reported. The unit can automatically resume operation after the malfunction disappears.
13	F5	Wired Controller Temperature Sensor Malfunction	Wired Tether Controller Temperature Sensor	If the wired Tether Controller detects open circuit or short circuit of its temperature sensor for 5-sec successively, wired controller temperature sensor malfunction will be reported.

# DIAGNOSTIC CODES

## Error Codes

No.	Error Code	Malfunction Name	Origin of Malfunction	Description
14	ee	Outdoor Drive Memory Chip Malfunction	Outdoor Drive Board	If the memory chip of outdoor drive circuit board fails, the unit will not start. The unit will not recover automatically. If thermo junction cannot be eliminated after switching off the unit and then energizing the unit several times, replace the outdoor drive circuit board.
15	H3	Compressor Overload Protection	Compressor Overload Switch	If outdoor unit detects the compressor overload switch open within 3-sec successively, the unit will report compressor overload protection. If the fault occurs successively 3 times, the unit will not recover automatically. Switch off the unit or re-energize the unit to eliminate this protection.
16	H4	Overload Protection	Evaporator Temperature, Condenser Temperature	If indoor unit detects the evaporator coil temperature is higher than protective temp. value, the unit will report overload protection. The unit will restart operation after evaporator temperature is lower than the protective temp. value and the compressor is stopped for 3-minutes. If the protection occurs over 6 times, the unit will not recover automatically. Switch off the unit or re-energize the unit to eliminate this protection.
17	H6	Outdoor Fan Motor Malfunction	Outdoor Fan Motor	If outdoor unit does not receive feedback signal from outdoor fan motor for 30-sec successively when the fan motor is operating, an outdoor fan motor malfunction will be reported. In this case, the unit can automatically resume operation after stopping. If the malfunction occurs 6 times within one hour, the unit will not recover automatically. Switch off the unit or re-energize the unit to eliminate this malfunction.
18	U7	Reversing or 4-way Valve Malfunction	Reversing/ 4-way Valve	After the compressor starts operation in heating mode, if the outdoor unit detects the difference between evaporator temperature and indoor ambient temperature is lower than the protective value for 10-min successively, Reversing Valve Malfunction will be reported and the outdoor unit will stop operation. If the malfunction occurs 3 times, the unit will not recover automatically. Switch off the unit or re-energize the unit to eliminate this malfunction.
19	P6	Main Control and Drive Communication Malfunction	Communication Failure Between Indoor and Outdoor Main Board	If the outdoor main control board does not receive data from drive board, communication malfunction between main control and drive will be reported. The malfunction will be eliminated automatically.
20	EE	Outdoor Main Control Memory Chip Malfunction	Outdoor Main Control Board	If the memory chip on the outdoor main control board fails, the unit will not start. The unit will not recover automatically. If thermo junction cannot be eliminated after switching the unit off and on for several tries, replace the outdoor main control board.



**GREE ELECTRIC APPLIANCES, INC.**

www.greecomfort.com

**PRODUCT & INSTALLATION RECORD**

*For your convenience, please record the model and serial numbers of your new equipment in the spaces provided. This information, along with the installation data and dealer contact information, will be helpful should your system require maintenance or service.*

**UNIT INFORMATION**

Outdoor Unit:

Model No. \_\_\_\_\_

Serial No. \_\_\_\_\_

Indoor Unit:

Model No. \_\_\_\_\_

Serial No. \_\_\_\_\_

**INSTALLATION INFORMATION**

Date Installed: \_\_\_\_\_

**DEALERSHIP/INSTALLER INFORMATION**

Company Name: \_\_\_\_\_

Address: \_\_\_\_\_

\_\_\_\_\_

Phone Number: \_\_\_\_\_

Technician Name: \_\_\_\_\_

