



EDUS041701

**R-410A**

# Engineering Data

**Split Type Air Conditioners**

**- Cooling Only / Heat Pump -**

**FTX-N Series**

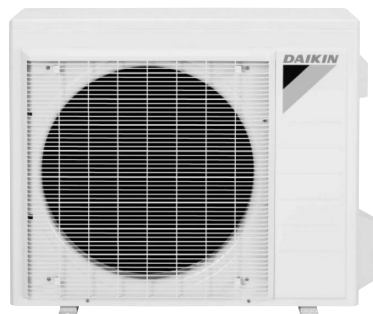
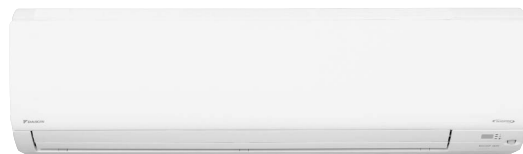

**INVERTER**



# Split Type Air Conditioners FTX-N Series

<b>Cooling Only</b>	<b>FTX30NVJU</b>	<b>RK30NMVJU</b>
	<b>FTX36NVJU</b>	<b>RK36NMVJU</b>
<b>Heat Pump</b>	<b>FTX30NVJU</b>	<b>RX30NMVJU</b>
	<b>FTX36NVJU</b>	<b>RX36NMVJU</b>

1. Power Supply .....	3
2. Functions.....	4
3. Specifications .....	5
3.1 Cooling Only .....	5
3.2 Heat Pump .....	6
4. Dimensions .....	7
4.1 Indoor Unit.....	7
4.2 Outdoor Unit.....	7
5. Wiring Diagrams.....	8
5.1 Indoor Unit.....	8
5.2 Outdoor Unit.....	8
6. Piping Diagrams.....	9
6.1 Indoor Unit.....	9
6.2 Outdoor Unit.....	10
7. Capacity Tables .....	11
7.1 Cooling Only.....	11
7.2 Heat Pump .....	15
7.3 Capacity Correction Factor by the Length of Refrigerant Piping (Reference) .....	21
8. Operation Limit.....	22
9. Sound Level .....	23
9.1 Measuring Location .....	23
9.2 Indoor Unit.....	23
9.3 Outdoor Unit.....	24
10. Electric Characteristics.....	25
11. Installation Manual .....	26
11.1 Indoor Unit.....	26
11.2 Outdoor Unit.....	36
12. Operation Manual.....	48

13. Optional Accessories .....	83
13.1 Option List .....	83
13.2 <BRC944B2> Wired Remote Controller.....	84
13.3 <BRP072A43> Wireless LAN Connection Adaptor.....	98
13.4 <KRP413AB1S> Wiring Adaptor for Timer Clock / Remote Controller ....	106
13.5 <KRP928BB2S> Interface Adaptor for DIII-NET (Residential Air Conditioner) .....	110
13.6 <KPW063A4> Air Direction Adjustment Grille.....	113
13.7 <KKG063A42> Back Protection Wire Net.....	115
13.8 <FTDBHML, KEH063A4E> Drain Pan Heater .....	116
13.9 <KPS063A41> Snow Hood (Intake Side Plate) .....	122
13.10<KPS063A44> Snow Hood (Intake Rear Plate) .....	124
13.11<KPS063A47> Snow Hood (Outlet) .....	126

**Cautions**

1. Air conditioners should not be installed in areas where corrosive gases, such as acid gas or alkaline gas, are produced.
2. If the outdoor unit is to be installed close to the sea shore, direct exposure to the sea breeze should be avoided and choose an outdoor unit with anti-corrosion treatment.



# 1. Power Supply

Indoor Unit	Outdoor Unit	Power Supply
FTX30NVJU	RK30NMVJU	1 phase, 208 - 230 V, 60 Hz
FTX36NVJU	RK36NMVJU	
FTX30NVJU	RX30NMVJU	
FTX30NVJU	RX30NMVJU	
FTX36NVJU	RX36NMVJU	

**Note:** Power Supply Intake ; Outdoor Unit

## 2. Functions

Category	Functions	FTX30/36NVJU RK30/36NMVJU		Category	Functions	FTX30/36NVJU RK30/36NMVJU		
		FTX30/36NVJU RK30/36NMVJU	FTX30/36NVJU RX30/36NMVJU			FTX30/36NVJU RK30/36NMVJU	FTX30/36NVJU RX30/36NMVJU	
Basic Functions	Inverter (with inverter power control)	●	●	Health & Cleanliness	Air-purifying filter	—	—	
	Operation limit for cooling	Refer to P. 22			Titanium apatite deodorizing filter	●	●	
	Operation limit for heating				Air filter (prefilter)	●	●	
	PAM control				●	●	Wipe-clean flat panel	●
	Standby electricity saving	●	●		Washable grille	—	—	
Compressor	Oval scroll compressor	—	—	Timer	MOLD PROOF operation	—	—	
	Swing compressor	●	●		Good-sleep cooling operation	—	—	
	Rotary compressor	—	—		WEEKLY TIMER	●	●	
	Reluctance DC motor	●	●		Count up-down ON/OFF timer	—	—	
Comfortable Airflow	Power-airflow flap (horizontal blade)	—	—	Worry Free (Reliability & Durability)	24-hour ON/OFF TIMER	●	●	
	Power-airflow dual flaps (horizontal blade)	●	●		NIGHT SET mode	●	●	
	Power-airflow diffuser	—	—		Auto-restart (after power failure)	●	●	
	Wide-angle louvers (vertical blade)	●	●		Self-diagnosis (R/C, LED)	●	●	
	Auto-swing (up and down)	●	●		Wiring error check function	—	—	
	Auto-swing (right and left)	●	●		Anti-corrosion treatment of outdoor heat exchanger	●	●	
	3-D airflow	●	●		Flexibility	Multi-split/split type compatible indoor unit	—	—
	COMFORT AIRFLOW operation	●	●			H/P, C/O compatible indoor unit	●	●
Comfort Control	Auto fan speed	●	●	Flexible power supply correspondence		—	—	
	Indoor unit quiet operation	●	●	Chargeless		32.8 ft (10 m)	32.8 ft (10 m)	
	NIGHT QUIET mode (automatic)	—	—	Either side drain (right or left)		●	●	
	OUTDOOR UNIT QUIET operation (manual)	●	●	Power selection		—	—	
	INTELLIGENT EYE operation	●	●	Low temperature cooling operation (–10°C) (14°F)		●★1	●★2	
	Quick warming function	—	●	°F/°C changeover R/C temperature display (factory setting: °F)		●	●	
	Hot-start function	—	●	Remote Control	Remote control adaptor (normal open-pulse contact) (option)	●	●	
	Automatic defrosting	—	●		Remote control adaptor (normal open contact) (option)	●	●	
Operation	Automatic operation	—	●		DIII-NET compatible (adaptor) (option)	●	●	
	Program dry function	●	●		Remote Controller	Wireless	●	●
	Fan only	●	●			Wired (option)	●	●
Lifestyle Convenience	POWERFUL operation (non-inverter)	—	—					
	POWERFUL operation (inverter)	●	●					
	Priority-room setting	—	—					
	COOL/HEAT mode lock	—	—					
	HOME LEAVE operation	—	—					
	ECONO operation	●	●					
	Indoor unit On/Off button	●	●					
	Signal receiving sign	●	●					
	R/C with back light	●	●					
	Temperature display	—	—					

**Note:** ● : Available  
— : Not available

★1 Extend operation range to –30°C (–22°F) with an air direction adjustment grille (sold separately).

★2 Extend operation range to –20°C (–4°F) with an air direction adjustment grille (sold separately).

### 3. Specifications

#### 3.1 Cooling Only

60 Hz, 208 - 230 V

Model	Indoor Unit		FTX30NVJU		FTX36NVJU	
	Outdoor Unit		RK30NMVJU		RK36NMVJU	
Capacity	Rated	Btu/h	31,400 - 31,400		33,200 - 34,400	
	Min. ~ Max.	Btu/h	10,200 - 10,200 ~ 31,400 - 31,400		10,200 - 10,200 ~ 33,200 - 34,400	
Running Current (Rated)		A	15.7 - 14.2		17 - 17	
Power Consumption	Rated	W	3,188 - 3,188		3,458 - 3,780	
	Min. ~ Max.	W	610 - 610 ~ 3,188 - 3,188		620 - 620 ~ 3,458 - 3,780	
Power Factor (Rated)		%	97.6 - 97.6		97.8 - 96.7	
SEER / HSPF			17.50		15.90	
COP (Rated)		W/W	—		—	
EER (Rated)		Btu/W·h	9.85		9.6 - 9.1	
Piping Connections	Liquid	in. (mm)	φ 1/4 (φ 6.4)		φ 1/4 (φ 6.4)	
	Gas	in. (mm)	φ 5/8 (φ 15.9)		φ 5/8 (φ 15.9)	
	Drain	in. (mm)	φ 5/8 (φ 16)		φ 5/8 (φ 16)	
Heat Insulation			Both Liquid and Gas Pipes		Both Liquid and Gas Pipes	
Max. Interunit Piping Length		ft (m)	98-3/8 (30)		98-3/8 (30)	
Max. Interunit Height Difference		ft (m)	65-5/8 (20)		65-5/8 (20)	
Chargeless		ft (m)	32-13/16 (10)		32-13/16 (10)	
Amount of Additional Charge of Refrigerant		oz/ft (g/m)	0.32 (30)		0.32 (30)	
<b>Indoor Unit</b>			<b>FTX30NVJU</b>		<b>FTX36NVJU</b>	
Front Panel Color			White		White	
Airflow Rate	H	cfm (m³/min)	890 (25.2)		915 (25.9)	
	M		727 (20.6)		742 (21.0)	
	L		572 (16.2)		572 (16.2)	
	SL		512 (14.5)		512 (14.5)	
Fan	Type		Cross Flow Fan		Cross Flow Fan	
	Speed	Steps	5 Steps, Quiet, Auto		5 Steps, Quiet, Auto	
Air Direction Control			Right, Left, Horizontal, Downward		Right, Left, Horizontal, Downward	
Air Filter			Removable, Washable, Mildew Proof		Removable, Washable, Mildew Proof	
Running Current (Rated)		A	0.8 - 0.7		0.8 - 0.8	
Power Consumption (Rated)		W	90.0 - 90.0		95.0 - 95.0	
Power Factor (Rated)		%	56.2 - 55.9		55.7 - 55.1	
Temperature Control			Microcomputer Control		Microcomputer Control	
Dimensions (H x W x D)		in. (mm)	13-3/8 x 47-1/4 x 10-3/16 (340 x 1,200 x 259)		13-3/8 x 47-1/4 x 10-3/16 (340 x 1,200 x 259)	
Packaged Dimensions (H x W x D)		in. (mm)	13-7/16 x 51-9/16 x 16-7/8 (342 x 1,310 x 429)		13-7/16 x 51-9/16 x 16-7/8 (342 x 1,310 x 429)	
Weight (Mass)		Lbs (kg)	38 (17)		38 (17)	
Gross Weight (Gross Mass)		Lbs (kg)	49 (22)		49 (22)	
Sound Pressure Level	H / M / L / SL	dB(A)	53 / 47 / 40 / 37		54 / 47 / 40 / 37	
<b>Outdoor Unit</b>			<b>RK30NMVJU</b>		<b>RK36NMVJU</b>	
Casing Color			Ivory White		Ivory White	
Compressor	Type		Hermetically Sealed Swing Type		Hermetically Sealed Swing Type	
	Model		2YC63AAXD		2YC63AAXD	
	Motor Output	W	1,920		1,920	
Refrigerant Oil	Type		FVC50K		FVC50K	
	Charge	oz (L)	30.44 (0.900)		30.44 (0.900)	
Refrigerant	Type		R-410A		R-410A	
	Charge	Lbs (kg)	3.64 (1.65)		3.64 (1.65)	
Airflow Rate	H	cfm (m³/min)	2,528 (71.6)		2,811 (79.6)	
Fan	Type		Propeller		Propeller	
Running Current (Rated)		A	14.93 - 13.50		16.18 - 16.25	
Power Consumption (Rated)		W	3,098 - 3,098		3,363 - 3,685	
Power Factor (Rated)		%	99.8 - 99.8		99.9 - 98.6	
Starting Current		A	15.70		17.00	
Dimensions (H x W x D)		in. (mm)	28-15/16 x 34-1/4 x 12-5/8 (735 x 870 x 320)		28-15/16 x 34-1/4 x 12-5/8 (735 x 870 x 320)	
Packaged Dimensions (H x W x D)		in. (mm)	31-7/8 x 41-9/16 x 18-1/4 (810 x 1,056 x 464)		31-7/8 x 41-9/16 x 18-1/4 (810 x 1,056 x 464)	
Weight (Mass)		Lbs (kg)	133 (60)		133 (60)	
Gross Weight (Gross Mass)		Lbs (kg)	142 (64)		142 (64)	
Sound Pressure Level		dB(A)	56		59	
Drawing No.			3D107929		3D107930	

- Notes:**
1. SL: The Quiet fan level of the airflow rate setting.
  2. The data are based on the conditions shown in the table below.

Cooling	Indoor ; 80.0°FDB (26.7°CDB) / 67.0°FWB (19.4°CWB) Outdoor ; 95.0°FDB (35°CDB) / 75°FWB (23.9°CWB)
Piping Length	25 ft (7.5 m)

Conversion Formulae
kcal/h = kW x 860 Btu/h = kW x 3412 cfm = m³/min x 35.3

### 3.2 Heat Pump

60 Hz, 208 - 230 V

Model	Indoor Unit		FTX30NVJU		FTX36NVJU	
	Outdoor Unit		RX30NMVJU		RX36NMVJU	
			Cooling	Heating	Cooling	Heating
Capacity	Rated	Btu/h	31,400 - 31,400	34,800 - 34,800	33,200 - 34,400	35,200 - 36,000
	Min. - Max.	Btu/h	10,200 - 10,200 ~ 31,400 - 31,400	10,200 - 10,200 ~ 34,800 - 34,800	10,200 - 10,200 ~ 33,200 - 34,400	10,200 - 10,200 ~ 35,200 - 36,000
Running Current (Rated)		A	15.7 - 14.2	17.3 - 15.6	17 - 17	18.1 - 17
Power Consumption	Rated	W	3,188 - 3,188	3,490 - 3,490	3,458 - 3,780	3,686 - 3,799
	Min. - Max.	W	610 - 610 ~ 3,188 - 3,188	690 - 690 ~ 3,490 - 3,490	620 - 620 ~ 3,458 - 3,780	690 - 690 ~ 3,686 - 3,799
Power Factor (Rated)		%	97.6 - 97.6	97.0 - 97.3	97.8 - 96.7	97.9 - 97.2
SEER / HSPF			17.50	9.30	15.90	9.20
COP (Rated)		W/W	—	2.92	—	2.80 - 2.78
EER (Rated)		Btu/W-h	9.85	—	9.6 - 9.1	—
Piping Connections	Liquid	in. (mm)	ϕ 1/4 (ϕ 6.4)		ϕ 1/4 (ϕ 6.4)	
	Gas	in. (mm)	ϕ 5/8 (ϕ 15.9)		ϕ 5/8 (ϕ 15.9)	
	Drain	in. (mm)	ϕ 5/8 (ϕ 16)		ϕ 5/8 (ϕ 16)	
Heat Insulation			Both Liquid and Gas Pipes		Both Liquid and Gas Pipes	
Max. Interunit Piping Length		ft (m)	98-3/8 (30)		98-3/8 (30)	
Max. Interunit Height Difference		ft (m)	65-5/8 (20)		65-5/8 (20)	
Chargeless		ft (m)	32-13/16 (10)		32-13/16 (10)	
Amount of Additional Charge of Refrigerant		oz/ft (g/m)	0.32 (30)		0.32 (30)	
<b>Indoor Unit</b>			<b>FTX30NVJU</b>		<b>FTX36NVJU</b>	
Front Panel Color			White		White	
Airflow Rate	H	cfm (m <sup>3</sup> /min)	890 (25.2)	960 (27.2)	915 (25.9)	960 (27.2)
	M		727 (20.6)	791 (22.4)	742 (21.0)	791 (22.4)
	L		572 (16.2)	629 (17.8)	572 (16.2)	629 (17.8)
	SL		512 (14.5)	544 (15.4)	512 (14.5)	544 (15.4)
Fan	Type		Cross Flow Fan		Cross Flow Fan	
	Speed	Steps	5 Steps, Quiet, Auto		5 Steps, Quiet, Auto	
Air Direction Control			Right, Left, Horizontal, Downward		Right, Left, Horizontal, Downward	
Air Filter			Removable, Washable, Mildew Proof		Removable, Washable, Mildew Proof	
Running Current (Rated)		A	0.77 - 0.70	0.82 - 0.75	0.82 - 0.75	0.82 - 0.75
Power Consumption (Rated)		W	90.0 - 90.0	95.0 - 95.0	95.0 - 95.0	95 - 95
Power Factor (Rated)		%	56.2 - 55.9	55.7 - 55.1	55.7 - 55.1	55.7 - 55.1
Temperature Control			Microcomputer Control		Microcomputer Control	
Dimensions (H x W x D)		in. (mm)	13-3/8 x 47-1/4 x 10-3/16 (340 x 1,200 x 259)		13-3/8 x 47-1/4 x 10-3/16 (340 x 1,200 x 259)	
Packaged Dimensions (H x W x D)		in. (mm)	13-7/16 x 51-9/16 x 16-7/8 (342 x 1,310 x 429)		13-7/16 x 51-9/16 x 16-7/8 (342 x 1,310 x 429)	
Weight (Mass)		Lbs (kg)	38 (17)		38 (17)	
Gross Weight (Gross Mass)		Lbs (kg)	49 (22)		49 (22)	
Sound Pressure Level		H / M / L / SL dB(A)	53 / 47 / 40 / 37	53 / 46 / 38 / 35	54 / 47 / 40 / 37	53 / 46 / 38 / 35
<b>Outdoor Unit</b>			<b>RX30NMVJU</b>		<b>RX36NMVJU</b>	
Casing Color			Ivory White		Ivory White	
Compressor	Type		Hermetically Sealed Swing Type		Hermetically Sealed Swing Type	
	Model		2YC63AAXD		2YC63AAXD	
	Motor Output	W	1,920		1,920	
Refrigerant Oil	Type		FVC50K		FVC50K	
	Charge	oz (L)	30.44 (0.900)		30.44 (0.900)	
Refrigerant	Type		R-410A		R-410A	
	Charge	Lbs (kg)	3.64 (1.65)		3.64 (1.65)	
Airflow Rate	H	cfm (m <sup>3</sup> /min)	2,528 (71.6)	2,274 (64.4)	2,811 (79.6)	2,352 (66.6)
Fan	Type		Propeller		Propeller	
Running Current (Rated)		A	14.93 - 13.50	16.48 - 14.85	16.18 - 16.25	17.28 - 16.25
Power Consumption (Rated)		W	3,098 - 3,098	3,395 - 3,395	3,363 - 3,685	3,591 - 3,704
Power Factor (Rated)		%	99.8 - 99.8	99.0 - 99.4	99.9 - 98.6	99.9 - 99.1
Starting Current		A	17.30		18.10	
Dimensions (H x W x D)		in. (mm)	28-15/16 x 34-1/4 x 12-5/8 (735 x 870 x 320)		28-15/16 x 34-1/4 x 12-5/8 (735 x 870 x 320)	
Packaged Dimensions (H x W x D)		in. (mm)	31-7/8 x 41-9/16 x 18-1/4 (810 x 1,056 x 464)		31-7/8 x 41-9/16 x 18-1/4 (810 x 1,056 x 464)	
Weight (Mass)		Lbs (kg)	133 (60)		133 (60)	
Gross Weight (Gross Mass)		Lbs (kg)	142 (64)		142 (64)	
Sound Pressure Level		dB(A)	56	58	59	59
Drawing No.			3D107927		3D107928	

**Notes:**

1. SL: The Quiet fan level of the airflow rate setting.
2. The data are based on the conditions shown in the table below.

Cooling	Indoor ; 80.0°FDB (26.7°CDB) / 67.0°FWB (19.4°CWB) Outdoor ; 95.0°FDB (35°CDB) / 75°FWB (23.9°CWB)
Heating	Indoor ; 70.0°FDB (21.1°CDB) / 60.0°FWB (15.6°CWB) Outdoor ; 47.0°FDB (8.33°CDB) / 43.0°FWB (6.11°CWB)
Piping Length	25 ft (7.5 m)

Conversion Formulae
kcal/h = kW x 860
Btu/h = kW x 3412
cfm = m <sup>3</sup> /min x 35.3

# 4. Dimensions

## 4.1 Indoor Unit

### FTX30/36NVJU

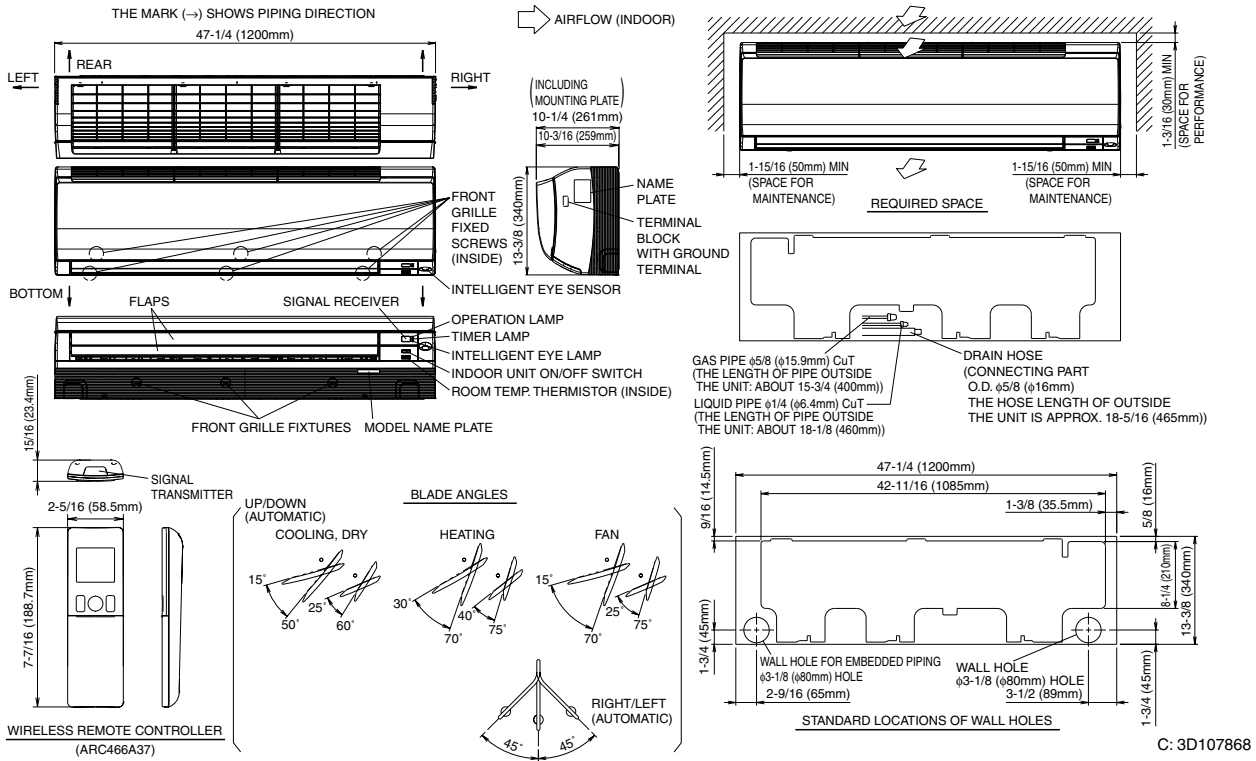

## 4.2 Outdoor Unit

### RK(X)30/36NMVJU

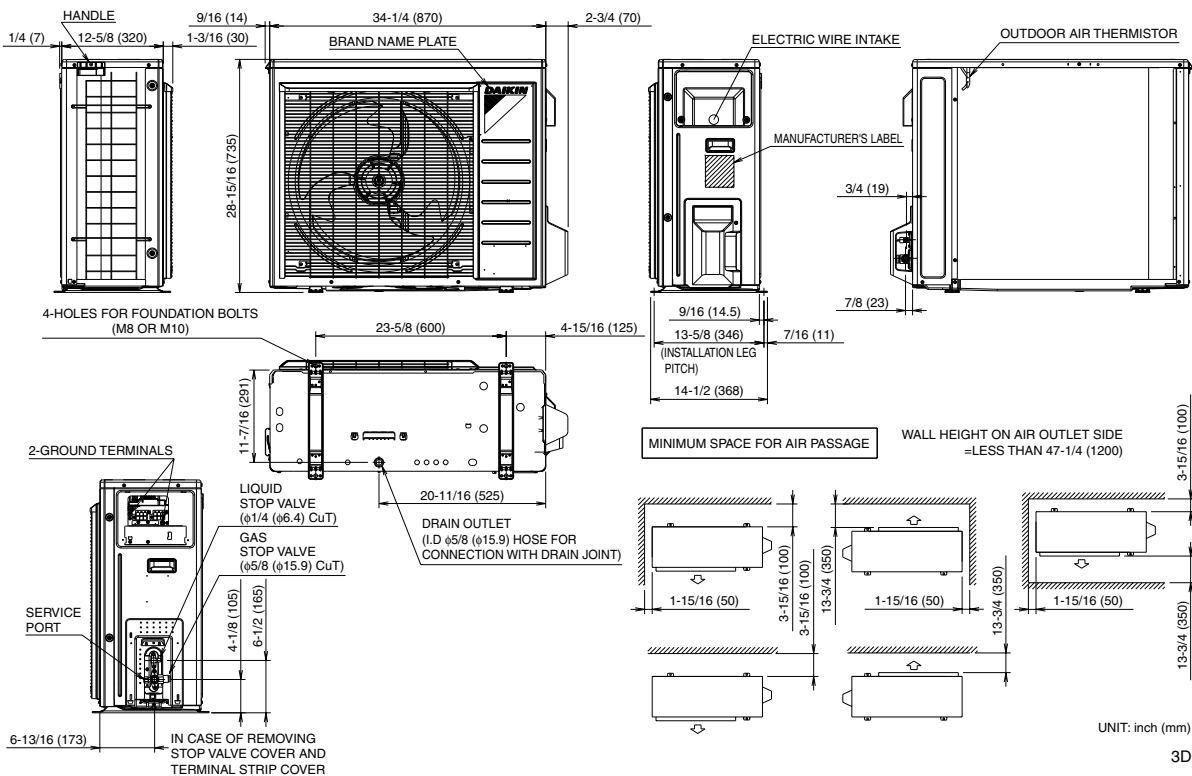

# 5. Wiring Diagrams

## 5.1 Indoor Unit

### FTX30/36NVJU

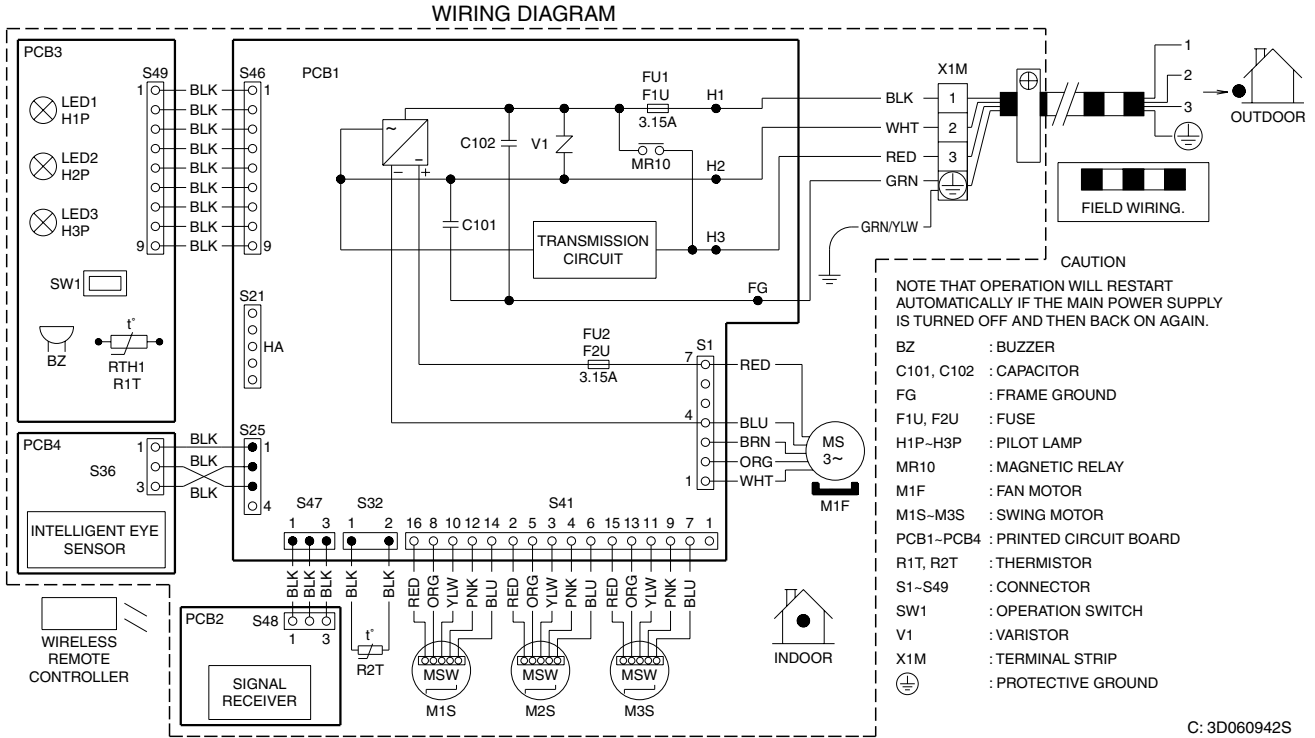

## 5.2 Outdoor Unit

### RK(X)30/36NMVJU

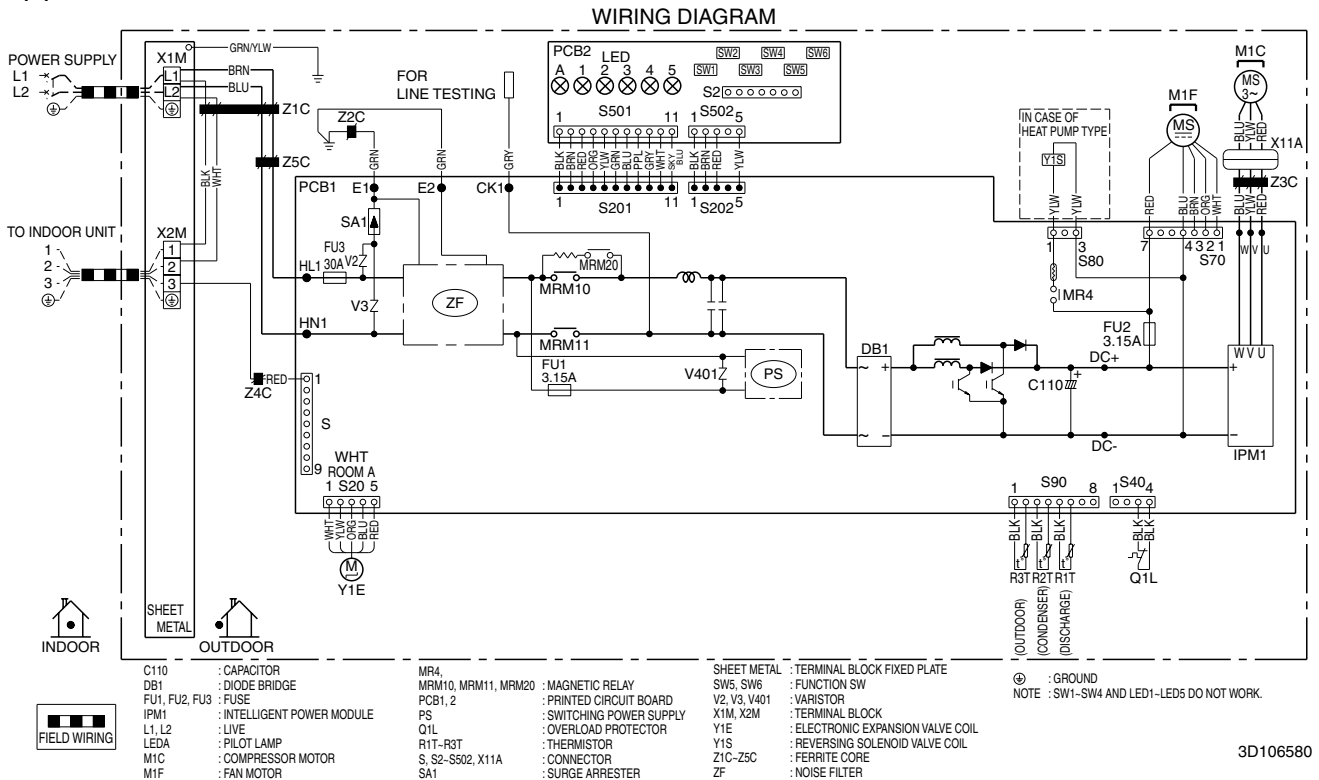

# 6. Piping Diagrams

## 6.1 Indoor Unit

FTX30/36NVJU

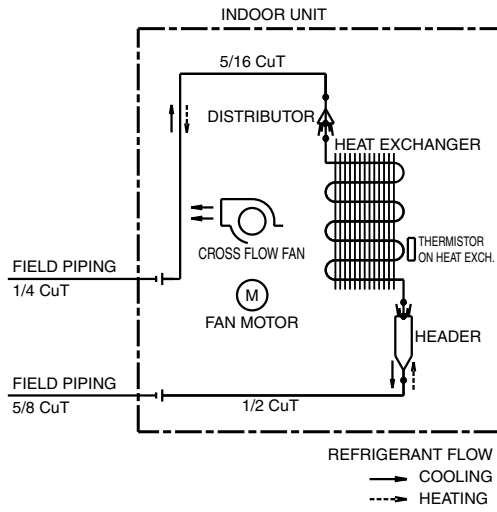

4D107870

## 6.2 Outdoor Unit

### 6.2.1 Cooling Only

#### RK30/36NMVJU

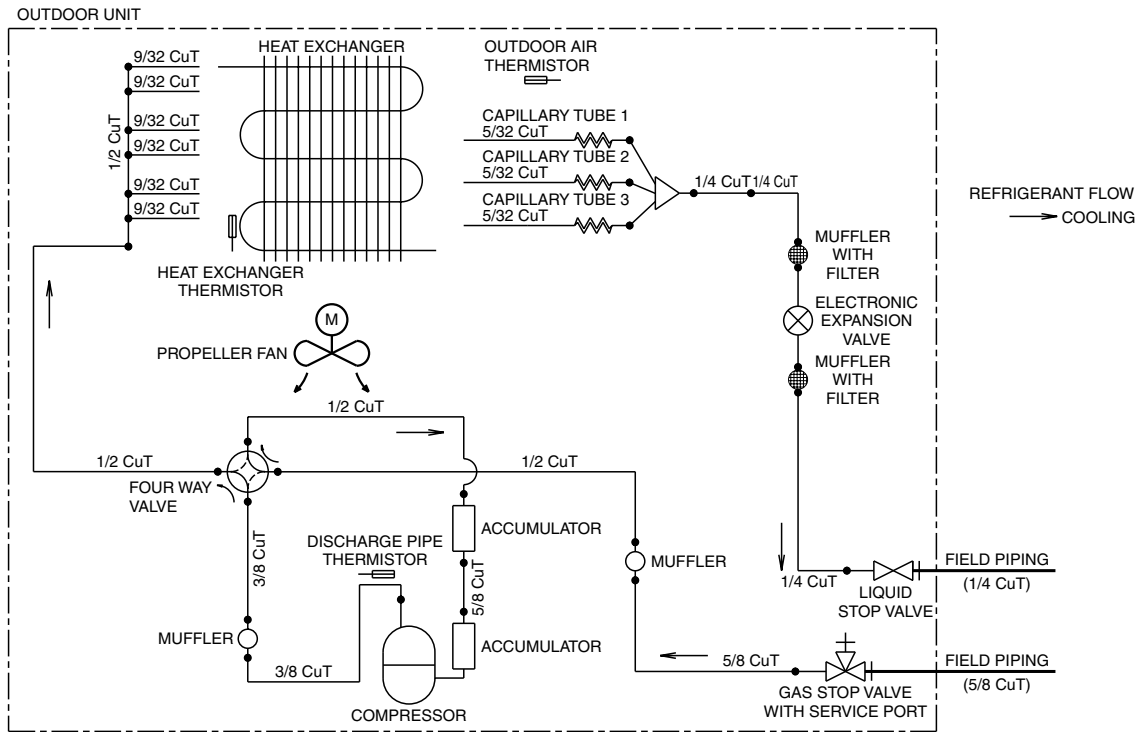

3D107986

### 6.2.2 Heat Pump

#### RX30/36NMVJU

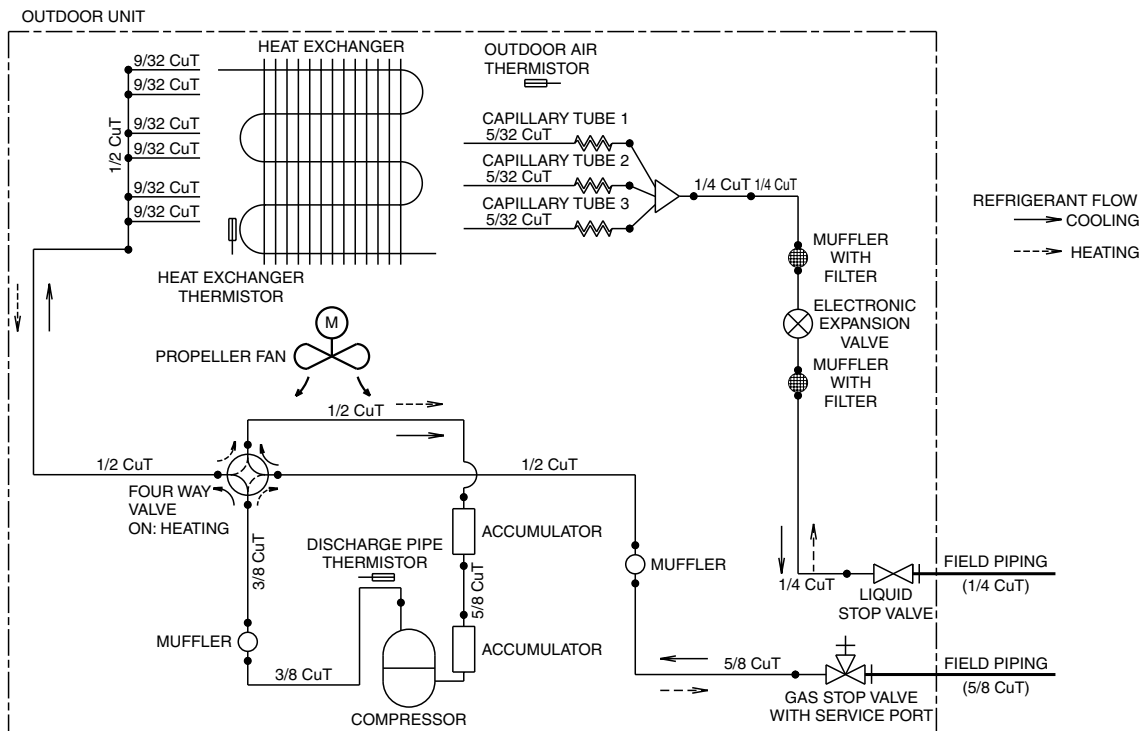

3D107985



# 7. Capacity Tables

## 7.1 Cooling Only

### FTX30NVJU + RK30NMVJU

AFR	25.22
BF	0.34

#### 60 Hz, 208 V

Temp: Celsius  
TC, SHC, PI: kW

INDOOR		OUTDOOR TEMPERATURE (°CDB)																	
EWB	EDB	10			20			30			35			40			46		
°C	°C	TC	SHC	PI	TC	SHC	PI	TC	SHC	PI	TC	SHC	PI	TC	SHC	PI	TC	SHC	PI
14.0	20.0	8.10	5.71	1.83	8.10	5.71	2.39	8.10	5.71	2.92	8.10	5.71	3.15	7.39	5.33	3.13	5.92	4.59	2.64
16.0	22.0	9.95	6.38	1.95	9.83	6.31	2.46	8.97	5.86	2.93	8.55	5.64	3.17	7.79	5.27	3.13	6.33	4.58	2.64
18.0	25.0	11.11	6.94	2.00	10.25	6.51	2.47	9.40	6.09	2.95	8.97	5.88	3.18	8.20	5.53	3.13	6.74	4.88	2.64
19.4	26.7	11.32	7.18	2.01	10.46	6.77	2.48	9.61	6.36	2.95	9.18	6.16	3.19	8.40	5.81	3.13	6.94	5.19	2.64
22.0	30.0	11.95	6.86	2.03	11.10	6.49	2.50	10.24	6.13	2.97	9.81	5.96	3.21	9.01	5.63	3.13	7.55	5.08	2.64
24.0	32.0	12.37	6.63	2.04	11.52	6.29	2.52	10.66	5.96	2.99	10.24	5.80	3.22	9.41	5.50	3.13	7.95	4.99	2.64

Temp: Fahrenheit  
TC, SHC: kBtu/h  
PI: kW

INDOOR		OUTDOOR TEMPERATURE (°FDB)																	
EWB	EDB	50			68			86			95			104			115		
°F	°F	TC	SHC	PI	TC	SHC	PI	TC	SHC	PI	TC	SHC	PI	TC	SHC	PI	TC	SHC	PI
57.2	68.0	27.65	19.47	1.83	27.65	19.47	2.39	27.65	19.47	2.92	27.65	19.47	3.15	25.20	18.18	3.13	20.21	15.67	2.64
60.8	71.6	33.96	21.76	1.95	33.53	21.53	2.46	30.62	20.00	2.93	29.16	19.26	3.17	26.58	17.98	3.13	21.60	15.62	2.64
64.4	77.0	37.89	23.68	2.00	34.98	22.20	2.47	32.06	20.77	2.95	30.60	20.08	3.18	27.97	18.85	3.13	22.98	16.64	2.64
67.0	80.0	38.61	24.51	2.01	35.70	23.08	2.48	32.78	21.70	2.95	31.40	21.03	3.19	28.66	19.84	3.13	23.68	17.70	2.64
71.6	86.0	40.78	23.42	2.03	37.86	22.15	2.50	34.95	20.92	2.97	33.49	20.32	3.21	30.74	19.23	3.13	25.75	17.33	2.64
75.2	89.6	42.22	22.62	2.04	39.31	21.46	2.52	36.39	20.33	2.99	34.93	19.79	3.22	32.12	18.76	3.13	27.14	17.02	2.64

#### 60 Hz, 230 V

Temp: Celsius  
TC, SHC, PI: kW

INDOOR		OUTDOOR TEMPERATURE (°CDB)																	
EWB	EDB	10			20			30			35			40			46		
°C	°C	TC	SHC	PI	TC	SHC	PI	TC	SHC	PI	TC	SHC	PI	TC	SHC	PI	TC	SHC	PI
14.0	20.0	8.10	5.71	1.83	8.10	5.71	2.39	8.10	5.71	2.92	8.10	5.71	3.15	7.70	5.49	3.39	6.26	4.76	2.92
16.0	22.0	9.95	6.38	1.95	9.83	6.31	2.46	8.97	5.86	2.93	8.55	5.64	3.17	8.12	5.43	3.40	6.67	4.74	2.92
18.0	25.0	11.11	6.94	2.00	10.25	6.51	2.47	9.40	6.09	2.95	8.97	5.88	3.18	8.54	5.68	3.42	7.08	5.02	2.92
19.4	26.7	11.32	7.18	2.01	10.46	6.77	2.48	9.61	6.36	2.95	9.18	6.16	3.19	8.75	5.97	3.42	7.28	5.33	2.92
22.0	30.0	11.95	6.86	2.03	11.10	6.49	2.50	10.24	6.13	2.97	9.81	5.96	3.21	9.39	5.78	3.44	7.89	5.21	2.92
24.0	32.0	12.37	6.63	2.04	11.52	6.29	2.52	10.66	5.96	2.99	10.24	5.80	3.22	9.81	5.64	3.46	8.29	5.11	2.92

Temp: Fahrenheit  
TC, SHC: kBtu/h  
PI: kW

INDOOR		OUTDOOR TEMPERATURE (°FDB)																	
EWB	EDB	50			68			86			95			104			115		
°F	°F	TC	SHC	PI	TC	SHC	PI	TC	SHC	PI	TC	SHC	PI	TC	SHC	PI	TC	SHC	PI
57.2	68.0	27.65	19.47	1.83	27.65	19.47	2.39	27.65	19.47	2.92	27.65	19.47	3.15	26.26	18.73	3.39	21.38	16.24	2.92
60.8	71.6	33.96	21.76	1.95	33.53	21.53	2.46	30.62	20.00	2.93	29.16	19.26	3.17	27.70	18.53	3.40	22.76	16.16	2.92
64.4	77.0	37.89	23.68	2.00	34.98	22.20	2.47	32.06	20.77	2.95	30.60	20.08	3.18	29.14	19.39	3.42	24.14	17.14	2.92
67.0	80.0	38.61	24.51	2.01	35.70	23.08	2.48	32.78	21.70	2.95	31.40	21.03	3.19	29.86	20.37	3.42	24.84	18.19	2.92
71.6	86.0	40.78	23.42	2.03	37.86	22.15	2.50	34.95	20.92	2.97	33.49	20.32	3.21	32.03	19.74	3.44	26.91	17.76	2.92
75.2	89.6	42.22	22.62	2.04	39.31	21.46	2.52	36.39	20.33	2.99	34.93	19.79	3.22	33.47	19.25	3.46	28.30	17.42	2.92

**Symbols:**

AFR	: Airflow rate	(m <sup>3</sup> /min.)
BF	: Bypass factor	
EWB	: Entering wet bulb temp.	(°C) / (°F)
EDB	: Entering dry bulb temp.	(°C) / (°F)
TC	: Total capacity	(kW) / (kBtu/h)
SHC	: Sensible heat capacity	(kW) / (kBtu/h)
PI	: Power input	(kW)

**Notes:**

1. ■ shows nominal (rated) capacities and power input.
2. TC, PI and SHC must be calculated by interpolation using the figures in the above tables. (Figures out of the tables should not be used for calculation.)
3. Capacities are based on the following conditions.  
Corresponding refrigerant piping length : 25 ft (7.5 m)  
Level difference : 0 ft (0 m)
4. Airflow rate (AFR) and bypass factor (BF) are tabulated above table.

3D108103

**FTX36NVJU + RK36NMVJU**

AFR	25.92
BF	0.34

**60 Hz, 208 V**

Temp: Celsius  
TC, SHC, PI: kW

INDOOR		OUTDOOR TEMPERATURE (°CDB)																	
EWB	EDB	10			20			30			35			40			46		
		°C	°C	TC	SHC	PI	TC	SHC	PI	TC	SHC	PI	TC	SHC	PI	TC	SHC	PI	
14.0	20.0	8.33	5.87	1.99	8.33	5.87	2.62	8.33	5.87	3.16	8.33	5.87	3.42	7.55	5.45	3.14	6.02	4.69	2.64
16.0	22.0	10.23	6.55	2.10	10.23	6.55	2.66	9.56	6.20	3.18	9.10	5.96	3.44	7.98	5.40	3.14	6.45	4.68	2.64
18.0	25.0	11.83	7.35	2.17	10.92	6.88	2.68	10.01	6.43	3.19	9.55	6.21	3.45	8.41	5.67	3.14	6.89	5.00	2.64
19.4	26.7	12.06	7.60	2.18	11.15	7.14	2.69	10.24	6.71	3.20	9.78	6.49	3.46	8.63	5.97	3.14	7.10	5.32	2.64
22.0	30.0	12.73	7.25	2.20	11.82	6.85	2.71	10.91	6.46	3.23	10.46	6.27	3.48	9.27	5.80	3.14	7.75	5.22	2.64
24.0	32.0	13.18	7.00	2.22	12.27	6.63	2.73	11.36	6.28	3.24	10.91	6.10	3.50	9.71	5.66	3.14	8.18	5.13	2.64

Temp: Fahrenheit  
TC, SHC: kBtu/h  
PI: kW

INDOOR		OUTDOOR TEMPERATURE (°FDB)																	
EWB	EDB	50			68			86			95			104			115		
		°F	°F	TC	SHC	PI	TC	SHC	PI	TC	SHC	PI	TC	SHC	PI	TC	SHC	PI	
57.2	68.0	28.42	20.01	1.99	28.42	20.01	2.62	28.42	20.01	3.16	28.42	20.01	3.42	25.75	18.61	3.14	20.55	15.99	2.64
60.8	71.6	34.90	22.36	2.10	34.90	22.36	2.66	32.62	21.15	3.18	31.06	20.35	3.44	27.22	18.43	3.14	22.02	15.97	2.64
64.4	77.0	40.37	25.08	2.17	37.26	23.48	2.68	34.15	21.93	3.19	32.60	21.18	3.45	28.70	19.35	3.14	23.49	17.05	2.64
67.0	80.0	41.14	25.92	2.18	38.03	24.38	2.69	34.92	22.88	3.20	33.20	22.16	3.46	29.43	20.38	3.14	24.23	18.15	2.64
71.6	86.0	43.44	24.75	2.20	40.34	23.38	2.71	37.23	22.05	3.23	35.68	21.40	3.48	31.64	19.78	3.14	26.44	17.80	2.64
75.2	89.6	44.98	23.90	2.22	41.87	22.64	2.73	38.77	21.42	3.24	37.21	20.83	3.50	33.12	19.32	3.14	27.92	17.50	2.64

**60 Hz, 230 V**

Temp: Celsius  
TC, SHC, PI: kW

INDOOR		OUTDOOR TEMPERATURE (°CDB)																	
EWB	EDB	10			20			30			35			40			46		
		°C	°C	TC	SHC	PI	TC	SHC	PI	TC	SHC	PI	TC	SHC	PI	TC	SHC	PI	
14.0	20.0	8.33	5.87	2.21	8.33	5.87	2.90	8.33	5.87	3.46	8.33	5.87	3.74	7.74	5.55	3.43	6.11	4.73	2.89
16.0	22.0	10.23	6.55	2.30	10.23	6.55	2.92	9.85	6.35	3.48	9.38	6.11	3.75	8.18	5.50	3.43	6.55	4.72	2.89
18.0	25.0	12.19	7.54	2.37	11.26	7.05	2.93	10.32	6.58	3.49	9.85	6.35	3.77	8.63	5.77	3.43	6.99	5.04	2.89
19.4	26.7	12.43	7.79	2.38	11.49	7.31	2.94	10.55	6.86	3.50	10.08	6.63	3.78	8.85	6.07	3.43	7.22	5.37	2.89
22.0	30.0	13.12	7.43	2.41	12.18	7.01	2.97	11.25	6.60	3.53	10.78	6.41	3.81	9.51	5.89	3.43	7.88	5.27	2.89
24.0	32.0	13.59	7.17	2.42	12.65	6.79	2.98	11.71	6.41	3.54	11.24	6.23	3.82	9.96	5.75	3.43	8.33	5.18	2.89

Temp: Fahrenheit  
TC, SHC: kBtu/h  
PI: kW

INDOOR		OUTDOOR TEMPERATURE (°FDB)																	
EWB	EDB	50			68			86			95			104			115		
		°F	°F	TC	SHC	PI	TC	SHC	PI	TC	SHC	PI	TC	SHC	PI	TC	SHC	PI	
57.2	68.0	28.42	20.01	2.21	28.42	20.01	2.90	28.42	20.01	3.46	28.42	20.01	3.74	26.40	18.95	3.43	20.83	16.13	2.89
60.8	71.6	34.90	22.36	2.30	34.90	22.36	2.92	33.62	21.68	3.48	32.02	20.84	3.75	27.92	18.77	3.43	22.35	16.12	2.89
64.4	77.0	41.61	25.74	2.37	38.41	24.06	2.93	35.20	22.45	3.49	33.60	21.66	3.77	29.43	19.69	3.43	23.86	17.21	2.89
67.0	80.0	42.40	26.57	2.38	39.20	24.95	2.94	35.99	23.39	3.50	34.40	22.63	3.78	30.19	20.71	3.43	24.62	18.31	2.89
71.6	86.0	44.78	25.36	2.41	41.57	23.92	2.97	38.37	22.53	3.53	36.77	21.86	3.81	32.46	20.10	3.43	26.89	17.97	2.89
75.2	89.6	46.36	24.47	2.42	43.16	23.15	2.98	39.96	21.88	3.54	38.35	21.26	3.82	33.98	19.63	3.43	28.41	17.67	2.89

**Symbols:**

AFR	: Airflow rate	(m <sup>3</sup> /min.)
BF	: Bypass factor	
EWB	: Entering wet bulb temp.	(°C) / (°F)
EDB	: Entering dry bulb temp.	(°C) / (°F)
TC	: Total capacity	(kW) / (kBtu/h)
SHC	: Sensible heat capacity	(kW) / (kBtu/h)
PI	: Power input	(kW)

**Notes:**

1. ■ shows nominal (rated) capacities and power input.
2. TC, PI and SHC must be calculated by interpolation using the figures in the above tables. (Figures out of the tables should not be used for calculation.)
3. Capacities are based on the following conditions.  
Corresponding refrigerant piping length : 25 ft (7.5 m)  
Level difference : 0 ft (0 m)
4. Airflow rate (AFR) and bypass factor (BF) are tabulated above table.

3D108104

## 7.2 Heat Pump

### FTX30NVJU + RX30NMVJU

60 Hz, 208 V

#### Cooling

AFR	25.22
BF	0.34

Temp: Celsius  
TC, SHC, PI: kW

INDOOR		OUTDOOR TEMPERATURE (°CDB)																	
EWB	EDB	10			20			30			35			40			46		
		°C	°C	TC	SHC	PI	TC	SHC	PI	TC	SHC	PI	TC	SHC	PI	TC	SHC	PI	TC
14.0	20.0	8.10	5.71	1.83	8.10	5.71	2.39	8.10	5.71	2.92	8.10	5.71	3.15	7.39	5.33	3.13	5.92	4.59	2.64
16.0	22.0	9.95	6.38	1.95	9.83	6.31	2.46	8.97	5.86	2.93	8.55	5.64	3.17	7.79	5.27	3.13	6.33	4.58	2.64
18.0	25.0	11.11	6.94	2.00	10.25	6.51	2.47	9.40	6.09	2.95	8.97	5.88	3.18	8.20	5.53	3.13	6.74	4.88	2.64
19.4	26.7	11.32	7.18	2.01	10.46	6.77	2.48	9.61	6.36	2.95	9.18	6.16	3.19	8.40	5.81	3.13	6.94	5.19	2.64
22.0	30.0	11.95	6.86	2.03	11.10	6.49	2.50	10.24	6.13	2.97	9.81	5.96	3.21	9.01	5.63	3.13	7.55	5.08	2.64
24.0	32.0	12.37	6.63	2.04	11.52	6.29	2.52	10.66	5.96	2.99	10.24	5.80	3.22	9.41	5.50	3.13	7.95	4.99	2.64

Temp: Fahrenheit  
TC, SHC: kBtu/h  
PI: kW

INDOOR		OUTDOOR TEMPERATURE (°FDB)																	
EWB	EDB	50			68			86			95			104			115		
		°F	°F	TC	SHC	PI	TC	SHC	PI	TC	SHC	PI	TC	SHC	PI	TC	SHC	PI	TC
57.2	68.0	27.65	19.47	1.83	27.65	19.47	2.39	27.65	19.47	2.92	27.65	19.47	3.15	25.20	18.18	3.13	20.21	15.67	2.64
60.8	71.6	33.96	21.76	1.95	33.53	21.53	2.46	30.62	20.00	2.93	29.16	19.26	3.17	26.58	17.98	3.13	21.60	15.62	2.64
64.4	77.0	37.89	23.68	2.00	34.98	22.20	2.47	32.06	20.77	2.95	30.60	20.08	3.18	27.97	18.85	3.13	22.98	16.64	2.64
67.0	80.0	38.61	24.51	2.01	35.70	23.08	2.48	32.78	21.70	2.95	31.40	21.03	3.19	28.66	19.84	3.13	23.68	17.70	2.64
71.6	86.0	40.78	23.42	2.03	37.86	22.15	2.50	34.95	20.92	2.97	33.49	20.32	3.21	30.74	19.23	3.13	25.75	17.33	2.64
75.2	89.6	42.22	22.62	2.04	39.31	21.46	2.52	36.39	20.33	2.99	34.93	19.79	3.22	32.12	18.76	3.13	27.14	17.02	2.64

#### Heating

AFR	27.2
-----	------

Temp: Celsius  
TC, PI: kW

INDOOR		OUTDOOR TEMPERATURE (°CWB)													
EDB	°C	-15		-10		-5		0		6		10		18	
		TC	PI	TC	PI	TC	PI	TC	PI	TC	PI	TC	PI	TC	PI
15.0	4.86	2.53	5.84	2.66	6.82	2.79	7.79	2.92	10.55	3.41	11.47	3.53	13.32	3.76	
21.1	4.56	2.60	5.54	2.73	6.52	2.86	7.50	2.99	10.20	3.49	11.12	3.60	12.96	3.83	
22.0	4.44	2.63	5.42	2.76	6.40	2.88	7.38	3.01	10.06	3.52	10.98	3.64	12.82	3.87	
24.0	4.32	2.65	5.30	2.78	6.28	2.91	7.26	3.04	9.92	3.55	10.84	3.67	12.68	3.90	
25.0	4.26	2.67	5.24	2.80	6.22	2.93	7.20	3.06	9.85	3.57	10.77	3.68	12.61	3.91	
27.0	4.14	2.70	5.12	2.83	6.10	2.96	7.08	3.08	9.71	3.60	10.63	3.72	12.47	3.94	

Temp: Fahrenheit  
TC: kBtu/h  
PI: kW

INDOOR		OUTDOOR TEMPERATURE (°FWB)													
EDB	°F	5		14		23		32		43		50		64	
		TC	PI	TC	PI	TC	PI	TC	PI	TC	PI	TC	PI	TC	PI
59.0	16.57	2.53	19.91	2.66	23.25	2.79	26.59	2.92	36.00	3.41	39.15	3.53	45.44	3.76	
70.0	15.55	2.60	18.89	2.73	22.23	2.86	25.57	2.99	34.80	3.49	37.95	3.60	44.23	3.83	
71.6	15.14	2.63	18.48	2.76	21.82	2.88	25.17	3.01	34.32	3.52	37.47	3.64	43.75	3.87	
75.2	14.74	2.65	18.08	2.78	21.42	2.91	24.76	3.04	33.84	3.55	36.99	3.67	43.27	3.90	
77.0	14.53	2.67	17.87	2.80	21.21	2.93	24.55	3.06	33.60	3.57	36.74	3.68	43.03	3.91	
80.6	14.12	2.70	17.46	2.83	20.80	2.96	24.14	3.08	33.12	3.60	36.26	3.72	42.55	3.94	

60 Hz, 230 V

Cooling

AFR	25.22
BF	0.34

Temp: Celsius  
TC, SHC, PI: kW

INDOOR		OUTDOOR TEMPERATURE (°CDB)																	
EWB	EDB	10			20			30			35			40			46		
		TC	SHC	PI	TC	SHC	PI	TC	SHC	PI	TC	SHC	PI	TC	SHC	PI	TC	SHC	PI
14.0	20.0	8.10	5.71	1.83	8.10	5.71	2.39	8.10	5.71	2.92	8.10	5.71	3.15	7.70	5.49	3.39	6.26	4.76	2.92
16.0	22.0	9.95	6.38	1.95	9.83	6.31	2.46	8.97	5.86	2.93	8.55	5.64	3.17	8.12	5.43	3.40	6.67	4.74	2.92
18.0	25.0	11.11	6.94	2.00	10.25	6.51	2.47	9.40	6.09	2.95	8.97	5.88	3.18	8.54	5.68	3.42	7.08	5.02	2.92
19.4	26.7	11.32	7.18	2.01	10.46	6.77	2.48	9.61	6.36	2.95	9.18	6.16	3.19	8.75	5.97	3.42	7.28	5.33	2.92
22.0	30.0	11.95	6.86	2.03	11.10	6.49	2.50	10.24	6.13	2.97	9.81	5.96	3.21	9.39	5.78	3.44	7.89	5.21	2.92
24.0	32.0	12.37	6.63	2.04	11.52	6.29	2.52	10.66	5.96	2.99	10.24	5.80	3.22	9.81	5.64	3.46	8.29	5.11	2.92

Temp: Fahrenheit  
TC, SHC: kBtu/h  
PI: kW

INDOOR		OUTDOOR TEMPERATURE (°FDB)																	
EWB	EDB	50			68			86			95			104			115		
		TC	SHC	PI	TC	SHC	PI	TC	SHC	PI	TC	SHC	PI	TC	SHC	PI	TC	SHC	PI
57.2	68.0	27.65	19.47	1.83	27.65	19.47	2.39	27.65	19.47	2.92	27.65	19.47	3.15	26.26	18.73	3.39	21.38	16.24	2.92
60.8	71.6	33.96	21.76	1.95	33.53	21.53	2.46	30.62	20.00	2.93	29.16	19.26	3.17	27.70	18.53	3.40	22.76	16.16	2.92
64.4	77.0	37.89	23.68	2.00	34.98	22.20	2.47	32.06	20.77	2.95	30.60	20.08	3.18	29.14	19.39	3.42	24.14	17.14	2.92
67.0	80.0	38.61	24.51	2.01	35.70	23.08	2.48	32.78	21.70	2.95	31.40	21.03	3.19	29.86	20.37	3.42	24.84	18.19	2.92
71.6	86.0	40.78	23.42	2.03	37.86	22.15	2.50	34.95	20.92	2.97	33.49	20.32	3.21	32.03	19.74	3.44	26.91	17.76	2.92
75.2	89.6	42.22	22.62	2.04	39.31	21.46	2.52	36.39	20.33	2.99	34.93	19.79	3.22	33.47	19.25	3.46	28.30	17.42	2.92

Heating

AFR	27.2
-----	------

Temp: Celsius  
TC, PI: kW

INDOOR		OUTDOOR TEMPERATURE (°CWB)													
EDB	°C	-15		-10		-5		0		6		10		18	
		TC	PI	TC	PI	TC	PI	TC	PI	TC	PI	TC	PI	TC	PI
15.0	4.86	2.53	5.84	2.66	6.82	2.79	7.79	2.92	10.55	3.41	11.47	3.53	13.32	3.76	
21.1	4.56	2.60	5.54	2.73	6.52	2.86	7.50	2.99	10.20	3.49	11.12	3.60	12.96	3.83	
22.0	4.44	2.63	5.42	2.76	6.40	2.88	7.38	3.01	10.06	3.52	10.98	3.64	12.82	3.87	
24.0	4.32	2.65	5.30	2.78	6.28	2.91	7.26	3.04	9.92	3.55	10.84	3.67	12.68	3.90	
25.0	4.26	2.67	5.24	2.80	6.22	2.93	7.20	3.06	9.85	3.57	10.77	3.68	12.61	3.91	
27.0	4.14	2.70	5.12	2.83	6.10	2.96	7.08	3.08	9.71	3.60	10.63	3.72	12.47	3.94	

Temp: Fahrenheit  
TC: kBtu/h  
PI: kW

INDOOR		OUTDOOR TEMPERATURE (°FWB)													
EDB	°F	5		14		23		32		43		50		64	
		TC	PI	TC	PI	TC	PI	TC	PI	TC	PI	TC	PI	TC	PI
59.0	16.57	2.53	19.91	2.66	23.25	2.79	26.59	2.92	36.00	3.41	39.15	3.53	45.44	3.76	
70.0	15.55	2.60	18.89	2.73	22.23	2.86	25.57	2.99	34.80	3.49	37.95	3.60	44.23	3.83	
71.6	15.14	2.63	18.48	2.76	21.82	2.88	25.17	3.01	34.32	3.52	37.47	3.64	43.75	3.87	
75.2	14.74	2.65	18.08	2.78	21.42	2.91	24.76	3.04	33.84	3.55	36.99	3.67	43.27	3.90	
77.0	14.53	2.67	17.87	2.80	21.21	2.93	24.55	3.06	33.60	3.57	36.74	3.68	43.03	3.91	
80.6	14.12	2.70	17.46	2.83	20.80	2.96	24.14	3.08	33.12	3.60	36.26	3.72	42.55	3.94	

**Symbols:**

AFR	: Airflow rate	(m <sup>3</sup> /min.)
BF	: Bypass factor	
EWB	: Entering wet bulb temp.	(°C) / (°F)
EDB	: Entering dry bulb temp.	(°C) / (°F)
TC	: Total capacity	(kW) / (kBtu/h)
SHC	: Sensible heat capacity	(kW) / (kBtu/h)
PI	: Power input	(kW)

**Notes:**

1. ■ shows nominal (rated) capacities and power input.
2. TC, PI and SHC must be calculated by interpolation using the figures in the above tables. (Figures out of the tables should not be used for calculation.)
3. Capacities are based on the following conditions.  
Corresponding refrigerant piping length : 25 ft (7.5 m)  
Level difference : 0 ft (0 m)
4. Airflow rate (AFR) and bypass factor (BF) are tabulated above table.

3D108101

## FTX36NVJU + RX36NMVJU

60 Hz, 208 V

## Cooling

AFR	25.92
BF	0.34

Temp: Celsius

TC, SHC, PI: kW

INDOOR		OUTDOOR TEMPERATURE (°CDB)																	
EWB	EDB	10			20			30			35			40			46		
		°C	°C	TC	SHC	PI	TC	SHC	PI	TC	SHC	PI	TC	SHC	PI	TC	SHC	PI	TC
14.0	20.0	8.33	5.87	1.99	8.33	5.87	2.62	8.33	5.87	3.16	8.33	5.87	3.42	7.55	5.45	3.14	6.02	4.69	2.64
16.0	22.0	10.23	6.55	2.10	10.23	6.55	2.66	9.56	6.20	3.18	9.10	5.96	3.44	7.98	5.40	3.14	6.45	4.68	2.64
18.0	25.0	11.83	7.35	2.17	10.92	6.88	2.68	10.01	6.43	3.19	9.55	6.21	3.45	8.41	5.67	3.14	6.89	5.00	2.64
19.4	26.7	12.06	7.60	2.18	11.15	7.14	2.69	10.24	6.71	3.20	9.78	6.49	3.46	8.63	5.97	3.14	7.10	5.32	2.64
22.0	30.0	12.73	7.25	2.20	11.82	6.85	2.71	10.91	6.46	3.23	10.46	6.27	3.48	9.27	5.80	3.14	7.75	5.22	2.64
24.0	32.0	13.18	7.00	2.22	12.27	6.63	2.73	11.36	6.28	3.24	10.91	6.10	3.50	9.71	5.66	3.14	8.18	5.13	2.64

Temp: Fahrenheit

TC, SHC: kBtu/h

PI: kW

INDOOR		OUTDOOR TEMPERATURE (°FDB)																	
EWB	EDB	50			68			86			95			104			115		
		°F	°F	TC	SHC	PI	TC	SHC	PI	TC	SHC	PI	TC	SHC	PI	TC	SHC	PI	TC
57.2	68.0	28.42	20.01	1.99	28.42	20.01	2.62	28.42	20.01	3.16	28.42	20.01	3.42	25.75	18.61	3.14	20.55	15.99	2.64
60.8	71.6	34.90	22.36	2.10	34.90	22.36	2.66	32.62	21.15	3.18	31.06	20.35	3.44	27.22	18.43	3.14	22.02	15.97	2.64
64.4	77.0	40.37	25.08	2.17	37.26	23.48	2.68	34.15	21.93	3.19	32.60	21.18	3.45	28.70	19.35	3.14	23.49	17.05	2.64
67.0	80.0	41.14	25.92	2.18	38.03	24.38	2.69	34.92	22.88	3.20	33.20	22.16	3.46	29.43	20.38	3.14	24.23	18.15	2.64
71.6	86.0	43.44	24.75	2.20	40.34	23.38	2.71	37.23	22.05	3.23	35.68	21.40	3.48	31.64	19.78	3.14	26.44	17.80	2.64
75.2	89.6	44.98	23.90	2.22	41.87	22.64	2.73	38.77	21.42	3.24	37.21	20.83	3.50	33.12	19.32	3.14	27.92	17.50	2.64

## Heating

AFR	27.2
-----	------

Temp: Celsius

TC, PI: kW

INDOOR		OUTDOOR TEMPERATURE (°CWB)													
EDB	°C	-15		-10		-5		0		6		10		18	
		TC	PI	TC	PI	TC	PI	TC	PI	TC	PI	TC	PI	TC	PI
15.0	4.91	2.67	5.91	2.81	6.90	2.94	7.89	3.08	10.68	3.60	11.61	3.72	13.47	3.97	
21.1	4.61	2.74	5.60	2.88	6.59	3.02	7.58	3.15	10.32	3.69	11.25	3.81	13.12	4.05	
22.0	4.49	2.77	5.48	2.91	6.47	3.05	7.46	3.18	10.18	3.72	11.11	3.84	12.97	4.08	
24.0	4.37	2.80	5.36	2.94	6.35	3.08	7.34	3.21	10.04	3.75	10.97	3.87	12.83	4.12	
25.0	4.31	2.82	5.30	2.95	6.29	3.09	7.28	3.23	9.96	3.77	10.90	3.89	12.76	4.13	
27.0	4.19	2.85	5.18	2.98	6.17	3.12	7.16	3.26	9.82	3.80	10.75	3.92	12.62	4.17	

Temp: Fahrenheit

TC: kBtu/h

PI: kW

INDOOR		OUTDOOR TEMPERATURE (°FWB)													
EDB	°F	5		14		23		32		43		50		64	
		TC	PI	TC	PI	TC	PI	TC	PI	TC	PI	TC	PI	TC	PI
59.0	16.77	2.67	20.15	2.81	23.53	2.94	26.91	3.08	36.43	3.60	39.61	3.72	45.97	3.97	
70.0	15.74	2.74	19.12	2.88	22.49	3.02	25.87	3.15	35.20	3.69	38.39	3.81	44.75	4.05	
71.6	15.32	2.77	18.70	2.91	22.08	3.05	25.46	3.18	34.73	3.72	37.91	3.84	44.27	4.08	
75.2	14.91	2.80	18.29	2.94	21.67	3.08	25.05	3.21	34.24	3.75	37.42	3.87	43.78	4.12	
77.0	14.70	2.82	18.08	2.95	21.46	3.09	24.84	3.23	34.00	3.77	37.18	3.89	43.54	4.13	
80.6	14.29	2.85	17.67	2.98	21.05	3.12	24.43	3.26	33.51	3.80	36.69	3.92	43.05	4.17	



60 Hz, 230 V

Cooling

AFR	25.92
BF	0.34

Temp: Celsius  
TC, SHC, PI: kW

INDOOR		OUTDOOR TEMPERATURE (°CDB)																	
EWB	EDB	10			20			30			35			40			46		
		TC	SHC	PI	TC	SHC	PI	TC	SHC	PI	TC	SHC	PI	TC	SHC	PI	TC	SHC	PI
14.0	20.0	8.33	5.87	2.21	8.33	5.87	2.90	8.33	5.87	3.46	8.33	5.87	3.74	7.74	5.55	3.43	6.11	4.73	2.89
16.0	22.0	10.23	6.55	2.30	10.23	6.55	2.92	9.85	6.35	3.48	9.38	6.11	3.75	8.18	5.50	3.43	6.55	4.72	2.89
18.0	25.0	12.19	7.54	2.37	11.26	7.05	2.93	10.32	6.58	3.49	9.85	6.35	3.77	8.63	5.77	3.43	6.99	5.04	2.89
19.4	26.7	12.43	7.79	2.38	11.49	7.31	2.94	10.55	6.86	3.50	10.08	6.63	3.78	8.85	6.07	3.43	7.22	5.37	2.89
22.0	30.0	13.12	7.43	2.41	12.18	7.01	2.97	11.25	6.60	3.53	10.78	6.41	3.81	9.51	5.89	3.43	7.88	5.27	2.89
24.0	32.0	13.59	7.17	2.42	12.65	6.79	2.98	11.71	6.41	3.54	11.24	6.23	3.82	9.96	5.75	3.43	8.33	5.18	2.89

Temp: Fahrenheit  
TC, SHC: kBtu/h  
PI: kW

INDOOR		OUTDOOR TEMPERATURE (°FDB)																	
EWB	EDB	50			68			86			95			104			115		
		TC	SHC	PI	TC	SHC	PI	TC	SHC	PI	TC	SHC	PI	TC	SHC	PI	TC	SHC	PI
57.2	68.0	28.42	20.01	2.21	28.42	20.01	2.90	28.42	20.01	3.46	28.42	20.01	3.74	26.40	18.95	3.43	20.83	16.13	2.89
60.8	71.6	34.90	22.36	2.30	34.90	22.36	2.92	33.62	21.68	3.48	32.02	20.84	3.75	27.92	18.77	3.43	22.35	16.12	2.89
64.4	77.0	41.61	25.74	2.37	38.41	24.06	2.93	35.20	22.45	3.49	33.60	21.66	3.77	29.43	19.69	3.43	23.86	17.21	2.89
67.0	80.0	42.40	26.57	2.38	39.20	24.95	2.94	35.99	23.39	3.50	34.40	22.63	3.78	30.19	20.71	3.43	24.62	18.31	2.89
71.6	86.0	44.78	25.36	2.41	41.57	23.92	2.97	38.37	22.53	3.53	36.77	21.86	3.81	32.46	20.10	3.43	26.89	17.97	2.89
75.2	89.6	46.36	24.47	2.42	43.16	23.15	2.98	39.96	21.88	3.54	38.35	21.26	3.82	33.98	19.63	3.43	28.41	17.67	2.89

Heating

AFR	27.2
-----	------

Temp: Celsius  
TC, PI: kW

INDOOR		OUTDOOR TEMPERATURE (°CWB)													
EDB	°C	-15		-10		-5		0		6		10		18	
		TC	PI	TC	PI	TC	PI	TC	PI	TC	PI	TC	PI	TC	PI
15.0	5.03	2.75	6.04	2.89	7.06	3.03	8.07	3.17	10.92	3.71	11.88	3.84	13.79	4.09	
21.1	4.72	2.83	5.73	2.97	6.75	3.11	7.76	3.25	10.56	3.80	11.51	3.92	13.42	4.17	
22.0	4.60	2.86	5.61	3.00	6.62	3.14	7.64	3.28	10.41	3.83	11.37	3.96	13.28	4.21	
24.0	4.47	2.89	5.48	3.03	6.50	3.17	7.51	3.31	10.27	3.87	11.22	3.99	13.13	4.24	
25.0	4.41	2.90	5.42	3.05	6.44	3.19	7.45	3.33	10.20	3.88	11.15	4.01	13.06	4.26	
27.0	4.29	2.94	5.30	3.08	6.31	3.22	7.33	3.36	10.05	3.92	11.00	4.04	12.91	4.29	

Temp: Fahrenheit  
TC: kBtu/h  
PI: kW

INDOOR		OUTDOOR TEMPERATURE (°FWB)													
EDB	°F	5		14		23		32		43		50		64	
		TC	PI	TC	PI	TC	PI	TC	PI	TC	PI	TC	PI	TC	PI
59.0	17.16	2.75	20.62	2.89	24.08	3.03	27.53	3.17	37.27	3.71	40.53	3.84	47.04	4.09	
70.0	16.10	2.83	19.56	2.97	23.02	3.11	26.48	3.25	36.00	3.80	39.29	3.92	45.80	4.17	
71.6	15.68	2.86	19.14	3.00	22.60	3.14	26.05	3.28	35.53	3.83	38.79	3.96	45.30	4.21	
75.2	15.26	2.89	18.71	3.03	22.17	3.17	25.63	3.31	35.04	3.87	38.29	3.99	44.80	4.24	
77.0	15.04	2.90	18.50	3.05	21.96	3.19	25.42	3.33	34.79	3.88	38.04	4.01	44.55	4.26	
80.6	14.62	2.94	18.08	3.08	21.54	3.22	25.00	3.36	34.29	3.92	37.54	4.04	44.05	4.29	

**Symbols:**

AFR	: Airflow rate	(m <sup>3</sup> /min.)
BF	: Bypass factor	
EWB	: Entering wet bulb temp.	(°C) / (°F)
EDB	: Entering dry bulb temp.	(°C) / (°F)
TC	: Total capacity	(kW) / (kBtu/h)
SHC	: Sensible heat capacity	(kW) / (kBtu/h)
PI	: Power input	(kW)

**Notes:**

1. ■ shows nominal (rated) capacities and power input.
2. TC, PI and SHC must be calculated by interpolation using the figures in the above tables. (Figures out of the tables should not be used for calculation.)
3. Capacities are based on the following conditions.  
Corresponding refrigerant piping length : 25 ft (7.5 m)  
Level difference : 0 ft (0 m)
4. Airflow rate (AFR) and bypass factor (BF) are tabulated above table.

3D108102

### 7.3 Capacity Correction Factor by the Length of Refrigerant Piping (Reference)

The cooling capacity and the heating capacity of the unit have to be corrected in accordance with the length of refrigerant piping — the distance between the indoor unit and the outdoor unit.

<— line : cooling capacity>

<--- line : heating capacity>

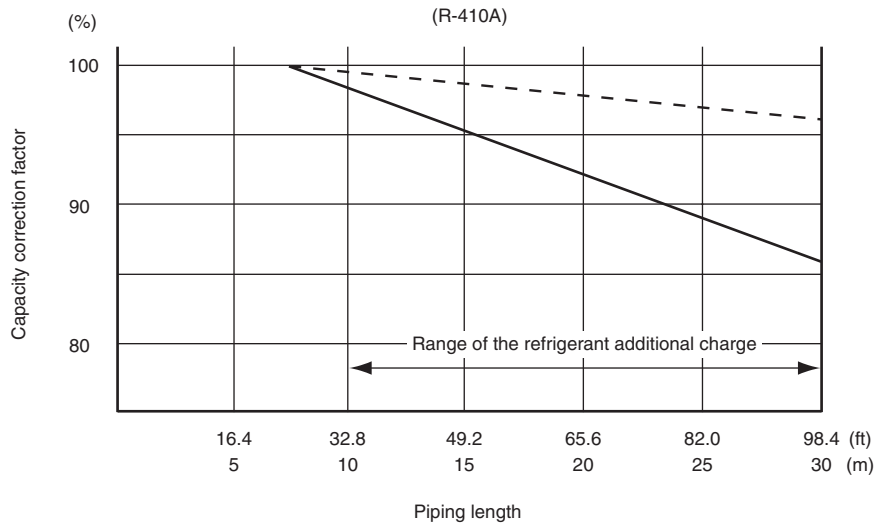

**Note:** The graph shows the factor when additional refrigerant of the proper quantity is charged.

# 8. Operation Limit

## RK30/36NMVJU

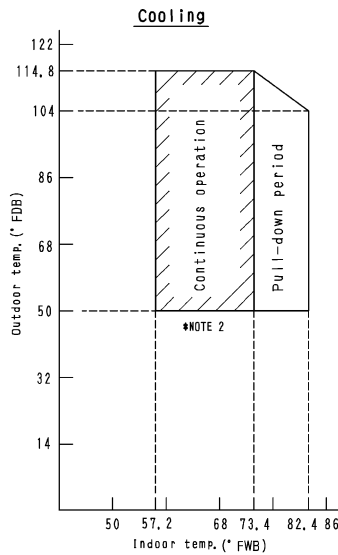

Notes:  
 1, The graphs are based on the following conditions,  
 - Equivalent piping length 25ft  
 - Level difference 0ft  
 - Air flow rate High  
 2, Facility Setting (cooling at low outdoor temperature)  
 This function is limited only for facilities (the target of air conditioning is equipment such as computer).  
 Never use it in a residence or office (the space where is a human).  
 Refer to the installation manual in detail of setting.

4D108219

## RX30/36NMVJU

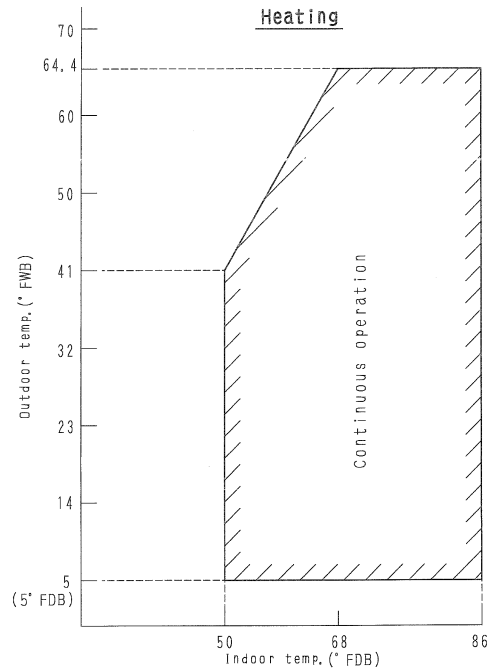
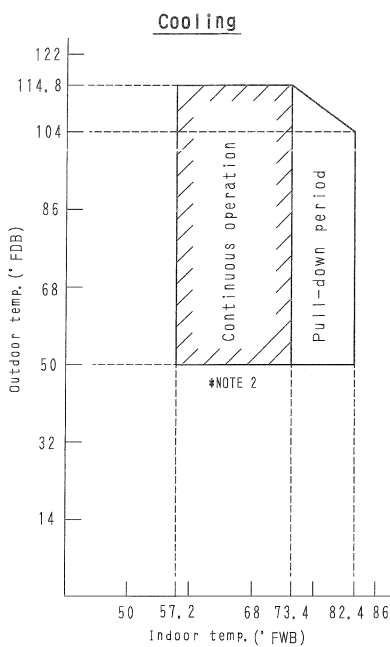

Notes:  
 1, The graphs are based on the following conditions,  
 - Equivalent piping length 25ft  
 - Level difference 0ft  
 - Air flow rate High  
 2, Facility Setting (cooling at low outdoor temperature)  
 This function is limited only for facilities (the target of air conditioning is equipment such as computer).  
 Never use it in a residence or office (the space where is a human).  
 Refer to the installation manual in detail of setting.

3D108218

# 9. Sound Level

## 9.1 Measuring Location

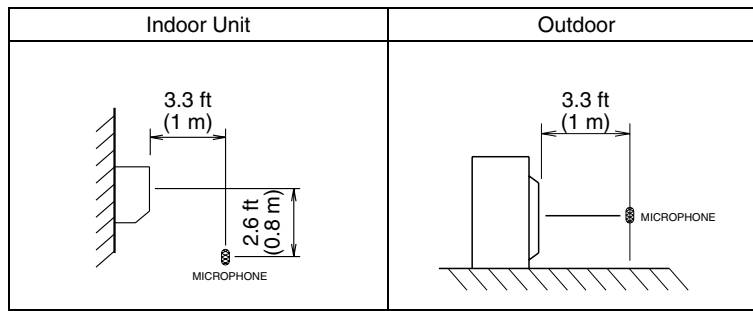

- Notes:**
1. Operation sound is measured in an anechoic chamber.
  2. The operation sound measuring method is based on JIS standard.

## 9.2 Indoor Unit

### FTX30NVJU

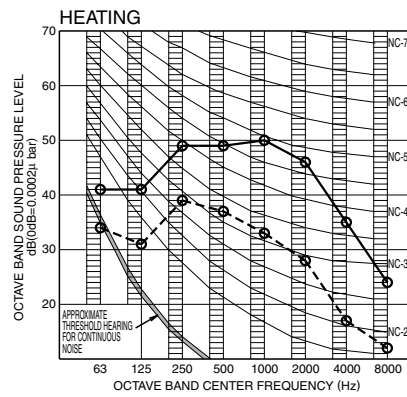
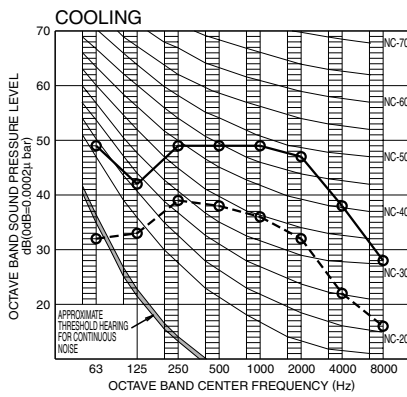

3D108154

### FTX36NVJU

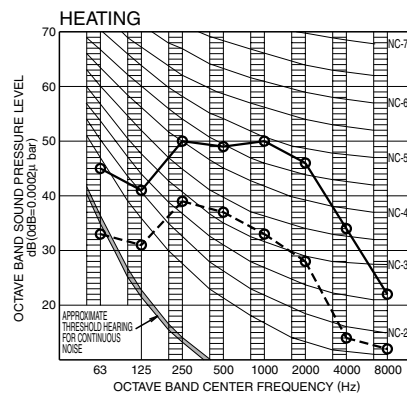
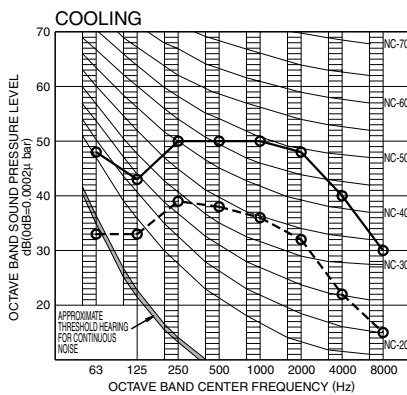

C: 3D108155

### 9.3 Outdoor Unit

#### 9.3.1 Cooling Only

##### RK30NMVJU

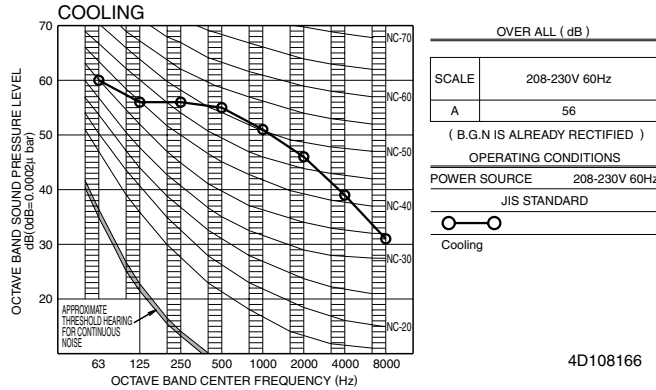

##### RK36NMVJU

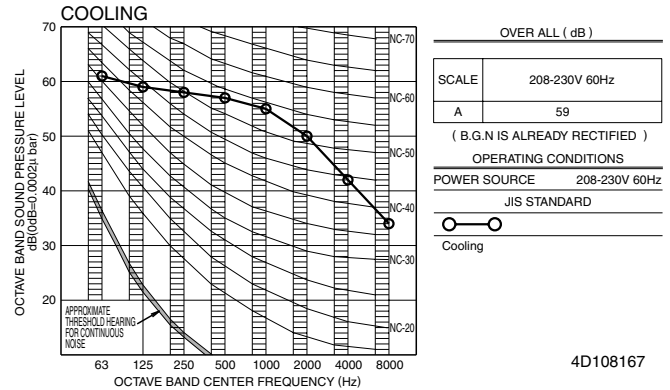

#### 9.3.2 Heat Pump

##### RX30NMVJU

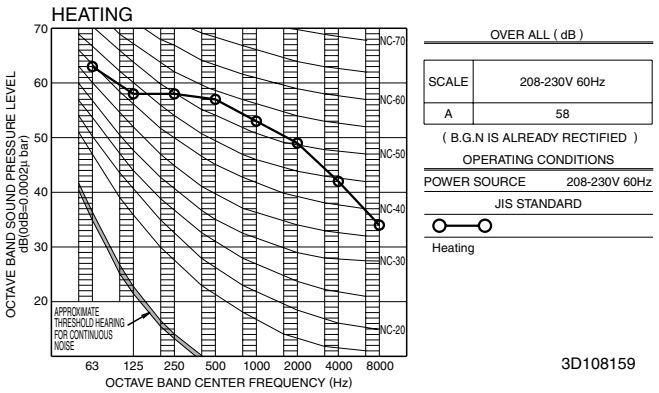
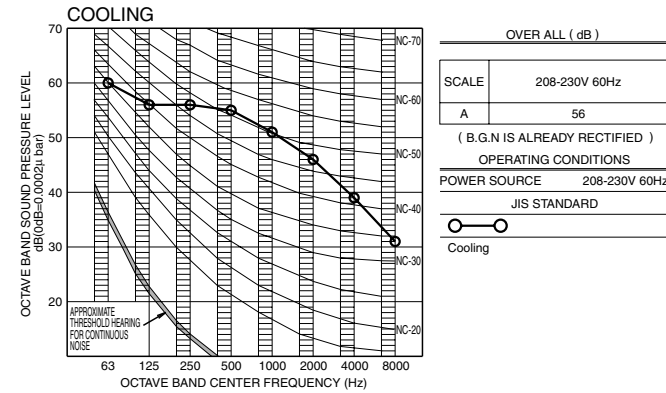

##### RX36NMVJU

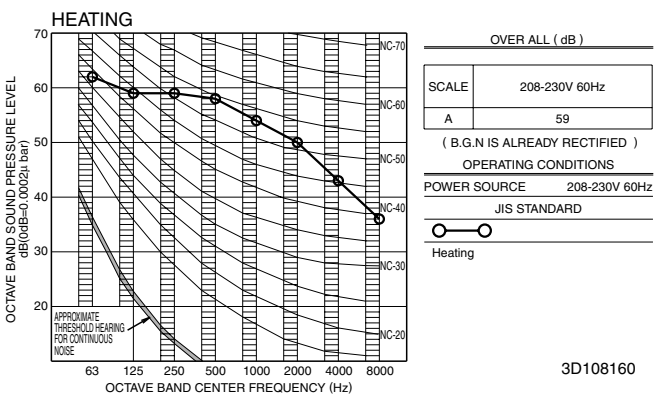
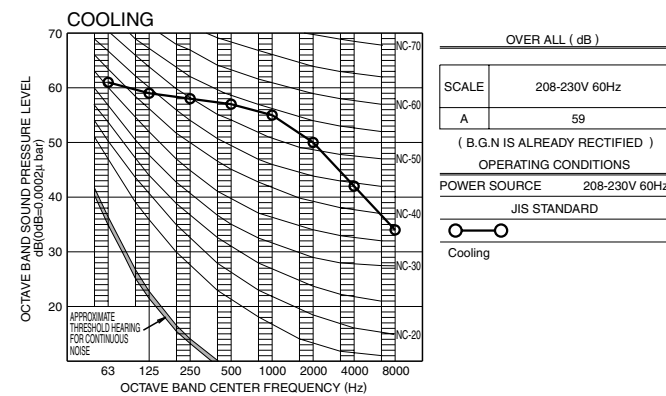

## 10. Electric Characteristics

Unit Combination		Power Supply				Compressor	OFM		IFM	
Indoor Unit	Outdoor Unit	Hz - Volts	Voltage Range	MCA	MFA	RLA	W	FLA	W	FLA
FTX30NVJU	RK30NMVJU	60 - 208	MAX. 60 Hz, 253 V MIN. 60 Hz, 187 V	17	20	16.25	93	0.62	64	0.37
		60 - 230								
FTX36NVJU	RK36NMVJU	60 - 208	MAX. 60 Hz, 253 V MIN. 60 Hz, 187 V	17	20	16.25	123	0.83	64	0.37
		60 - 230								
FTX30NVJU	RX30NMVJU	60 - 208	MAX. 60 Hz, 253 V MIN. 60 Hz, 187 V	19.8	20	18.25	93	0.62	64	0.37
		60 - 230								
FTX36NVJU	RX36NMVJU	60 - 208	MAX. 60 Hz, 253 V MIN. 60 Hz, 187 V	19.8	20	18.25	123	0.83	64	0.37
		60 - 230								

### Symbols:

MCA	: Min. circuit amps (A)
MFA	: Max. fuse amps (A)
RLA	: Rated load amps (A)
OFM	: Outdoor fan motor
IFM	: Indoor fan motor
W	: Fan motor rated output (W)
FLA	: Full load amps (A)

### Notes:

1. RLA is the max current that comes in cooling operation and heating operation.
2. Maximum allowable voltage variation between phases is 2%.
3. Select wire size based on the larger value of MCA.
4. Instead of a fuse, use a circuit breaker.
5. Be sure to install a ground leak detector.  
(This unit uses an inverter, which means that a ground leak detector capable of handling high harmonics must be used in order to prevent malfunctioning of the ground leak detector.)

3D108105

# 11. Installation Manual

## 11.1 Indoor Unit

# Contents

<b>Safety Considerations .....</b>	<b>1</b>	<b>Refrigerant Piping Work .....</b>	<b>8</b>
<b>Accessories .....</b>	<b>3</b>	1. Flaring the pipe end .....	8
<b>Choosing an Installation Site .....</b>	<b>3</b>	2. Refrigerant piping.....	8
1. Indoor unit.....	3	<b>Installation Tips .....</b>	<b>9</b>
2. Wireless remote controller .....	3	1. Removing and installing the front panel.....	9
<b>Indoor Unit Installation Diagram .....</b>	<b>4</b>	2. Removing and installing the front grille.....	9
<b>Indoor Unit Installation .....</b>	<b>5</b>	3. How to set the different addresses .....	9
1. Installing the mounting plate .....	5	4. When connecting to an HA system.....	9
2. Drilling a wall hole and installing wall embedded pipe ...	5	<b>Trial Operation and Testing .....</b>	<b>10</b>
3. Installing the indoor unit.....	5	1. Trial operation and testing .....	10
4. Wiring.....	6	2. Test items .....	10
5. Drain piping.....	7		





# Safety Considerations

Read these **Safety Considerations for Installation** carefully before installing an air conditioner or heat pump. After completing the installation, make sure that the unit operates properly during the startup operation.

Instruct the user on how to operate and maintain the unit. Inform users that they should store this installation manual with the operation manual for future reference.

Always use a licensed installer or contractor to install this product. Improper installation can result in water or refrigerant leakage, electric shock, fire, or explosion.

Meanings of **DANGER**, **WARNING**, **CAUTION**, and **NOTE** Symbols:

-  **DANGER** .....Indicates an imminently hazardous situation which, if not avoided, will result in death or serious injury.
-  **WARNING** .....Indicates a potentially hazardous situation which, if not avoided, could result in death or serious injury.
-  **CAUTION** .....Indicates a potentially hazardous situation which, if not avoided, may result in minor or moderate injury. It may also be used to alert against unsafe practices.
-  **NOTE** .....Indicates situations that may result in equipment or property-damage accidents only.

-  **DANGER** .....
- Refrigerant gas is heavier than air and replaces oxygen. A massive leak can lead to oxygen depletion, especially in basements, and an asphyxiation hazard could occur leading to serious injury or death.
- Do not ground units to water pipes, gas pipes, telephone wires, or lightning rods as incomplete grounding can cause a severe shock hazard resulting in severe injury or death. Additionally, grounding to gas pipes could cause a gas leak and potential explosion causing severe injury or death.









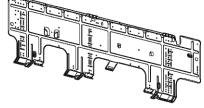

- If refrigerant gas leaks during installation, ventilate the area immediately. Refrigerant gas may produce toxic gas if it comes into contact with fire. Exposure to this gas could cause severe injury or death.
- After completing the installation work, check that the refrigerant gas does not leak throughout the system.
- Do not install unit in an area where flammable materials are present due to risk of explosions that can cause serious injury or death.
- Safely dispose all packing and transportation materials in accordance with federal/state/local laws or ordinances. Packing materials such as nails and other metal or wood parts, including plastic packing materials used for transportation may cause injuries or death by suffocation.

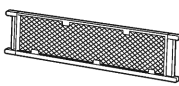
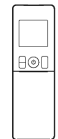
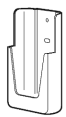
-  **WARNING** .....
- Only qualified personnel must carry out the installation work. Installation must be done in accordance with this installation manual. Improper installation may result in water leakage, electric shock, or fire.
- When installing the unit in a small room, take measures to keep the refrigerant concentration from exceeding allowable safety limits. Excessive refrigerant leaks, in the event of an accident in a closed ambient space, can lead to oxygen deficiency.
- Use only specified accessories and parts for installation work. Failure to use specified parts may result in water leakage, electric shock, fire, or the unit falling.
- Install the air conditioner or heat pump on a foundation strong enough that it can withstand the weight of the unit. A foundation of insufficient strength may result in the unit falling and causing injuries.
- Take into account strong winds, typhoons, or earthquakes when installing. Improper installation may result in the unit falling and causing accidents.

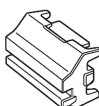

- Make sure that a separate power supply circuit is provided for this unit and that all electrical work is carried out by qualified personnel according to local, state, and national regulations. An insufficient power supply capacity or improper electrical construction may lead to electric shock or fire.
  - Make sure that all wiring is secured, that specified wires are used, and that no external forces act on the terminal connections or wires. Improper connections or installation may result in fire.
  - When wiring, position the wires so that the electrical wiring box cover can be securely fastened. Improper positioning of the electrical wiring box cover may result in electric shock, fire, or the terminals overheating.
  - Before touching electrical parts, turn off the unit.
  - The circuit must be protected with safety devices in accordance with local and national codes, i.e. a fuse, a circuit breaker, a disconnect or a GFCI.
  - Securely fasten the outdoor unit terminal cover (panel). If the terminal cover/panel is not installed properly, dust or water may enter the outdoor unit causing fire or electric shock.
  - When installing or relocating the system, keep the refrigerant circuit free from substances other than the specified refrigerant (R410A) such as air. Any presence of air or other foreign substance in the refrigerant circuit can cause an abnormal pressure rise or rupture, resulting in injury.
  - Do not change the setting of the protection devices. If the pressure switch, thermal switch, or other protection device is shorted and operated forcibly, or parts other than those specified by Daikin are used, fire or explosion may occur.
- ⚠ CAUTION**
- Do not touch the switch with wet fingers. Touching a switch with wet fingers can cause electric shock.
  - Do not allow children to play on or around the unit to prevent injury.
  - The heat exchanger fins are sharp enough to cut. To avoid injury wear gloves or cover the fins while working around them.
  - Do not touch the refrigerant pipes during and immediately after operation as the refrigerant pipes may be hot or cold, depending on the condition of the refrigerant flowing through the refrigerant piping, compressor, and other refrigerant cycle parts. Your hands may suffer burns or frostbite if you touch the refrigerant pipes. To avoid injury, give the pipes time to return to normal temperature or, if you must touch them, be sure to wear proper gloves.
  - Install drain piping to proper drainage. Improper drain piping may result in water leakage and property damage.
  - Insulate piping to prevent condensation.
  - Be careful when transporting the product.
  - Do not turn off the power immediately after stopping operation. Always wait for at least 5 minutes before turning off the power. Otherwise, water leakage may occur.
  - Do not use a charging cylinder. Using a charging cylinder may cause the refrigerant to deteriorate.
  - Refrigerant R410A in the system must be kept clean, dry, and tight.
    - (a) Clean and Dry -- Foreign materials (including mineral oils such as SUNISO oil or moisture) should be prevented from getting into the system.
    - (b) Tight -- R410A does not contain any chlorine, does not destroy the ozone layer, and does not reduce the earth's protection against harmful ultraviolet radiation. R410A can contribute to the greenhouse effect if it is released. Therefore take proper measures to check for the tightness of the refrigerant piping installation. Read the chapter *Refrigerant Piping Work* and follow the procedures.
- Since R410A is a blend, the required additional refrigerant must be charged in its liquid state. If the refrigerant is charged in a state of gas, its composition can change and the system will not work properly.
  - The indoor unit is for R410A. See the catalog for indoor models that can be connected. Normal operation is not possible when connected to other units.
  - Remote controller (wireless kit) transmitting distance can be shorter than expected in rooms with electronic fluorescent lamps (inverter or rapid start types). Install the indoor unit far away from fluorescent lamps as much as possible.
  - Indoor units are for indoor installation only. Outdoor units can be installed either outdoors or indoors. This unit is for indoor use.
  - Do not install the air conditioner or heat pump in the following locations:
    - (a) Where a mineral oil mist or oil spray or vapor is produced, for example, in a kitchen. Plastic parts may deteriorate and fall off or result in water leakage.
    - (b) Where corrosive gas, such as sulfurous acid gas, is produced. Corroding copper pipes or soldered parts may result in refrigerant leakage.
    - (c) Near machinery emitting electromagnetic waves. Electromagnetic waves may disturb the operation of the control system and cause the unit to malfunction.
    - (d) Where flammable gas may leak, where there is carbon fiber, or ignitable dust suspension in the air, or where volatile flammables such as thinner or gasoline are handled. Operating the unit in such conditions can cause a fire.
  - Take adequate measures to prevent the outdoor unit from being used as a shelter by small animals. Small animals making contact with electrical parts can cause malfunctions, smoke, or fire. Instruct the user to keep the area around the unit clean.
- ⚠ NOTE**
- The indoor unit should be positioned where the unit and inter-unit wires (outdoor to indoor) are at least 3.3ft (1m) away from any televisions or radios. (The unit may cause interference with the picture or sound.) Depending on the radio waves, a distance of 3.3ft (1m) may not be sufficient to eliminate the noise.
  - Dismantling the unit, treatment of the refrigerant, oil and additional parts must be done in accordance with the relevant local, state, and national regulations.
  - Do not use the following tools that are used with conventional refrigerants: gauge manifold, charge hose, gas leak detector, reverse flow check valve, refrigerant charge base, vacuum gauge, or refrigerant recovery equipment.
  - If the conventional refrigerant and refrigerator oil are mixed in R410A, the refrigerant may deteriorate.
  - This air conditioner or heat pump is an appliance that should not be accessible to the general public.
  - As design pressure is 604 psi, the wall thickness of field-installed pipes should be selected in accordance with the relevant local, state, and national regulations.

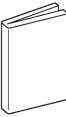
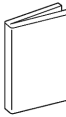
# Accessories

<p>Ⓐ Mounting plate</p> 	1	<p>Ⓑ Mounting plate fixing screw M4 × 1" (M4 × 25mm)</p> 	9	<p>Ⓒ Titanium apatite photocatalytic air-purifying filter</p> 	3
<p>Ⓓ Wireless remote controller</p> 	1	<p>Ⓔ Remote controller holder</p> 	1	<p>Ⓕ Remote controller holder fixing screw M3 × 13/16" (M3 × 20mm)</p> 	2
<p>Ⓖ Dry battery AAA. LR03 (alkaline)</p> 	2	<p>Ⓗ Indoor unit fixing screw M4 × 1/2" (M4 × 12mm)</p> 	3	<p>Ⓖ Screw cover</p> 	3
<p>Ⓚ Tube</p> 	1	<p>Ⓛ Operation manual</p> 	1	<p>Ⓜ Installation manual</p> 	1
<p>Ⓝ Warranty</p> 	1				

# Choosing an Installation Site

Before choosing the installation site, obtain user approval.

## 1. Indoor unit

The indoor unit should be positioned in a place where:

- 1) the restrictions on the installation requirements specified in “Indoor Unit Installation Diagram” on page 4 are met,
- 2) both the air inlet and air outlet are unobstructed,
- 3) the unit is not exposed to direct sunlight,
- 4) the unit is away from sources of heat or steam,
- 5) there is no source of machine oil vapor (this may shorten the indoor unit service life),
- 6) cool/warm air is circulated throughout the room,
- 7) the unit is away from electronic ignition type fluorescent lamps (inverter or rapid start type) as they may affect the remote controller range,
- 8) no laundry equipment is nearby.

## 2. Wireless remote controller

- 1) Turn on all the fluorescent lamps in the room, if any, and find a location where the remote controller signals are properly received by the indoor unit (within 23ft (7m)).
- 2) Configure the jumper. Configure according to the type of unit (heat pump or cooling only) the user purchased. The default setting is heat pump.
  - **For heat pump (outdoor unit model: RX)**  
No change to jumper setting is required.
  - **For cooling only (outdoor unit model: RK)**  
Cut the address jumper (J8) inside the remote controller.

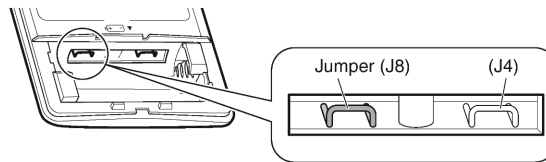

# Indoor Unit Installation Diagram

## ⚠ CAUTION

- Do not hit or violently push the INTELLIGENT EYE sensor. This can lead to damage and malfunction.
- Do not place large objects near the INTELLIGENT EYE sensor. Also keep heating units or humidifiers outside the sensor's detection area.

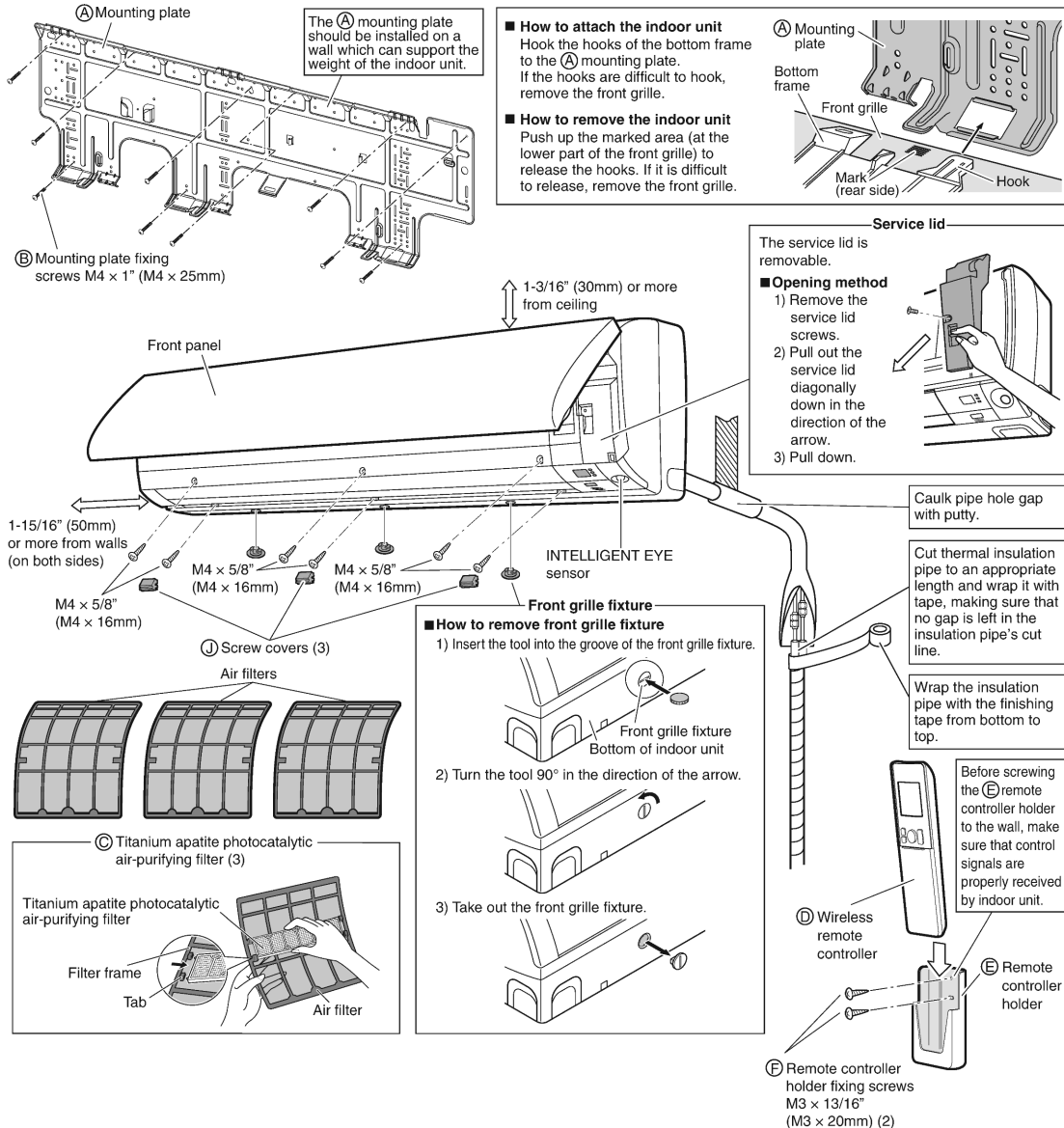

# Indoor Unit Installation

## 1. Installing the mounting plate

The mounting plate should be installed on a wall which can support the weight of the indoor unit.

- 1) Temporarily secure the mounting plate to the wall, make sure that the plate is completely level, and mark the drilling points on the wall.
- 2) Secure the mounting plate to the wall with screws.

### Recommended mounting plate retention spots and dimensions

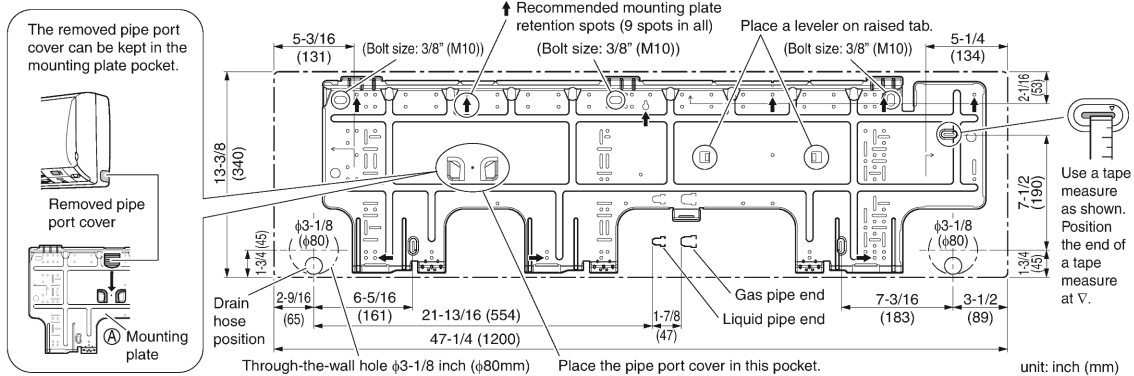

## 2. Drilling a wall hole and installing wall embedded pipe

### ⚠ WARNING

For metal frame or metal board walls, be sure to use a wall embedded pipe and wall hole cover in the feed-through hole to prevent possible heat, electric shock, or fire.

- Be sure to caulk the gaps around the pipes with caulking material to prevent condensation.
  - 1) Drill a feed-through hole with a  $\phi 3-1/8$  inch (80mm) diameter through the wall at a downward angle toward the outside.
  - 2) Insert a wall embedded pipe into the hole.
  - 3) Insert a wall hole cover into wall pipe.
  - 4) After completing refrigerant piping, wiring, and drain piping, caulk the pipe hole gap with putty.

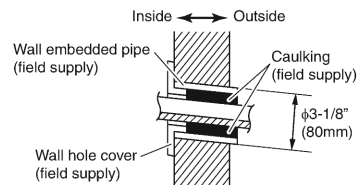

## 3. Installing the indoor unit

### 3-1. Right-side, right-back, or right-bottom piping

- 1) Attach the drain hose to the underside of the refrigerant pipes with adhesive vinyl tape.
- 2) Wrap the refrigerant pipes and drain hose together with an insulation tape.
- 3) Pass the drain hose and refrigerant pipes through the wall hole, then position the indoor unit on the (A) mounting plate hooks, using the  $\Delta$  markings at the top of the indoor unit as a guide.
- 4) Open the front panel, then open the service lid. (Refer to "Service lid" on page 4.)
- 5) Pass the inter-unit wire from the outdoor unit through the feed-through wall hole and then through the back of the indoor unit. Pull them through the front side. Bend the ends of tie wires upward for easier work in advance. (If the inter-unit wire ends are to be stripped first, bundle wire ends with adhesive tape.)
- 6) Press the bottom frame of the indoor unit with both hands until it is firmly caught by the (A) mounting plate hooks. Make sure that the wires do not catch on the edge of the indoor unit.

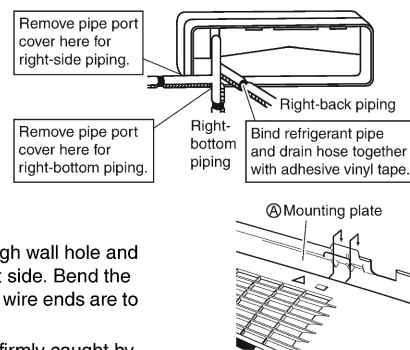

### 3-2. Left-side, left-back, or left-bottom piping

**How to switch around the drain plug and drain hose**

1) Remove the fixing screw and pull out the drain hose.

3) Switch around the drain hose and drain plug.

Push the drain plug all the way in using a hexagonal wrench (3/16 inch (4mm)).

Do not apply lubricating oil (refrigerant oil) to the drain plug when inserting it. The application of lubrication oil to the drain plug will deteriorate the plug to cause drain leakage from the plug.

Insert drain hose securely and fix in place with fixing screw.

- 1) Switch around the drain plug and drain hose.
- 2) Attach the drain hose to the underside of the refrigerant pipes with adhesive vinyl tape.
- 3) Shape the refrigerant pipes along the pipe path marking on the (A) mounting plate.
- 4) Pass the drain hose and refrigerant pipes through the wall hole, then position the indoor unit on the (A) mounting plate hooks, using the Δ markings at the top of the indoor unit as a guide.
- 5) Open the front panel, then open the service lid. (Refer to "Service lid" on page 4.)
- 6) Pass the inter-unit wire from the outdoor unit through the feed-through wall hole and then through the back of the indoor unit. Pull them through the front side. Bend the ends of tie wires upward for easier work in advance. (If the inter-unit wire ends are to be stripped first, bundle wire ends with adhesive tape.)
- 7) Connect the refrigerant pipes.
- 8) In case of pulling the drain hose through the back of the indoor unit, wrap the refrigerant pipes and drain hose together with insulation tape as shown in the figure.
- 9) Press the bottom frame of the indoor unit with both hands until it is firmly caught by the (A) mounting plate hooks. Make sure that the wires do not catch on the edge of the indoor unit.

Remove pipe port cover here for left-side piping.

Remove pipe port cover here for left-back piping.

Remove pipe port cover here for left-bottom piping.

Caulk this hole with putty or caulking material.

Bind with adhesive vinyl tape.

Wrap insulation tape around the bent portion of refrigerant pipe. Overlap at least half the width of the insulation tape with each turn.

Secure the indoor unit to the (A) mounting plate with the (B) indoor unit fixing screws M4 × 1/2" (M4 × 12mm)(3 point).

### 3-3. Wall embedded piping

Follow the instructions given under

#### Left-side, left-back, or left-bottom piping

- 1) Insert the drain hose to this depth so it won't be pulled out of the drain pipe.

Insert the drain hose to this depth so it won't be pulled out of the drain pipe.

1-15/16" (50mm) or more

φ1-3/16" (30mm) or more

## 4. Wiring

Refer to the installation manual for the outdoor unit also.

### ! WARNING

- Do not use tapped wires, extension cords, or starburst connections, as they may cause overheating, electric shock, or fire.
- Do not use locally purchased electrical parts inside the product. (Do not branch the power for the drain pump, etc., from the terminal block.) Doing so may cause electric shock or fire.
- Do not connect the power wire to the indoor unit. Doing so may cause electric shock or fire.

# Indoor Unit Installation

## ⚠ CAUTION

When connecting the connection wire to the terminal block using a single core wire, be sure to perform curling. Problems with the installation may cause heat and fires.

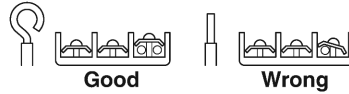

- 1) As shown in the illustration on the right-hand side, insert the wires including the ground wire into the conduit and secure them with lock nut onto the conduit mounting plate.
- 2) Insert the wires including the ground wire into (K) tube.
- 3) Strip wire ends (9/16 inch (15mm)).
- 4) Match wire colors with terminal numbers on indoor and outdoor unit's terminal blocks and firmly screw wires to the corresponding terminals.
- 5) Connect the ground wires to the corresponding terminals.
- 6) Pull the wires and check that the wires are securely fixed to the terminal block.
- 7) In case of connecting to an adapter system, run the remote controller cable and attach the S21.  
(Refer to "4. When connecting to an HA system" on page 9.)
- 8) Shape the wires so that the service lid fits securely, then close service lid.

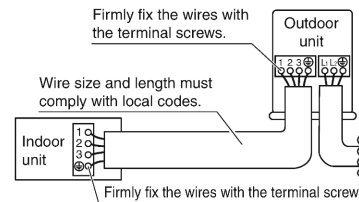
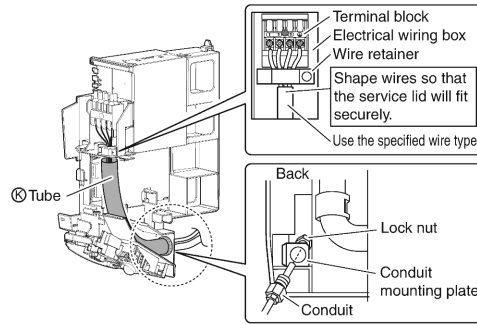

## 5. Drain piping

- 1) Connect the drain hose, as described on the right.
- 2) Remove the air filters and pour some water into the drain pan to check the water flows smoothly.
- 3) If drain hose extension or embedded drain piping is required, use appropriate parts that match the hose front end.

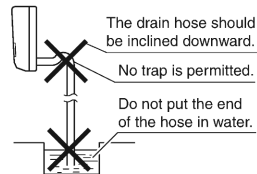
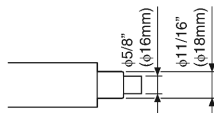
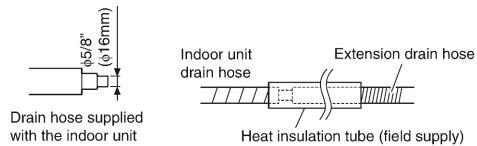

Figure of hose front end



- When drain hose requires extension, obtain an extension hose with an inner diameter of 5/8 inch (16mm). Be sure to thermally insulate the indoor section of the extension hose.



- When connecting a rigid polyvinyl chloride pipe (nominal diameter 1/2 inch (13mm)) directly to the drain hose attached to the indoor unit as with embedded piping work, use any commercially available drain socket (nominal diameter 1/2 inch (13mm)) as a joint.

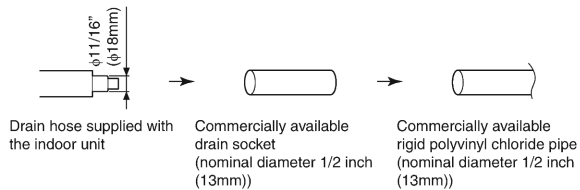

# Refrigerant Piping Work

## ⚠ WARNING

- Do not apply mineral oil on flared part.
- Prevent mineral oil from getting into the system as this would reduce the service life of the units.
- Never use piping which has been used for previous installations. Only use parts which are delivered with the unit.
- Never install a dryer to this R410A unit in order to guarantee its service life.
- The drying material may dissolve and damage the system.
- Incomplete flaring may result in refrigerant gas leakage.

## 1. Flaring the pipe end

- 1) Cut the pipe end with a pipe cutter.
- 2) Remove burrs with the cut surface facing downward so that the filings do not enter the pipe.



- 3) Put the flare nut on the pipe.
- 4) Flare the pipe.
- 5) Check that the flaring has been done correctly.

Flaring

Set exactly at the position shown below.

Flare tool for R410A	Conventional flare tool	
	Clutch-type	Clutch-type (Rigid-type) / Wing-nut type (Imperial-type)
A	0-0.020 inch (0-0.5mm)	0.039-0.059 inch (1.0-1.5mm) / 0.059-0.079 inch (1.5-2.0mm)

Check

The flare's inner surface must be flaw-free.

The pipe end must be evenly flared in a perfect circle.

Make sure that the flare nut is fitted.

## 2. Refrigerant piping

### ⚠ CAUTION

- Use the flare nut fixed to the main unit. (This is to prevent the flare nut from cracking as a result of deterioration over time.)
- To prevent gas leakage, apply refrigeration oil only to the inner surface of the flare. (Use refrigeration oil for R410A.)
- Use a torque wrench when tightening the flare nuts to prevent damage to the flare nuts and gas leakage.

- Align the centers of both flares and tighten the flare nuts 3 or 4 turns by hand, then tighten them fully with a spanner and a torque wrench.

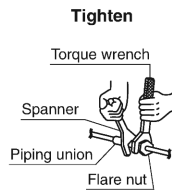
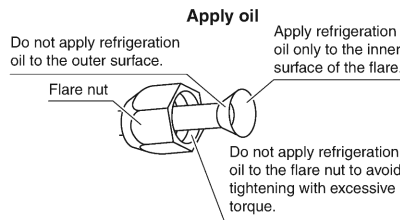

	Piping size	Flare nut tightening torque
Gas side	O.D. 5/8 inch (15.9mm)	45-5/8-55-5/8ft • lbf (61.8-75.4N • m)
Liquid side	O.D. 1/4 inch (6.4mm)	10-1/2-12-3/4ft • lbf (14.2-17.2N • m)

### 2-1. Caution on piping handling

- Protect the open end of the pipe against dust and moisture.
- All pipe bends should be as gentle as possible. Use a pipe bender for bending.

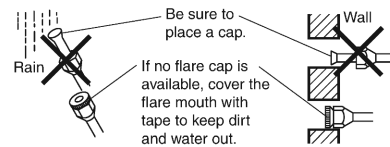

### 2-2. Selection of copper and heat insulation materials

When using commercial copper pipes and fittings, observe the following:

- Insulation material: Polyethylene foam  
Heat transfer rate: 0.041 to 0.052W/mK (0.024 to 0.030Btu/ft<sup>2</sup>h°F (0.035 to 0.045kcal/mh°C))  
Be sure to use insulation that is designed for use with HVAC Systems.
- ACR Copper only.
- Be sure to insulate both the gas and liquid piping and observe the insulation dimensions as below.

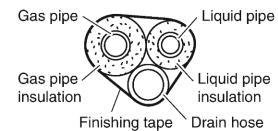

	Piping size	Minimum bend radius	Piping thickness	Thermal insulation size	Thermal insulation thickness
Gas side	O.D. 5/8 inch (15.9mm)	1-15/16 inch (50mm) or more	0.039 inch (1.0mm) (C1220T-O)	I.D. 5/8-13/16 inch (16-20mm)	13/32 inch (10mm) Min.
Liquid side	O.D. 1/4 inch (6.4mm)	1-3/16 inch (30mm) or more	0.031 inch (0.8mm) (C1220T-O)	I.D. 5/16-13/32 inch (8-10mm)	

- Use separate thermal insulation pipes for gas and liquid refrigerant pipes.

# Installation Tips

## 1. Removing and installing the front panel

**• Removal method**

- 1) Grip the panel tabs on each side of the front panel and open.
- 2) Slide the front panel to either the left or right and pull it toward you to disengage one of the front panel shafts.
- 3) Disengage the front panel shaft on the other side in the same manner.
- 4) After disengaging both front panel shafts, pull the front panel toward yourself and remove it.

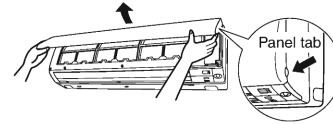

**• Installation method**

- Align the front panel shaft of the front panel with the grooves of grille, and push all the way in, then close slowly.  
Push the center of the lower panel surface firmly to engage the tabs.

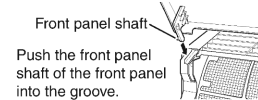

## 2. Removing and installing the front grille

**• Removal method**

- 1) Remove the front panel and air filters.
- 2) Remove 6 screws from the front grille.
- 3) Remove 3 front grille fixtures from the front grille.
- 4) In front of the ○○○ mark on the front grille, there are 4 upper hooks. Lightly pull the front grille toward you with one hand, and push down on the hooks with the fingers of your other hand.

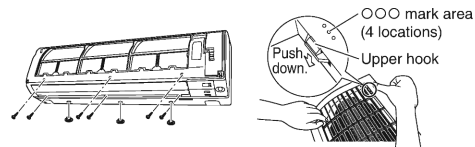

**When there is insufficient work space because the unit is close to ceiling**

Place both hands under the center of the front grille, and while pushing up, pull it toward you.

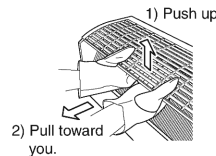

**CAUTION**  
Be sure to wear protection gloves.

**• Installation method**

- 1) Install the front grille and firmly engage the upper hooks (4 locations).
- 2) Install 6 screws of the front grille.
- 3) Install 3 front grille fixtures of the front grille.
- 4) Install the air filters and then mount the front panel.

## 3. How to set the different addresses

When 2 indoor units are installed in one room, the 2 wireless remote controllers can be set for different addresses. Change the address setting of one of the 2 units. When cutting the jumper, be careful not to damage any of the surrounding parts.

- 1) Remove the front grille. (6 screws, 3 front grille fixtures)
- 2) Remove the metal plate electrical wiring box cover. (4 tabs) (See Fig.1)
- 3) Cut the address jumper (JA) on the printed circuit board. (See Fig.2)
- 4) Cut the address jumper (J4) in the remote controller. (See Fig.3)
  - Do not cut jumper (J8). (Jumper (J8) is cut to switch over the system to cooling only.)
- 5) Replace the metal electrical wiring box cover.
- 6) Replace the front grille.

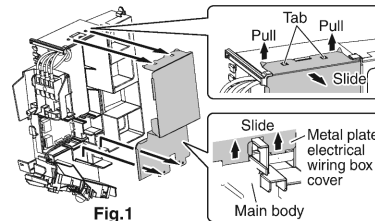

JA	ADDRESS
EXIST	1
CUT	2

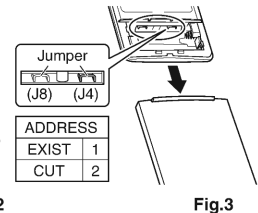
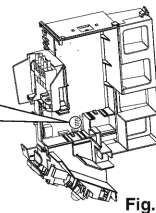

## 4. When connecting to an HA system

- 1) Remove the front grille. (6 screws, 3 front grille fixtures)
- 2) Remove the metal plate electrical wiring box cover. (4 tabs) (See Fig.1)
- 3) Attach the connection cord to the S21 connector and pull the harness out through the notched part in the figure. (See Fig.4)
- 4) Replace the electrical wiring box cover as it was, and pull the harness around, as shown in the figure. (See Fig.5)
- 5) Replace the front grille.

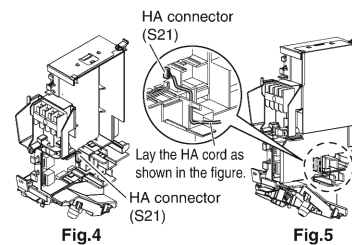









# Trial Operation and Testing

## 1. Trial operation and testing

- Trial operation should be carried out in either COOL or HEAT operation.
- 1-1. Measure the supply voltage and make sure that it is within the specified range.**
- 1-2. In COOL operation, select the lowest programmable temperature; in HEAT operation, select the highest programmable temperature.**
- 1-3. Carry out the trial operation following the instructions in the operation manual to ensure that all functions and parts, such as the movement of the louvers, are working properly.**
  - To protect the air conditioner, restart operation is disabled for 3 minutes after the system has been turned off.
- 1-4. After trial operation is complete, set the temperature to a normal level (78°F to 82°F (26°C to 28°C) in COOL operation, 68°F to 75°F (20°C to 24°C) in HEAT operation).**
- When operating the air conditioner in COOL operation in winter, or HEAT operation in summer, set it to the trial operation mode using the following method.

- 1) Press  to turn on the system.
  - 2) Press both of  and  at the same time.
  - 3) Press , select “?””, and press  for confirmation.
- Trial operation will stop automatically after about 30 minutes.
  - To stop the operation, press .
  - Some of the functions cannot be used in the trial operation mode.

- The air conditioner draws a small amount of power in its standby mode. If the system is not to be used for some time after installation, shut off the circuit breaker to eliminate unnecessary power consumption.
- If the circuit breaker trips to shut off the power to the air conditioner, the system will restore the original operation mode when the circuit breaker is opened again.

## 2. Test items

Test items	Symptom	Check
Indoor and outdoor units are installed securely.	Fall, vibration, noise	
No refrigerant gas leaks.	Incomplete cooling/heating function	
Refrigerant gas and liquid pipes and indoor drain hose extension are thermally insulated.	Water leakage	
Draining line is properly installed.	Water leakage	
System is properly grounded.	Electrical leakage	
Only specified wires are used for all wiring, and all wires are connected correctly.	No operation or burn damage	
Indoor or outdoor unit's air inlet or air outlet are unobstructed.	Incomplete cooling/heating function	
Stop valves are opened.	Incomplete cooling/heating function	
Indoor unit properly receives remote controller commands.	No operation	
Remote controller jumper setting is correct for the type of unit (heat pump or cooling only).	Remote controller malfunctioning	

## 11.2 Outdoor Unit

# Contents

<b>Safety Considerations</b> .....	1	4. Refrigerant piping .....	6
<b>Accessories</b> .....	3	5. Pressure test and evacuating system.....	7
<b>Precautions for Selecting a Location</b> .....	3	6. Refilling refrigerant .....	8
<b>Precautions on Installation</b> .....	4	7. Refrigerant piping work .....	8
<b>Outdoor Unit Installation Diagram</b> .....	4	<b>Wiring</b> .....	9
<b>Installation Space Requirements</b> .....	5	<b>Facility Setting</b>	
<b>Outdoor Unit Installation</b> .....	5	<b>(cooling at low outdoor temperature)</b> .....	11
1. Installing the outdoor unit .....	5	<b>Pump Down Operation</b> .....	12
2. Drain work (only for heat pump models).....	5	<b>Trial Operation and Testing</b> .....	12
3. Flaring the pipe end.....	6	1. Trial operation and testing .....	12
		2. Test items .....	12

# Safety Considerations

Read these **Safety Considerations for Installation** carefully before installing an air conditioner or heat pump. After completing the installation, make sure that the unit operates properly during the startup operation.





Instruct the user on how to operate and maintain the unit.

Inform users that they should store this installation manual with the operation manual for future reference.

Always use a licensed installer or contractor to install this product. Improper installation can result in water or refrigerant leakage, electric shock, fire, or explosion.

Meanings of **DANGER**, **WARNING**, **CAUTION**, and **NOTE**

Symbols:

-  **DANGER** ..... Indicates an imminently hazardous situation which, if not avoided, will result in death or serious injury.
-  **WARNING** ..... Indicates a potentially hazardous situation which, if not avoided, could result in death or serious injury.
-  **CAUTION** ..... Indicates a potentially hazardous situation which, if not avoided, may result in minor or moderate injury. It may also be used to alert against unsafe practices.
-  **NOTE** ..... Indicates situations that may result in equipment or property-damage accidents only.

### **DANGER** \_\_\_\_\_

- Refrigerant gas is heavier than air and replaces oxygen. A massive leak can lead to oxygen depletion, especially in basements, and an asphyxiation hazard could occur leading to serious injury or death.
- Do not ground units to water pipes, gas pipes, telephone wires, or lightning rods as incomplete grounding can cause a severe shock hazard resulting in severe injury or death. Additionally, grounding to gas pipes could cause a gas leak and potential explosion causing severe injury or death.

- If refrigerant gas leaks during installation, ventilate the area immediately. Refrigerant gas may produce toxic gas if it comes into contact with fire. Exposure to this gas could cause severe injury or death.
- After completing the installation work, check that the refrigerant gas does not leak throughout the system.
- Do not install unit in an area where flammable materials are present due to risk of explosions that can cause serious injury or death.
- Safely dispose all packing and transportation materials in accordance with federal/state/local laws or ordinances. Packing materials such as nails and other metal or wood parts, including plastic packing materials used for transportation may cause injuries or death by suffocation.

### **WARNING** \_\_\_\_\_

- Only qualified personnel must carry out the installation work. Installation must be done in accordance with this installation manual. Improper installation may result in water leakage, electric shock, or fire.
- When installing the unit in a small room, take measures to keep the refrigerant concentration from exceeding allowable safety limits. Excessive refrigerant leaks, in the event of an accident in a closed ambient space, can lead to oxygen deficiency.
- Use only specified accessories and parts for installation work. Failure to use specified parts may result in water leakage, electric shock, fire, or the unit falling.
- Install the air conditioner or heat pump on a foundation strong enough that it can withstand the weight of the unit. A foundation of insufficient strength may result in the unit falling and causing injuries.
- Take into account strong winds, typhoons, or earthquakes when installing. Improper installation may result in the unit falling and causing accidents.

- Make sure that a separate power supply circuit is provided for this unit and that all electrical work is carried out by qualified personnel according to local, state, and national regulations. An insufficient power supply capacity or improper electrical construction may lead to electric shock or fire.
  - Make sure that all wiring is secured, that specified wires are used, and that no external forces act on the terminal connections or wires. Improper connections or installation may result in fire.
  - When wiring, position the wires so that the electrical wiring box cover can be securely fastened. Improper positioning of the electrical wiring box cover may result in electric shock, fire, or the terminals overheating.
  - Before touching electrical parts, turn off the unit.
  - The circuit must be protected with safety devices in accordance with local and national codes, i.e. a fuse, a circuit breaker, a disconnect or a GFCI.
  - Securely fasten the outdoor unit terminal cover (panel). If the terminal cover/panel is not installed properly, dust or water may enter the outdoor unit causing fire or electric shock.
  - When installing or relocating the system, keep the refrigerant circuit free from substances other than the specified refrigerant (R410A) such as air. Any presence of air or other foreign substance in the refrigerant circuit can cause an abnormal pressure rise or rupture, resulting in injury.
  - Do not change the setting of the protection devices. If the pressure switch, thermal switch, or other protection device is shorted and operated forcibly, or parts other than those specified by Daikin are used, fire or explosion may occur.
- (b) Tight -- R410A does not contain any chlorine, does not destroy the ozone layer, and does not reduce the earth's protection against harmful ultraviolet radiation. R410A can contribute to the greenhouse effect if it is released. Therefore take proper measures to check for the tightness of the refrigerant piping installation. Read the chapter *Refrigerant Piping Work* and follow the procedures.
- Since R410A is a blend, the required additional refrigerant must be charged in its liquid state. If the refrigerant is charged in a state of gas, its composition can change and the system will not work properly.
  - The indoor unit is for R410A. See the catalog for indoor models that can be connected. Normal operation is not possible when connected to other units.
  - Remote controller (wireless kit) transmitting distance can be shorter than expected in rooms with electronic fluorescent lamps (inverter or rapid start types). Install the indoor unit far away from fluorescent lamps as much as possible.
  - Indoor units are for indoor installation only. Outdoor units can be installed either outdoors or indoors. This unit is for indoor use.
  - Do not install the air conditioner or heat pump in the following locations:
    - (a) Where a mineral oil mist or oil spray or vapor is produced, for example, in a kitchen. Plastic parts may deteriorate and fall off or result in water leakage.
    - (b) Where corrosive gas, such as sulfurous acid gas, is produced. Corroding copper pipes or soldered parts may result in refrigerant leakage.
    - (c) Near machinery emitting electromagnetic waves. Electromagnetic waves may disturb the operation of the control system and cause the unit to malfunction.
    - (d) Where flammable gas may leak, where there is carbon fiber, or ignitable dust suspension in the air, or where volatile flammables such as thinner or gasoline are handled. Operating the unit in such conditions can cause a fire.
  - Take adequate measures to prevent the outdoor unit from being used as a shelter by small animals. Small animals making contact with electrical parts can cause malfunctions, smoke, or fire. Instruct the user to keep the area around the unit clean.



### CAUTION

- Do not touch the switch with wet fingers. Touching a switch with wet fingers can cause electric shock.
- Do not allow children to play on or around the unit to prevent injury.
- The heat exchanger fins are sharp enough to cut. To avoid injury wear gloves or cover the fins while working around them.
- Do not touch the refrigerant pipes during and immediately after operation as the refrigerant pipes may be hot or cold, depending on the condition of the refrigerant flowing through the refrigerant piping, compressor, and other refrigerant cycle parts. Your hands may suffer burns or frostbite if you touch the refrigerant pipes. To avoid injury, give the pipes time to return to normal temperature or, if you must touch them, be sure to wear proper gloves.
- Install drain piping to proper drainage. Improper drain piping may result in water leakage and property damage.
- Insulate piping to prevent condensation.
- Be careful when transporting the product.
- Do not turn off the power immediately after stopping operation. Always wait for at least 5 minutes before turning off the power. Otherwise, water leakage may occur.
- Do not use a charging cylinder. Using a charging cylinder may cause the refrigerant to deteriorate.
- Refrigerant R410A in the system must be kept clean, dry, and tight.
  - (a) Clean and Dry -- Foreign materials (including mineral oils such as SUNISO oil or moisture) should be prevented from getting into the system.

### NOTE

- The outdoor unit should be positioned where the unit and power supply wires (breaker panel to outdoor unit) are at least 10ft (3m) away from any televisions or radios. (The unit may cause interference with the picture or sound.) Depending on the radio waves, a distance of 10ft (3m) may not be sufficient to eliminate the noise.
- Dismantling the unit, treatment of the refrigerant, oil and additional parts must be done in accordance with the relevant local, state, and national regulations.
- Do not use the following tools that are used with conventional refrigerants: gauge manifold, charge hose, gas leak detector, reverse flow check valve, refrigerant charge base, vacuum gauge, or refrigerant recovery equipment.
- If the conventional refrigerant and refrigerator oil are mixed in R410A, the refrigerant may deteriorate.
- This air conditioner or heat pump is an appliance that should not be accessible to the general public.
- As design pressure is 604 psi, the wall thickness of field-installed pipes should be selected in accordance with the relevant local, state, and national regulations.

# Accessories

(A) Installation manual	1	(B) Drain socket*  This is at the bottom of the packaging.	1
(C) Drain cap (1)* 	6	(D) Drain cap (2)* 	3
(E) Warranty	1	*Only for heat pump models.	

# Precautions for Selecting a Location

- 1) Choose a place solid enough to bear the weight and vibration of the unit, where the operating sound will not be amplified.
- 2) Choose a location where the hot air discharged from the unit or the operating sound will not cause a nuisance to the neighbors of the user.
- 3) Avoid locations, such as near bedrooms, where the operating sound may cause disturbance.
- 4) There must be sufficient space to carry the unit into and out of the site.
- 5) There must be sufficient space for air passage and no obstructions around the air inlet and the air outlet.
- 6) The site must not be prone to flammable gas leaks in the surrounding area.
- 7) In coastal areas or other places with a salty atmosphere or one containing sulfate gas, corrosion may shorten the life of the air conditioner.
- 8) Since water will flow from the drain of the outdoor unit, do not place under the unit anything which must be kept away from moisture.

**NOTE**

Cannot be installed suspended from a ceiling or stacked.

**⚠ CAUTION**

When operating the air conditioner in a low outdoor ambient temperature, be sure to follow the instructions described below.

- To prevent exposure to wind, install the outdoor unit with its suction side facing the wall.
- Never install the outdoor unit at a site where the suction side may be exposed directly to wind.
- To prevent exposure to wind, it is recommended to install a baffle plate on the air discharge side of the outdoor unit.
- In heavy snow areas, select an installation site where the snow will not affect the unit.

- Construct a large canopy.
- Construct a pedestal.



Install the unit high enough off the ground to prevent burying in snow.

# Precautions on Installation

- Check the strength and level of the installation surface so that the unit does not cause any operating vibrations or noise after installation.
- Fix the unit in place securely using foundation bolts, as in the figure. (Prepare 4 sets of 5/16 inch (M8) or 3/8 inch (M10) foundation bolts, nuts and washers; all separately available.)
- It is best to screw in the foundation bolts until their ends are 3/4 inch (20mm) from the foundation surface.

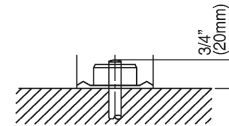

# Outdoor Unit Installation Diagram

Max. allowable piping length	98-1/2ft (30m)
Min. allowable piping length	10ft (3m)
Max. allowable piping height	65-5/8ft (20m)
Additional refrigerant required for refrigerant pipe exceeding 32.8ft (10m) in length.	0.32oz/ft (30g/m)
Gas pipe	O.D. 5/8 inch (15.9mm)
Liquid pipe	O.D. 1/4 inch (6.4mm)

\*Be sure to add the proper amount of additional refrigerant. Failure to do so may result in reduced performance.

\*\*The suggested shortest pipe length is 10ft (3m), in order to avoid noise from the outdoor unit and vibration. (Mechanical noise and vibration may occur depending on how the unit is installed and the environment in which it is used.)

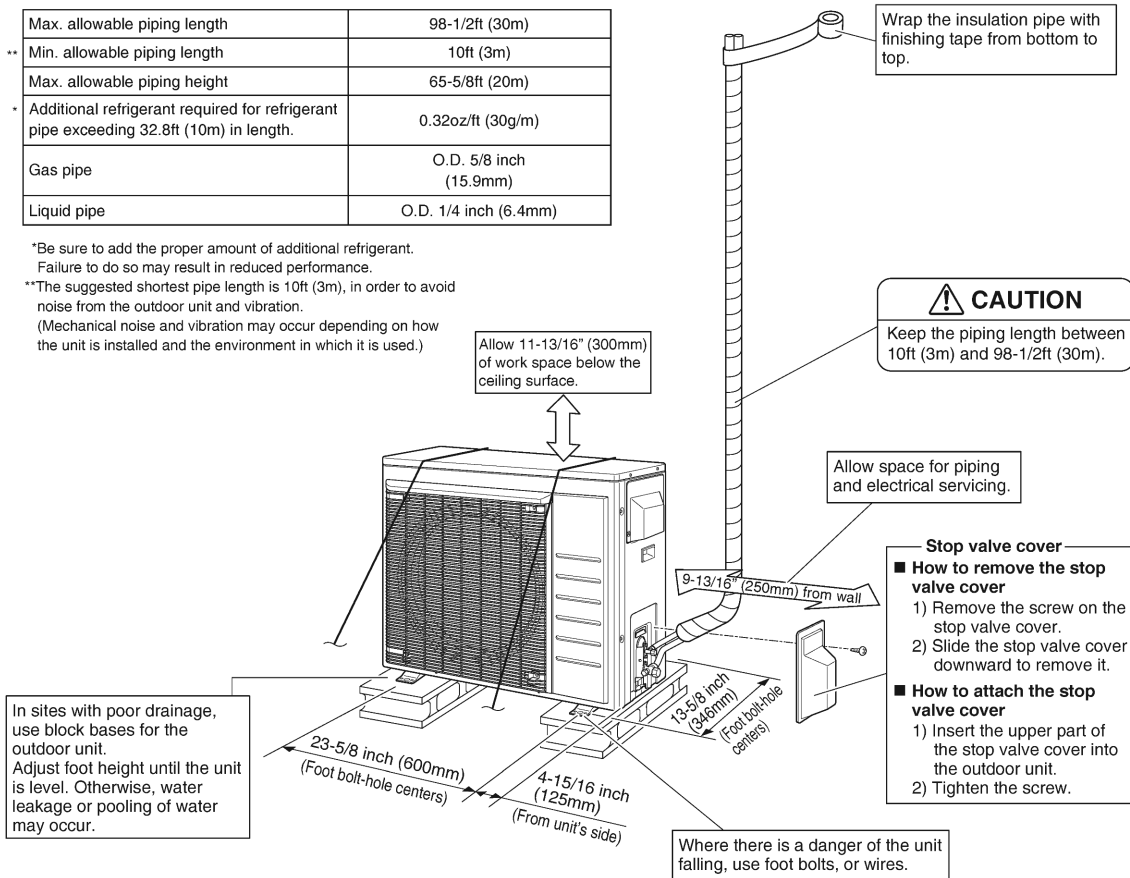

# Installation Space Requirements

- Position the unit on a horizontal surface.  
Any tilt in the unit (front to back, right to left) should be 3° or less to the horizontal.
- Where a wall or other obstacle is in the path of the outdoor unit's intake or exhaust airflow, follow the installation space requirements below.
- For any of the below installation patterns, the wall height on the outlet side should be 47-1/4 inch (1200mm) or less.

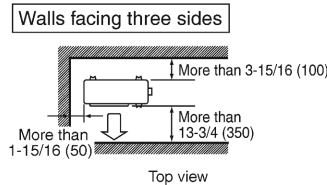
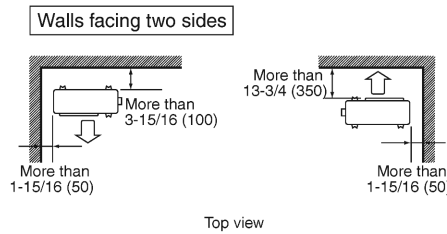
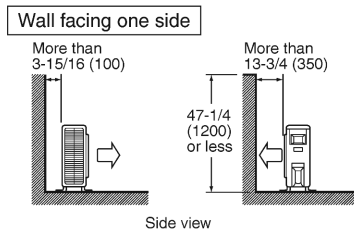
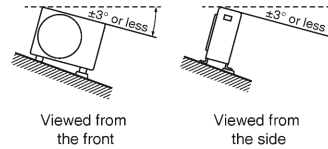

unit: inch (mm)

## Outdoor Unit Installation

### 1. Installing the outdoor unit

- 1) When installing the outdoor unit, refer to "Precautions for Selecting a Location" and the "Outdoor Unit Installation Diagram".
- 2) If drain work is necessary, follow the procedures in "2. Drain work".

### 2. Drain work (only for heat pump models)

- If the drain port is covered by a mounting base or floor surface, place additional foot bases of at least 1-1/4 inch (30mm) in height under the outdoor unit's feet.
- In cold areas, do not use a drain socket, drain caps (1,2) and a drain hose with the outdoor unit. (Drain water may freeze, impairing heating performance.)

- 1) Attach ① drain cap (1) and ② drain cap (2).
- 2) Attach ③ drain socket.
  - When attaching ③ drain socket to the bottom frame, make sure to connect the drain hose to the drain socket first.

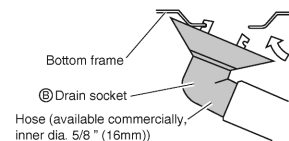
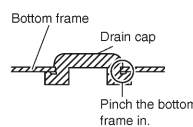
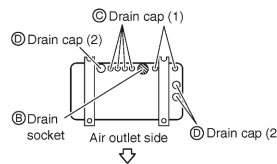

### 3. Flaring the pipe end

**⚠ WARNING**

- Do not apply mineral oil to the flare.
- Prevent mineral oil from getting into the system as this would reduce the service life of the units.
- Never use piping which has been used for previous installations. Only use parts which are delivered with this unit.
- Never install a dryer to this R410A unit in order to guarantee its service life.
- The drying material may dissolve and damage the system.
- Incomplete flaring may result in refrigerant gas leakage.

- 1) Cut the pipe end with a pipe cutter.
- 2) Remove burrs with the cut surface facing downward, so that the filings do not enter the pipe.
- 3) Put the flare nut on the pipe.
- 4) Flare the pipe.
- 5) Check that the flaring has been done correctly.

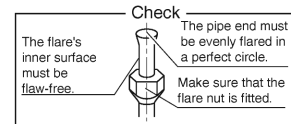
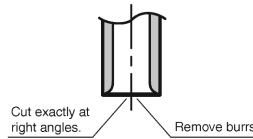

**Flaring**

Set exactly at the position shown below.

A	Flare tool for R410A	Conventional flare tool	
	Clutch-type	Clutch-type (Rigid-type)	Wing-nut type (Imperial-type)
	0-0.020 inch (0-0.5mm)	0.039-0.059 inch (1.0-1.5mm)	0.059-0.079 inch (1.5-2.0mm)

### 4. Refrigerant piping

**⚠ CAUTION**

- Use the flare nut fixed to the main unit. (This is to prevent the flare nut from cracking as a result of deterioration over time.)
- To prevent gas leakage, apply refrigeration oil only to the inner surface of the flare. (Use refrigeration oil for R410A.)
- Use a torque wrench when tightening the flare nuts to prevent damage to the flare nuts and gas leakage.

- Align the centers of both flares and tighten the flare nuts 3 or 4 turns by hand, then tighten them fully with a spanner and a torque wrench.

Flare nut tightening torque	
Gas side	Liquid side
5/8 inch (15.9mm)	1/4 inch (6.4mm)
45-5/8 – 55-5/8lbf • ft (61.8-75.4N • m)	10-1/2 – 12-3/4lbf • ft (14.2-17.2 N • m)

Width across flats	11/16 inch (17mm)	1-3/16 inch (30mm)
Valve cap tightening torque	10-1/2 – 12-5/8lbf • ft (14.2-17.2N • m)	16-5/8 – 20-1/4lbf • ft (22.5-27.5N • m)

Service port cap tightening torque	
8 – 10-7/8lbf • ft (10.8-14.7N • m)	

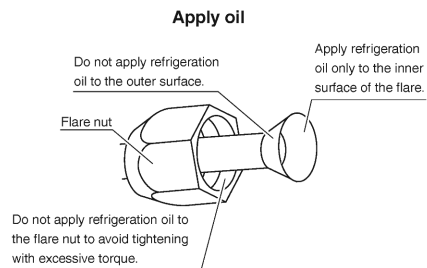

# Outdoor Unit Installation

## 5. Pressure test and evacuating system

### ⚠ WARNING

- Make sure that air or any matter other than refrigerant (R410A) does not get into the refrigeration cycle.
- If refrigerant gas leaks should occur, ventilate the room as soon and as much as possible.
- R410A, as well as other refrigerants, should always be recovered and never be released directly into the environment.
- Use a vacuum pump for R410A exclusively. Using the same vacuum pump for different refrigerants may damage the vacuum pump or the unit.

- When piping work is complete, it is necessary to perform a pressure test and evacuate system with a vacuum pump.
- If using additional refrigerant, purge the air from the refrigerant pipes and indoor unit using a vacuum pump, then charge additional refrigerant.
- Use a hexagonal wrench (3/16 inch (4mm)) to operate the stop valve rod.
- All refrigerant pipe joints should be tightened with a torque wrench to the specified tightening torque.

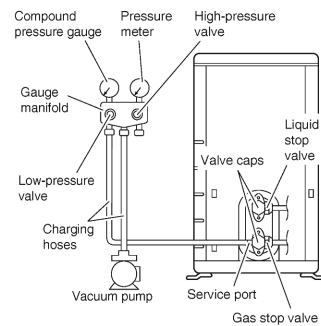

- 1) Pressurize the liquid pipe and gas pipe from the service ports of each stop valve to 550psi (3.8MPa) (do not pressurize more than 550psi (3.8MPa)) for 1 hour minimum, 24 hours recommended. If there is a pressure drop, check for leaks, make repairs and perform the pressure test again.
- 2) Connect the gauge manifold's charging hose to the gas stop valve's service port.
- 3) Fully open the gauge manifold's low-pressure valve (Lo) and completely close its high-pressure valve (Hi).  
(High-pressure valve will require no further operation.)
- 4) Evacuate system using vacuum pump to below 500 microns for 1 hour minimum.
- 5) Close the gauge manifold's low-pressure valve (Lo) and stop vacuum pump.  
(Maintain this condition for a few minutes to make sure that the compound pressure gauge pointer does not swing back.)\*<sup>1</sup>
- 6) Remove the valve caps from the liquid stop valve and gas stop valve.
- 7) Turn the liquid stop valve's rod 90° counter-clockwise with a hexagonal wrench to open the valve.  
Close it after 5 seconds, and check for gas leakage.  
Using soapy water, check for gas leakage from the indoor unit's flare and outdoor unit's flare and valve rods.  
After the check is complete, wipe all soapy water off.
- 8) Disconnect the charging hose from the gas stop valve's service port, then fully open the liquid and gas stop valves.  
(Do not attempt to turn the valve rod further than it can go.)
- 9) Tighten the valve caps and service port caps for the liquid and gas stop valves with a torque wrench to the specified torques.  
Refer to "4. Refrigerant piping" on page 6 for details.

\*<sup>1</sup> If the compound pressure gauge pointer swings back, the refrigerant may have water content or there may be a loose pipe joint.  
Check all pipe joints and retighten nuts as needed, then repeat steps 3) through 5).



## 6. Refilling refrigerant

Check the type of refrigerant to be used on the machine nameplate.

### Precautions when adding R410A

#### Fill from the liquid pipe in liquid form.

R410A is a mixed refrigerant, so adding it in gas form may cause the refrigerant composition to change, preventing normal operation.

- 1) Before filling, check whether the cylinder has a siphon attached or not. (It should have something like “liquid filling siphon attached” displayed on it.)

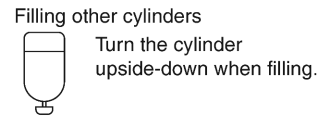
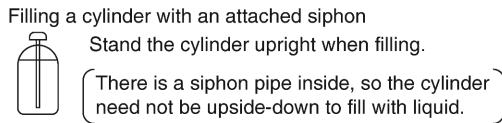

- Be sure to use the R410A tools to ensure pressure and to prevent foreign objects entering.

## 7. Refrigerant piping work

### 7-1. Cautions on pipe handling

- Protect the open end of the pipe from dust and moisture.
- All pipe bends should be as gentle as possible. Use a pipe bender for bending.

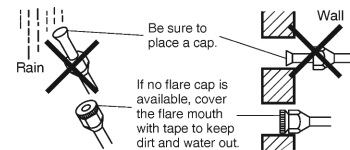

### 7-2. Selection of copper and heat insulation materials

When using commercial copper pipes and fittings, observe the following:

- Insulation material: Polyethylene foam  
Heat transfer rate: 0.041 to 0.052W/mK (0.024 to 0.030Btu/ft<sup>2</sup>°F (0.035 to 0.045kcal/mh°C))  
Be sure to use insulation that is designed for use with HVAC Systems.
- ACR Copper only.
- Be sure to insulate both the gas and liquid piping and observe the insulation dimensions as below.

	Piping size	Minimum bend radius	Piping thickness	Thermal insulation size	Thermal insulation thickness
Gas side	O.D. 5/8 inch (15.9mm)	1-15/16 inch (50mm) or more	0.039 inch (1.0mm) (C1220T-O)	I.D. 5/8-13/16 inch (16-20mm)	13/32 inch (10mm) Min.
Liquid side	O.D. 1/4 inch (6.4mm)	1-3/16 inch (30mm) or more	0.031 inch (0.8mm) (C1220T-O)	I.D. 5/16-13/32 inch (8-10mm)	

- Use separate thermal insulation pipes for gas and liquid refrigerant pipes.

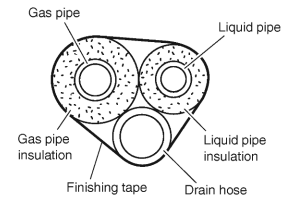

# Wiring

## ⚠ WARNING

- Do not use tapped wires, extension cords, or starburst connections, as they may cause overheating, electric shock, or fire.
- Do not use locally purchased electrical parts inside the product. (Do not branch the power for the drain pump, etc., from the terminal block.) Doing so may cause electric shock or fire.
- The circuit must be protected with safety devices in accordance with local and national codes, i.e. a fuse, a circuit breaker, a disconnect or a GFCI.
- Use an all-pole disconnection type circuit breaker with at least 1/8 inch (3mm) between the contact point gaps.
- When carrying out wiring, take care not to pull at the conduit.
- Do not connect the power wire to the indoor unit. Doing so may cause electric shock or fire.

## ⚠ CAUTION

### Precautions to be taken for power supply wiring

- When using stranded wires, make sure to use the round crimp-style terminal for connection to the power supply terminal block.

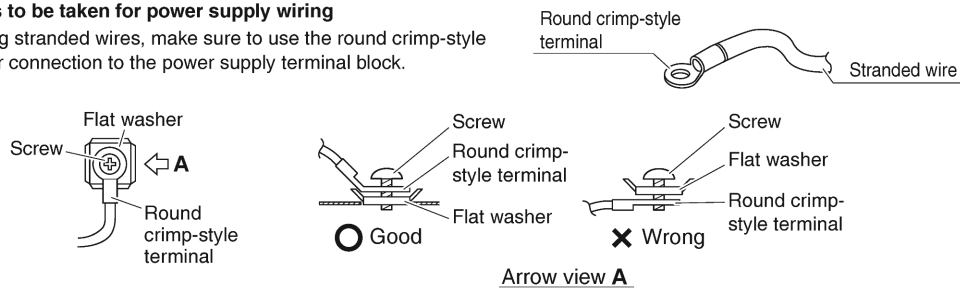

- When connecting the inter-unit wires to the terminal block using a single core wire, be sure to curl the end of the lead. Improper work may cause heat and fires.

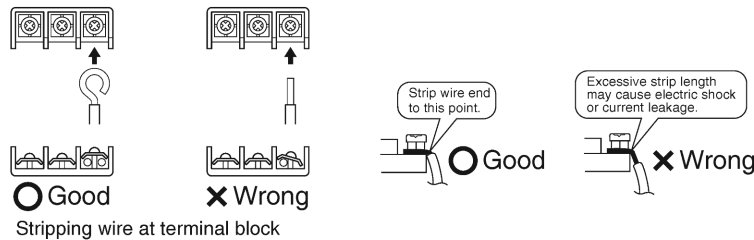

- Do not turn on the circuit breaker until all work is completed.
  - 1) Strip the insulation from the wire (3/4 inch (20mm)).
  - 2) Connect the inter-unit wires between the indoor and outdoor units so that the terminal numbers match. Tighten the terminal screws securely. It is recommended that a slot-head screwdriver be used to tighten the screws. The screws are packed with the terminal block.

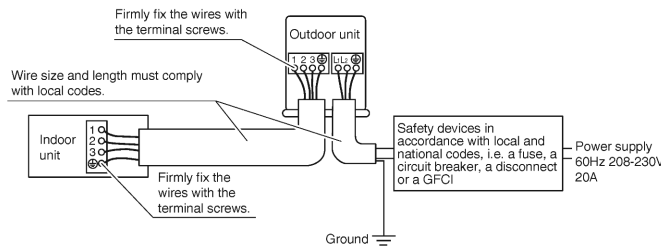

[Method of mounting conduit]

- 1) Dismount the service lid by removing the 2 screws.
- 2) Pass wires through the conduit and secure them with a lock nut.
- 3) After completing the work, reattach the service lid to its original position.

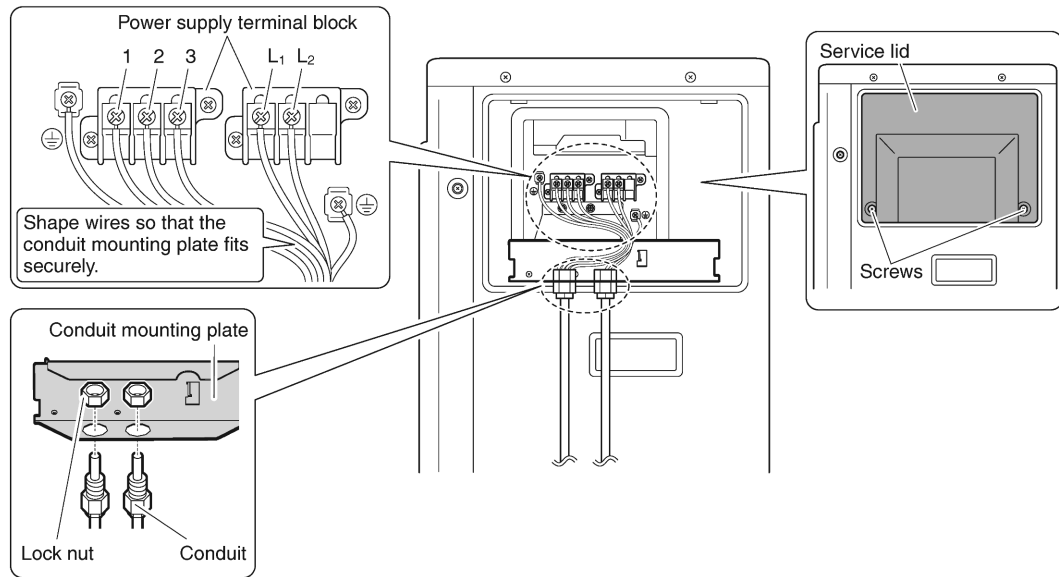

# Facility Setting (cooling at low outdoor temperature)

**⚠ WARNING** \_\_\_\_\_  
Make sure to turn the power OFF before removing the service lid.

**⚠ CAUTION** \_\_\_\_\_

- If the outdoor unit is installed where the heat exchanger of the unit is exposed to direct wind, provide a windbreak wall.
- Intermittent noises may be produced by the indoor unit due to the outdoor fan turning on and off when using facility settings.
- Do not place humidifiers or other items which might raise the humidity in rooms where facility settings are being used. A humidifier might cause dew condensation from the indoor unit outlet vent.
- Activating the facility setting sets the indoor fan tap to the highest position. Notify the user about this.
- When the outdoor temperature is below  $-4^{\circ}\text{F}$  ( $-20^{\circ}\text{C}$ ) and if SW6-2 in step 2) below is turned on, for the purpose of protecting the compressor, it may take up to 3 hours for operation to begin while the system warms up.

**This function is designed for facilities such as equipment or computer rooms. It is never to be used in a residence or office where people occupy the space.**

1) Turning on SW5-3 on the PCB will extend the operation range to  $14^{\circ}\text{F}$  ( $-10^{\circ}\text{C}$ ).  
Installing an air direction adjustment grille (sold separately) will further extend the operation range to  $-4^{\circ}\text{F}$  ( $-20^{\circ}\text{C}$ ). In these cases, the unit will stop operating if the outdoor temperature falls below  $-4^{\circ}\text{F}$  ( $-20^{\circ}\text{C}$ ), restarting once the temperature rises above this level.

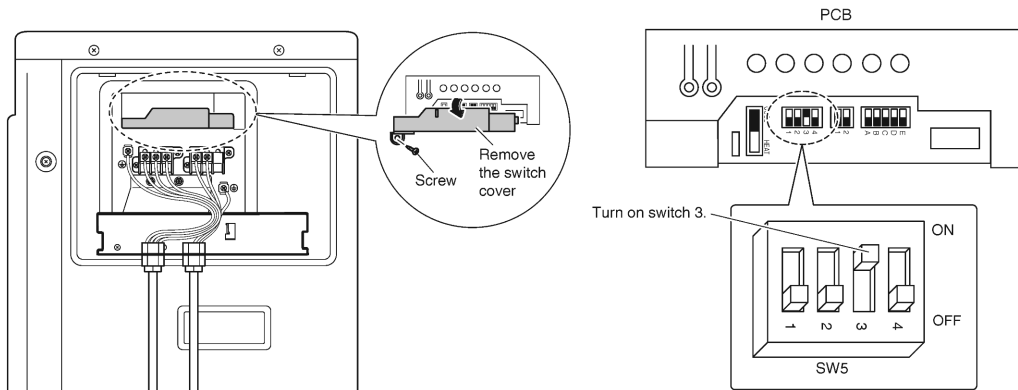

2) **Only for cooling models**  
If the unit is to be operated in outdoor temperatures down to  $-22^{\circ}\text{F}$  ( $-30^{\circ}\text{C}$ ), turn on SW6-2 on the PCB, in addition to the settings in step 1) above. If the outdoor temperature falls below  $-22^{\circ}\text{F}$  ( $-30^{\circ}\text{C}$ ) the unit will stop operating and will only restart once the temperature rises above  $-22^{\circ}\text{F}$  ( $-30^{\circ}\text{C}$ ).

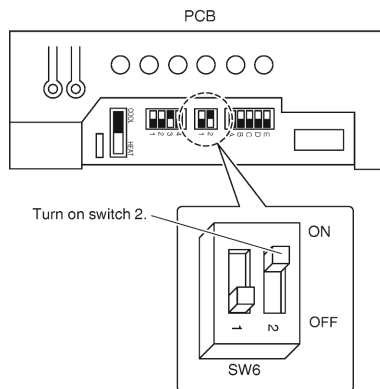

# Pump Down Operation

In order to protect the environment, be sure to pump down when relocating or disposing of the unit.

- 1) Remove the valve cap from the liquid stop valve and gas stop valve.
- 2) Carry out forced cooling operation.
- 3) After 5 to 10 minutes, close the liquid stop valve with a hexagonal wrench.
- 4) After 2 to 3 minutes, close the gas stop valve and stop forced cooling operation.
- 5) Attach the valve cap once procedures are complete.

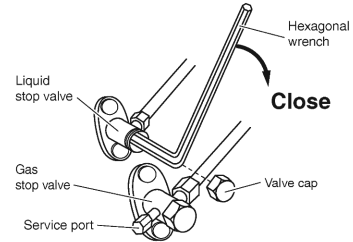







## Forced cooling operation

### ■ Using the indoor unit ON/OFF switch

Press the indoor unit ON/OFF switch for at least 5 seconds. (The operation will start.)

- Forced cooling operation will stop automatically after about 15 minutes. To stop the operation, press the indoor unit ON/OFF switch.

### ■ Using the indoor unit's remote controller

- 1) Press  and select the COOL operation.
- 2) Press  to turn on the system.
- 3) Press ,  and  at the same time.
- 4) Press , select "7", and press  for confirmation.

- Forced cooling operation will stop automatically after about 30 minutes. To stop the operation, press .

# Trial Operation and Testing

## 1. Trial operation and testing

Refer to the installation manual for the indoor unit.

## 2. Test items

Test items	Symptom	Check
Indoor and outdoor units are installed properly on solid bases.	Fall, vibration, noise	
No refrigerant gas leaks.	Incomplete cooling/heating function	
Refrigerant gas and liquid pipes and indoor drain hose extension are thermally insulated.	Water leakage	
Draining line is properly installed.	Water leakage	
System is properly grounded.	Electrical leakage	
The specified wires are used for inter-unit wiring.	No operation or burn damage	
Indoor or outdoor unit's air inlet or air outlet are unobstructed.	Incomplete cooling/heating function	
Stop valves are opened.	Incomplete cooling/heating function	
Indoor unit properly receives wireless remote control commands.	No operation	

# 12. Operation Manual

## Read Before Operation

### Safety Considerations

Read these **Safety Considerations for Operations** carefully before operating an air conditioner or heat pump.

Make sure that the unit operates properly during the startup operation. Instruct the user on how to operate and maintain the unit.

Inform users that they should store this operation manual with the installation manual for future reference.

Meanings of **DANGER**, **WARNING**, **CAUTION**, and **NOTE** Symbols:

- ⚠ DANGER** ..... Indicates an imminently hazardous situation which, if not avoided, will result in death or serious injury.
- ⚠ WARNING** ..... Indicates a potentially hazardous situation which, if not avoided, could result in death or serious injury.
- ⚠ CAUTION** ..... Indicates a potentially hazardous situation which, if not avoided, may result in minor or moderate injury. It may also be used to alert against unsafe practices.
- ⚠ NOTE** ..... Indicates situations that may result in equipment or property-damage accidents only.

#### — ⚠ DANGER —

- Do not install the unit in an area where flammable materials are present due to risk of explosion resulting in serious injury or death.
- Any abnormalities in the operation of the air conditioner or heat pump, such as smoke or fire, could result in severe injury or death. Turn off the power and contact your dealer immediately.
- Refrigerant gas may produce toxic gas if it comes into contact with fire, such as from a fan heater, stove, or cooking device. Exposure to this gas could cause severe injury or death.
- For refrigerant leakage, consult your dealer. Refrigerant gas is heavier than air and replaces oxygen. A massive leak could lead to oxygen depletion, especially in basements, and an asphyxiation hazard could occur leading to serious injury or death.
- If equipment utilizing a burner is used in the same room as the air conditioner or heat pump, there is the danger of oxygen deficiency which could lead to an asphyxiation hazard resulting in serious injury or death. Be sure to ventilate the room sufficiently to avoid this hazard.
- Safely dispose of the packing materials. Packing materials, such as nails and other metal or wooden parts, may cause stabs or other injuries.
- Tear apart and throw away plastic packaging bags so that children will not play with them. Children playing with plastic bags face the danger of death by suffocation.

#### — ⚠ WARNING —

- Contact your dealer for repair and maintenance. Improper repair and maintenance may result in water leakage, electric shock, and fire. Only use accessories made by Daikin that are specifically designed for use with the equipment and have them installed by a professional.
- Contact your dealer to move and reinstall the air conditioner or heat pump. Incomplete installation may result in water leakage, electric shock, and fire.
- Never let the indoor unit or the remote controller get wet. Water can cause an electric shock or a fire.
- Never use flammable spray such as hair spray, lacquer, or paint near the unit. Flammable spray may cause a fire.
- When a fuse blows out, never replace it with one of incorrect ampere ratings or different wires. Always replace any blown fuse with a fuse of the same specification.
- Never remove the fan guard of the unit. A fan rotating at high speed without the fan guard is very dangerous.
- Never inspect or service the unit by yourself. Contact a qualified service person to perform this work.
- Turn off all electrical power before doing any maintenance to avoid the risk of serious electric shock; never sprinkle or spill water or liquids on the unit.
- Do not touch the switch with wet fingers. Touching a switch with wet fingers can cause electric shock.
- Do not allow children to play on or around the unit to prevent injury.
- The heat exchanger fins are sharp enough to cut. To avoid injury wear gloves or cover the fins while working around them.
- Do not put a finger or other objects into the air inlet or air outlet. The fan is rotating at high speed and will cause injury.
- Check the unit foundation for damage on a continuous basis, especially if it has been in use for a long time. If left in a damaged condition the unit may fall and cause injury.
- Placing a flower vase or other containers with water or other liquids on the unit could cause a shock or fire if a spill occurs.
- Do not touch the air outlet or horizontal blades while the swing flap is in operation because fingers could get caught and injured.
- Never touch the internal parts of the controller. Do not remove the front panel because some parts inside are dangerous to touch. To check and adjust internal parts, contact your dealer.

#### — ⚠ CAUTION —

- Do not use the air conditioner or heat pump for any other purposes other than comfort cooling or heating. Do not use the unit for cooling precision instruments, food, plants, animals or works of art.

## Read Before Operation

- Do not place items under the indoor unit as they may be damaged by condensates that may form if the humidity is above 80% or if the drain outlet gets blocked.
  - Before cleaning, stop the operation of the unit by turning the power off or by pulling the supply cord out from its receptacle. Otherwise, an electric shock and injury may result.
  - Do not wash the air conditioner or heat pump with excessive water. An electric shock or fire may result.
  - Avoid placing the controller in a spot splashed with water. Water entering the controller may cause an electric shock or damage the internal electronic parts.
  - Do not operate the air conditioner or heat pump when using a room-fumigation type of insecticide. Failure to observe this could cause the chemicals to be deposited in the unit and can endanger the health of those who are hypersensitive to chemicals.
  - Do not turn off the power immediately after stopping operation. Always wait for at least 5 minutes before turning off the power. Otherwise, water leakage may occur.
  - The appliance is not intended for use by young children or infirm persons without supervision.
  - The remote controller should be kept away from children so they cannot play with it.
  - Consult with the installation contractor for cleaning.
  - Incorrect cleaning of the inside of the air conditioner or heat pump could make the plastics parts break and cause water leakage or electric shock.
  - Do not touch the air inlet or aluminum fin of the air conditioner or heat pump as they can cut and cause injury.
  - Do not place objects in direct proximity of the outdoor unit. Do not let leaves and other debris accumulate around the unit. Leaves are a hotbed for small animals which can enter the unit. Once inside the unit, animals can cause the unit to malfunction, and cause smoke or fire when they make contact with electrical parts.
-  **NOTE** —
- Never press the button of the remote controller with a hard, pointed object. The remote controller may be damaged.
  - Never pull or twist the electric wire of the remote controller. It may cause the unit to malfunction.
  - Do not place appliances that produce open flames in places that are exposed to the airflow of the unit or under the indoor unit. It may cause incomplete combustion or deformation of the unit due to the heat.
  - Do not expose the controller to direct sunlight. The LCD display can become discolored and may fail to display the data.
- Do not wipe the controller operation panel with benzene, thinner, chemical dust cloth, etc. The panel may get discolored or the coating can peel off. If it is heavily dirty, soak a cloth in water-diluted neutral detergent, squeeze it well and wipe the panel clean. Then wipe it with another dry cloth.
  - Dismantling of the unit, disposal of the refrigerant, oil, and additional parts, should be done in accordance with the relevant local, state, and national regulations.
  - Operate the air conditioner or heat pump in a sufficiently ventilated area and not surrounded by obstacles. Do not use the air conditioner or heat pump in the following places.
    - a. Places with a mist of mineral oil, such as cutting oil.
    - b. Locations such as coastal areas where there is a lot of salt in the air.
    - c. Locations such as hot springs where there is a lot of sulfur in the air.
    - d. Locations such as factories where the power voltage varies a lot.
    - e. In cars, boats, and other vehicles.
    - f. Locations such as kitchens where oil may splatter or where there is steam in the air.
    - g. Locations where equipment produces electromagnetic waves.
    - h. Places with an acid or alkaline mist.
    - i. Places where fallen leaves can accumulate or where weeds can grow.
  - Take snow protection measures. Contact your dealer for the details of snow protection measures, such as the use of a snow protection hood.
  - Do not attempt to do electrical work or grounding work unless you are licensed to do so. Consult with your dealer for electrical work and grounding work.
  - Pay attention to operating sound. Be sure to use the following places:
    - a. Places that can sufficiently withstand the weight of the air conditioner or heat pump yet can suppress the operating sound and vibration.
    - b. Places where warm air from the air outlet of the outdoor unit or the operating sound of the outdoor unit does not annoy neighbors.
  - Make sure that there are no obstacles close to the outdoor unit. Obstacles close to the outdoor unit may drop the performance of the outdoor unit or increase the operating sound of the outdoor unit.
  - Consult your dealer if the air conditioner or heat pump in operation generates unusual noise.
  - Make sure that the drainpipe is installed properly to drain water. If no water is discharged from the drainpipe while the air conditioner or heat pump is in the cooling mode, the drainpipe may be clogged with dust or dirt and water leakage from the indoor unit may occur. Stop operating the air conditioner or heat pump and contact your dealer.

**Read Before Operation**

# Names of Parts

## Indoor Unit

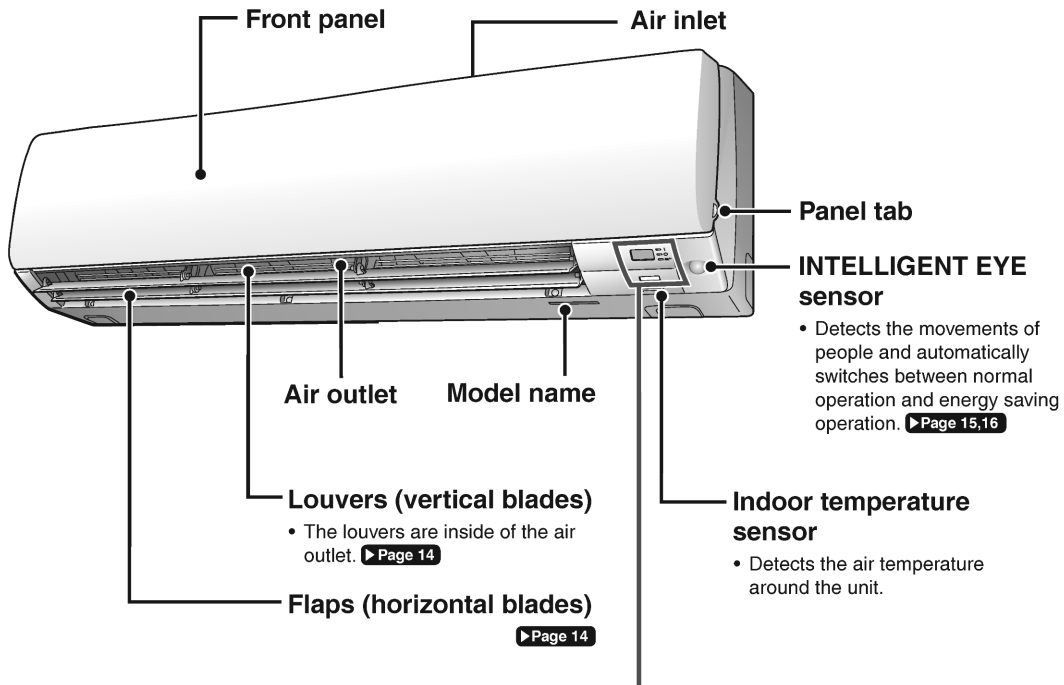

### Display

**Signal receiver**

- Receives signals from the remote controller.
- When the unit receives a signal, you will hear a beep sound.

Case	Sound type
Operation start	beep-beep
Setting changed	beep
Operation stop	long beep

**OPERATION lamp (green)**

**TIMER lamp (orange)**

▶ Page 19,20,23

**INTELLIGENT EYE lamp (green)**

▶ Page 15

**Indoor unit ON/OFF switch**

- Press this switch once to start operation. Press once again to stop it.
- For the operation mode setting, refer to the following table.

Model	Mode	Temperature setting	Airflow rate
HEAT PUMP	AUTO	77°F (25°C)	AUTO
COOLING ONLY	COOL	72°F (22°C)	AUTO

- This switch can be used when the remote controller is missing.



**Read Before Operation**

■ **Open the front panel**

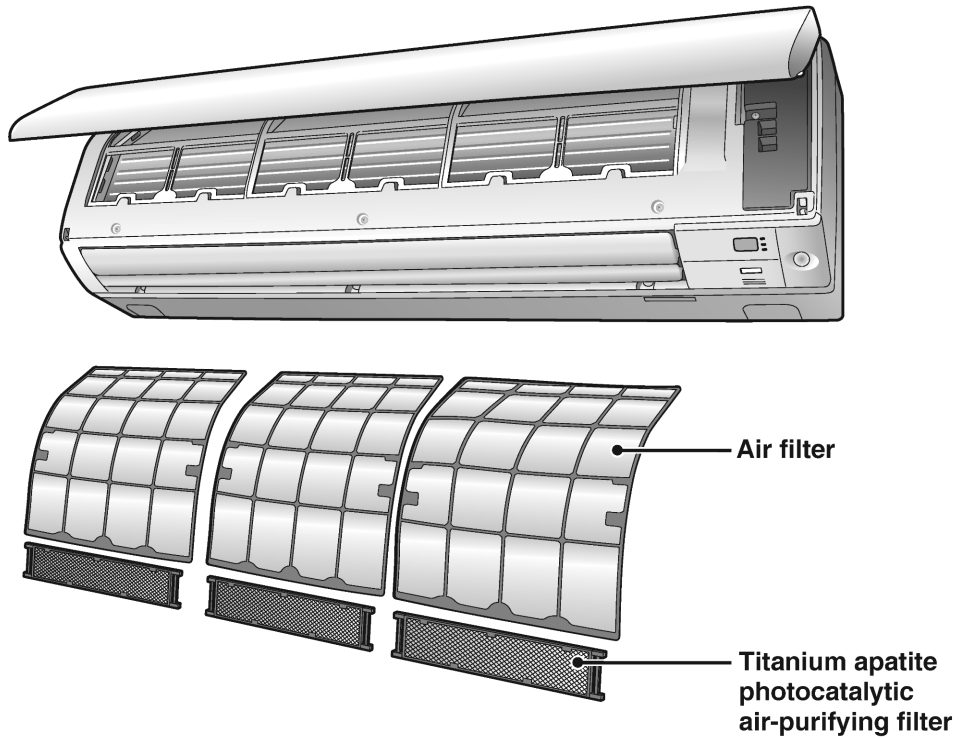

**Outdoor Unit**

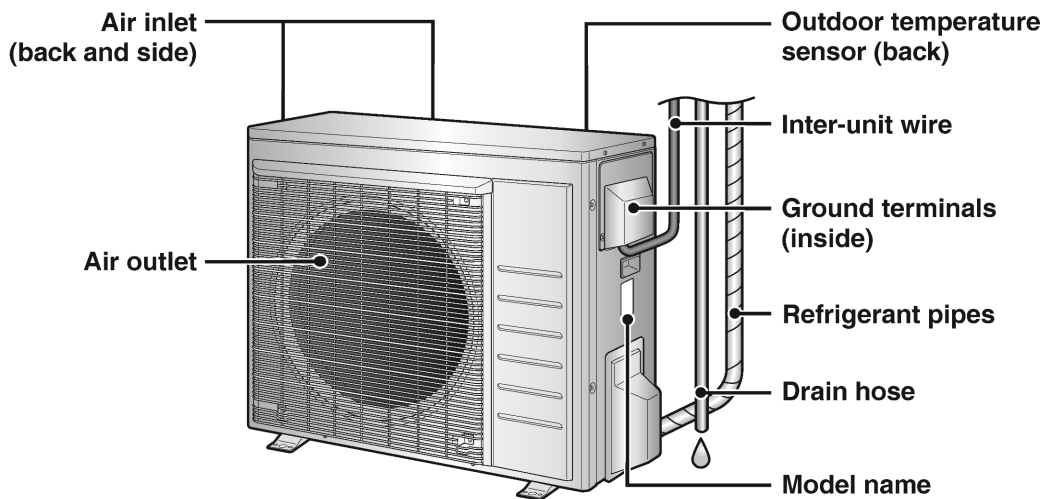

**Read Before Operation**

# Names of Parts

## Remote Controller

**Signal transmitter**

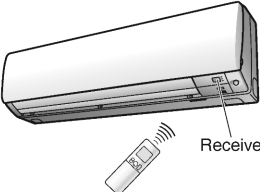

- To use the remote controller, aim the transmitter at the indoor unit. If there is anything blocking the signals between the unit and the remote controller, such as a curtain, the unit may not operate.
- The maximum transmission distance is about 23ft (7m).

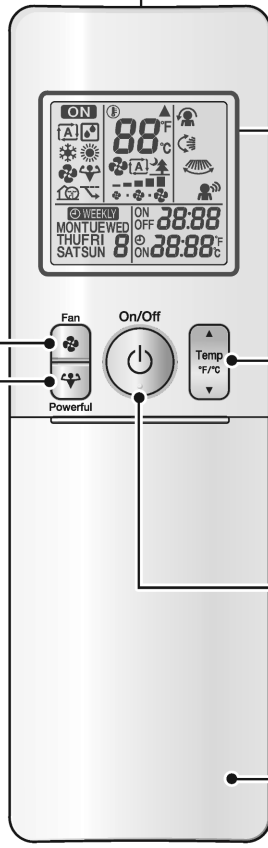

**Display (LCD)**

- Displays the current settings.  
(In this illustration, each section is shown with all its displays on for the purpose of explanation.)

**TEMPERATURE adjustment button**

- Changes the temperature setting. [▶ Page 12](#)

**ON/OFF button**

- Press this button once to start operation.  
Press once again to stop it. [▶ Page 11](#)

**FAN setting button**

- Selects the airflow rate setting. [▶ Page 13](#)

**POWERFUL button**

- POWERFUL operation. [▶ Page 17](#)

**Front cover**

- Open the front cover. [▶ Page 8](#)

Model	ARC466A37
-------	-----------

Read Before Operation

■ Open the front cover

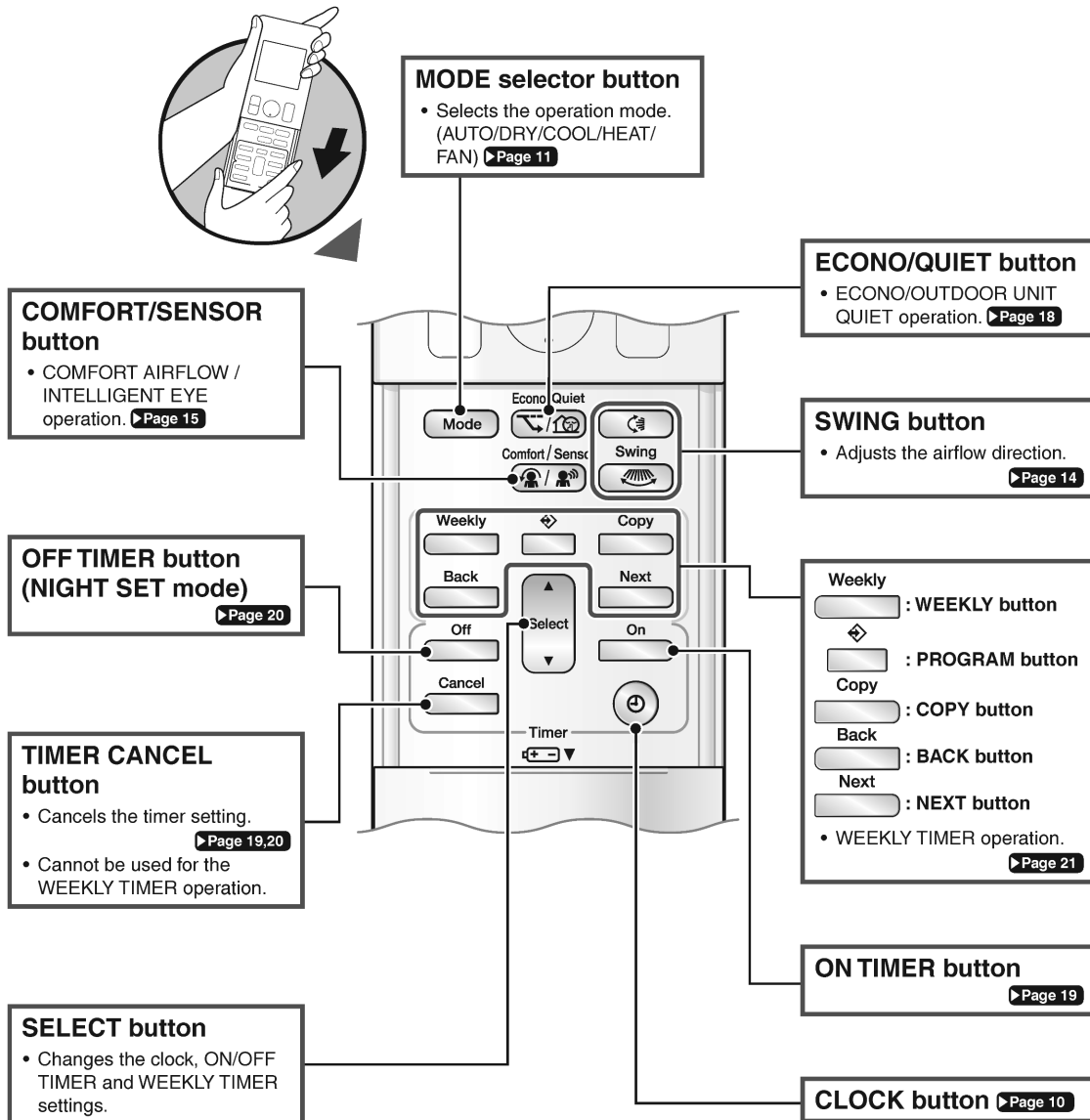

**Read Before Operation**

# Preparation Before Operation

## CAUTION

Incorrect handling of batteries can result in injury from battery leakage, rupturing or heating, or lead to equipment failure.

Please observe the following precautions and use safely.

- If the alkaline solution from the batteries should get in the eyes, do not rub the eyes. Instead, immediately flush the eyes with tap water and seek the attention of a medical professional.
- Keep batteries out of reach of children. In the event that batteries are swallowed, seek the immediate attention of a medical professional.
- Do not expose batteries to heat or fire. Do not disassemble or modify batteries. The insulation or gas release vent inside the battery may be damaged, resulting in battery leakage, rupturing, or heating.
- Do not damage or peel off labels on the batteries.

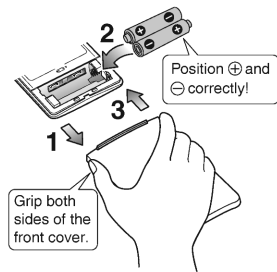

### To insert the batteries

1. Slide the front cover to take it off.
2. Insert 2 dry batteries AAA.LR03 (alkaline).
3. Replace the front cover.

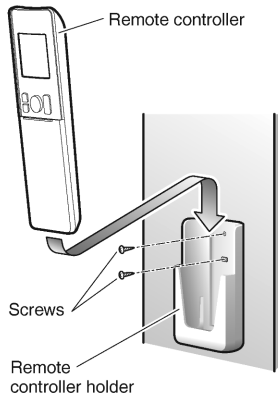



### To attach the remote controller holder to a wall

1. Choose a place where the signals reach the unit.
2. Attach the holder to a wall, a pillar, or similar location with the screws supplied with the holder.
3. Place the remote controller in the remote controller holder.

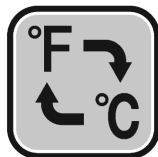
### Fahrenheit/Celsius display switch



Press  and  (TIMER button) simultaneously for about 5 seconds.

- The temperature will be displayed in Celsius when it is presently displayed in Fahrenheit, and vice versa.
- The switch operation is only possible when the temperature is being displayed.

## NOTE

### Notes on batteries

- To avoid possible injury or damage from battery leakage or rupturing, remove the batteries when not using the product for long periods of time.
- The standard replacement time is about 1 year. Both batteries should be replaced at the same time. Be sure to replace them with new size AAA. LR03 (alkaline) batteries. However, if the remote controller display begins to fade and the possible transmission range becomes shorter within a year, replace both batteries as specified above.
- The batteries supplied with the remote controller are for initial operation. The batteries may run out in less than 1 year.

### Note on remote controller

- Do not drop the remote controller. Do not get it wet.

## Read Before Operation

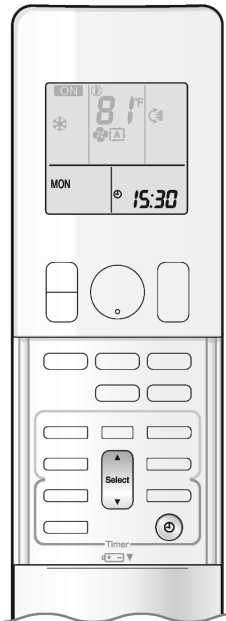

### Turn on the circuit breaker

- After the power is turned on, the flaps of the indoor unit open and close once to set the reference position.

### To set the clock

#### 1. Press .

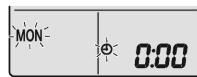

"0:00" is displayed on the LCD.  
"MON" and "⏻" blink.

#### 2. Press to set the current day of the week.

#### 3. Press .



"⏻" blinks.

#### 4. Press to set the clock to the present time.

- Holding down ▲ or ▼ rapidly increases or decreases the displayed time.

#### 5. Press .

- Point the remote controller at the indoor unit when pressing the buttons.



"." blinks.

## NOTE

### Fahrenheit/Celsius display change function of remote controller

- The set temperature may increase when the display is changed to Celsius from Fahrenheit, because a fraction of 0.5°C is rounded up.
- Example: A set temperature of 65°F (equivalent to 18.5°C) will be converted into 19°C.  
When the display is changed to Fahrenheit again, the set temperature will be converted into 66°F (equivalent to 19°C) instead of the original set temperature (65°F) but a set temperature of 66°F (equivalent to 19°C) will be converted into 19°C with no temperature change.
- A reception sound will go off for the transmission of set temperature to the indoor unit at the time of setting the Fahrenheit/Celsius display change function.

### Note on setting the clock

- If the indoor unit's internal clock is not set to the correct time, the ON/OFF TIMER and WEEKLY TIMER will not operate punctually.

**Basic Operation**



# AUTO · DRY · COOL · HEAT · FAN Operation

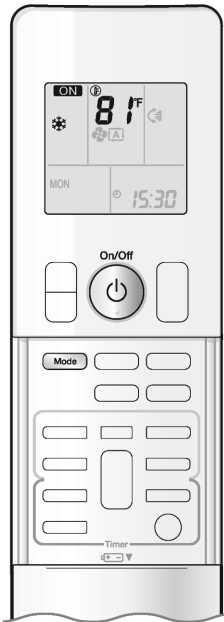

The air conditioner operates with the operation mode of your choice. From the next time on, the air conditioner will operate with the same operation mode.

**To start operation**

**1. Press  and select an operation mode.**

- Each pressing of the button changes the mode setting in sequence.

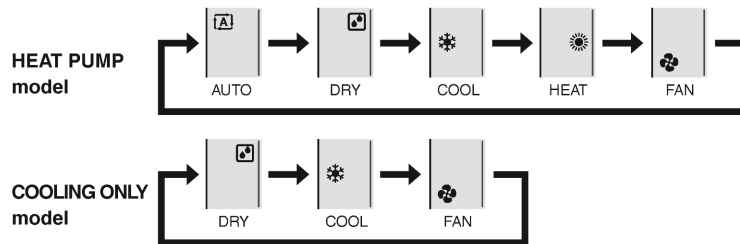

**2. Press .**

- “**ON**” is displayed on the LCD.
- The OPERATION lamp lights green.



Display

**To stop operation**

**Press  again.**

- “**ON**” disappears from the LCD.
- The OPERATION lamp goes off.

**NOTE**

**Notes on AUTO operation**

- In AUTO operation, the system selects an appropriate operation mode (COOL or HEAT) based on the indoor temperature and starts the operation.
- The system automatically reselects setting at a regular interval to bring the indoor temperature to the user-setting level.

**Note on DRY operation**

- Eliminates humidity while maintaining the indoor temperature as much as possible. It automatically controls temperature and airflow rate, so manual adjustment of these functions is unavailable.

## Basic Operation

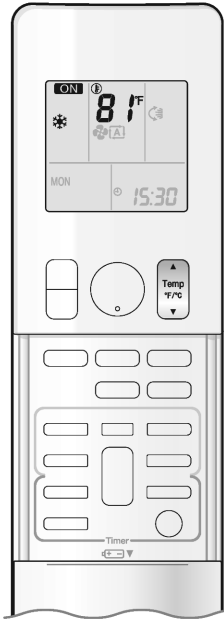

## To change the temperature setting

Press  .

- Press ▲ to raise the temperature and press ▼ to lower the temperature.

COOL operation	HEAT operation	AUTO operation	DRY or FAN operation
64-90°F (18-32°C)	50-86°F (10-30°C)	64-86°F (18-30°C)	The temperature setting cannot be changed.

### Tips for saving energy

**Keeping the temperature setting at a moderate level helps save energy.**

- Recommended temperature setting
  - For cooling: 78-82°F (26-28°C)
  - For heating: 68-75°F (20-24°C)

**Cover windows with a blind or a curtain.**

- Blocking sunlight and air from outdoors increases the cooling (heating) effect.

**Keep the air filter clean.**

- Clogged air filters cause inefficient operation and waste energy. Clean them once in about every 2 weeks. [▶ Page 29](#)

**If you are not going to use the air conditioner for a long period, for example in spring or autumn, turn off the circuit breaker.**

- The air conditioner always consumes a small amount of electricity even while it is not operating.



**Basic Operation**



# Adjusting the Airflow Rate

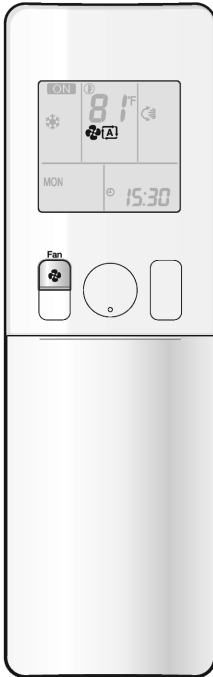

You can adjust the airflow rate to increase your comfort.

**To adjust the airflow rate setting**

Press .

- Each pressing of changes the airflow rate setting in sequence.

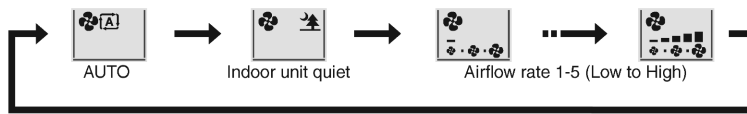

- When the airflow is set to “”, quiet operation starts and noise from the indoor unit will become quieter.
- In the quiet operation mode, the airflow rate is set to a weak level.
- In DRY operation, the airflow rate setting cannot be changed.

**NOTE**

**Note on airflow rate setting**

- At smaller airflow rates, the cooling (heating) effect is also smaller.



## Basic Operation



## Adjusting the Airflow Direction

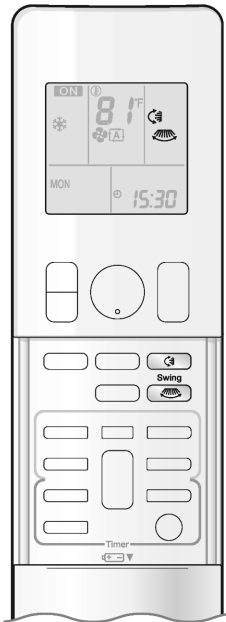

You can adjust the airflow direction to increase your comfort.

### ⚠ CAUTION

- Always use a remote controller to adjust the angles of the flaps and louvers.
  - If you attempt to move the flaps and louvers forcibly by hand when they are swinging, the mechanism may be damaged.
  - Inside the air outlet, a fan is rotating at a high speed.

### To start auto swing

#### Up and down airflow direction

▶ Press  .

- “” is displayed on the LCD.
- The flaps (horizontal blades) will begin to swing.

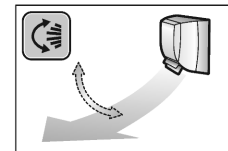

#### Right and left airflow direction



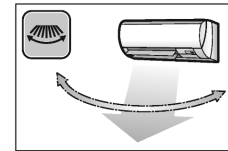

▶ Press  .

- “” is displayed on the LCD.
- The louvers (vertical blades) will begin to swing.



#### The 3-D airflow direction

▶ Press  and  .

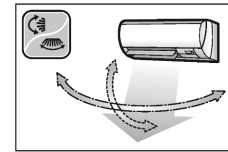

- “” and “” are displayed on the LCD.
- The flaps and louvers move in turn.
- To cancel 3-D airflow, press either  or  again. The flaps or louvers will stop moving.



### To set the flaps or louvers at the desired position

- This function is effective while the flaps or louvers are in auto swing mode.

▶ Press  and  when the flaps or louvers reach the desired position.

- In the 3-D airflow, the flaps and louvers move in turn.
- “” or “” disappears from the LCD.

### NOTE

#### Notes on airflow direction setting

- The movable range of the flaps varies according to the operation mode.
- The flaps will stop at the upper position when the airflow rate is changed to low during the up and down swing setting.

#### Note on 3-D airflow

- Using 3-D airflow circulates cold air, which tends to be collected at the bottom of the room, and hot air, which tends to collect near the ceiling, throughout the room, preventing areas of cold and hot developing.

#### Movable range of the flaps

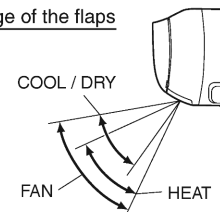

Useful Functions



# COMFORT AIRFLOW / INTELLIGENT EYE Operation

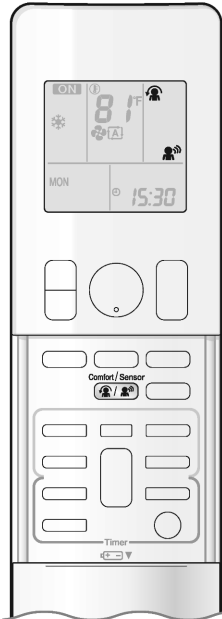

**COMFORT AIRFLOW operation:** The airflow direction is upward while in COOL and DRY operation, and downward while in HEAT operation. This function prevents cold or warm air from blowing directly on the occupants in the room.

**INTELLIGENT EYE operation:** The INTELLIGENT EYE sensor detects human movement. If no one is in the room for more than 20 minutes, the operation automatically changes to energy saving operation.

## CAUTION



- Do not place large objects near the INTELLIGENT EYE sensor. Also keep heating units and humidifiers outside the sensor's detection area. This sensor can detect undesirable objects.
- Do not hit or violently push the INTELLIGENT EYE sensor. This can lead to damage and malfunction.

### To start operation

Press  and select the desired mode.

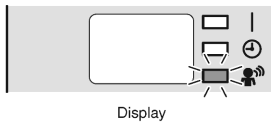
- Each time  is pressed, a different setting option is displayed on the LCD.
- When INTELLIGENT EYE is selected, the INTELLIGENT EYE lamp lights green.



- By selecting “ ” from the following icons, the air conditioner will switch to COMFORT AIRFLOW operation combined with INTELLIGENT EYE operation.

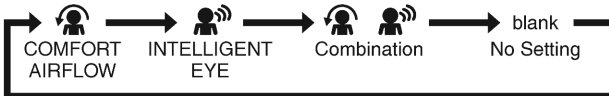

- When the flaps (horizontal blades) are swinging, selecting any of the modes above will cause the flaps (horizontal blades) to stop.

### To cancel operation

Press  until no icon is displayed.

- If the INTELLIGENT EYE operation was being used, the INTELLIGENT EYE lamp goes off.

## Useful Functions

**INTELLIGENT EYE operation is useful for energy saving**

## ■ People are detected in the sensing area.

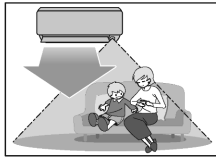

The air conditioner is in normal operation while the sensor is detecting human movement.

## ■ No people are detected in the sensing area.

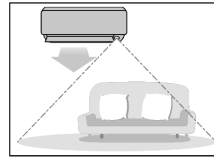

The air conditioner will switch to energy-saving mode after 20 minutes.

**Energy saving operation**

- If no presence is detected in the room for 20 minutes, the energy saving operation will start, and the INTELLIGENT EYE lamp goes off. If human movement is detected again, the INTELLIGENT EYE lamp lights up and energy saving operation terminates.
- This operation changes the temperature by  $-3.6^{\circ}\text{F}$  ( $-2^{\circ}\text{C}$ ) in HEAT /  $+3.6^{\circ}\text{F}$  ( $+2^{\circ}\text{C}$ ) in COOL /  $+3.6^{\circ}\text{F}$  ( $+2^{\circ}\text{C}$ ) in DRY operation from the set temperature.  
When the room temperature exceeds  $86^{\circ}\text{F}$  ( $30^{\circ}\text{C}$ ), the operation changes the temperature by  $+1.8^{\circ}\text{F}$  ( $+1^{\circ}\text{C}$ ) in COOL /  $+1.8^{\circ}\text{F}$  ( $+1^{\circ}\text{C}$ ) in DRY operation from the set temperature.
- This operation decreases the airflow rate slightly in FAN operation only.

**NOTE****Note on COMFORT AIRFLOW operation**

- The airflow rate will be set to AUTO. If the up and down airflow direction is selected, COMFORT AIRFLOW operation will be canceled.

**Notes on INTELLIGENT EYE operation**

- Application range is as follows.

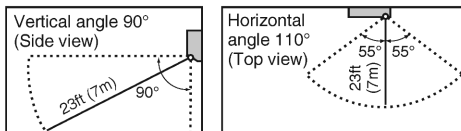

- The sensor may not detect moving objects further than 23ft (7m) away. (Please see the application range)
- Sensor detection sensitivity changes according to the indoor unit location, the speed of passers-by, temperature range, etc.
- The sensor could also mistakenly detect pets, sunlight, fluttering curtains and light reflected off of mirrors as passers-by.
- INTELLIGENT EYE operation will not switch on during POWERFUL operation.
- NIGHT SET mode [▶Page 20](#) will not switch on during use of INTELLIGENT EYE operation.

**Note on combination of COMFORT AIRFLOW operation and INTELLIGENT EYE operation**

- The airflow rate will be set to AUTO. If the up and down airflow direction is selected, COMFORT AIRFLOW operation will be canceled. Priority is given to the function of whichever button is pressed last.

Useful Functions



# POWERFUL Operation

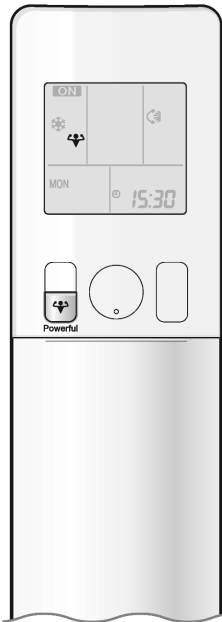

POWERFUL operation quickly maximizes the cooling (heating) effect in any operation mode. In this mode, the air conditioner operates at maximum capacity.

### To start POWERFUL operation

Press  during operation.

- “” is displayed on the LCD.
- POWERFUL operation ends in 20 minutes. Then the system automatically operates again with the previous settings which were used before POWERFUL operation.



### To cancel POWERFUL operation

Press  again.

- “” disappears from the LCD.

## NOTE

### Notes on POWERFUL operation

- Pressing  causes the settings to be canceled, and “” disappears from the LCD.
- POWERFUL operation will not increase the capacity of the air conditioner if the air conditioner is already in operation with its maximum capacity demonstrated.
  - In COOL, HEAT and AUTO operation  
To maximize the cooling (heating) effect, the capacity of outdoor unit increases and the airflow rate becomes fixed at the maximum setting. The temperature and airflow settings cannot be changed.
  - In DRY operation  
The temperature setting is lowered by 4.5°F (2.5°C) and the airflow rate is slightly increased.
  - In FAN operation  
The airflow rate is fixed at the maximum setting.

### Regarding the combination of POWERFUL and other operations

POWERFUL + COMFORT AIRFLOW	Not available*
POWERFUL + ECONO	
POWERFUL + OUTDOOR UNIT QUIET	

\*Priority is given to the function of whichever button is pressed last.

Useful Functions



# ECONO / OUTDOOR UNIT QUIET Operation

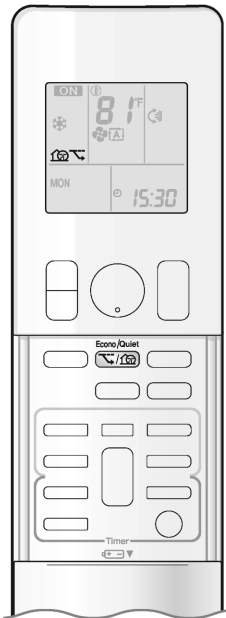

**ECONO operation** enables efficient operation by limiting the maximum power consumption.

This function is useful to prevent the circuit breaker from tripping when the unit operates alongside other appliances on the same circuit.

**OUTDOOR UNIT QUIET operation** lowers the noise level of the outdoor unit by changing the frequency and fan speed of the outdoor unit. This function is convenient during the night-time operation.

### To start operation

Press and select the desired mode.

- Each time is pressed, a different setting option is displayed on the LCD.

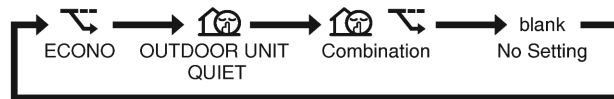

### To cancel operation

Press until no icon is displayed.

## NOTE

### Notes on ECONO operation

- Pressing causes the settings to be canceled, and “” disappears from the LCD.
- If the power consumption level is already low, switching to ECONO operation will not reduce the power consumption.

### Notes on OUTDOOR UNIT QUIET operation

- Even if the operation is stopped by using the remote controller or the indoor unit ON/OFF switch when using OUTDOOR UNIT QUIET operation, “” will remain displayed on the remote controller.
- OUTDOOR UNIT QUIET operation will not reduce the frequency nor fan speed if they already are operating at reduced levels.
- This operation is performed with lower power and therefore may not provide a sufficient cooling (heating) effect.

### Possible combinations of ECONO / OUTDOOR UNIT QUIET operation and basic operations

	Operation mode				
	AUTO	DRY	COOL	HEAT	FAN
ECONO	✓	✓	✓	✓	–
OUTDOOR UNIT QUIET	✓	–	✓	✓	–

**TIMER Operation**



# ON/OFF TIMER Operation

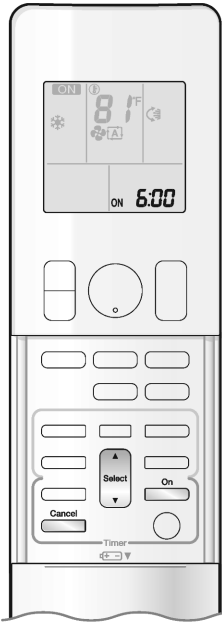

Timer functions are useful for automatically switching the air conditioner on or off in the morning or at night. You can also use the ON TIMER and OFF TIMER together.

## To use ON TIMER operation

- Check that the clock is correct.  
If not, set the clock to the present time. ▶Page 10

**1. Press** .

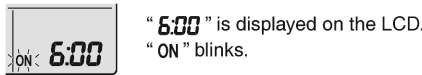

- “⊕” and day of the week disappear from the LCD.

**2. Press** **until the time setting reaches the point you like.**

- Each pressing of either button increases or decreases the time setting by 10 minutes.  
Holding down either button changes the setting rapidly.

**3. Press** **again.**

- “ON” and setting time are displayed on the LCD.
- The TIMER lamp lights orange. ▶Page 5

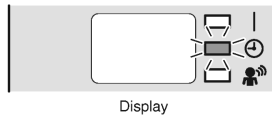

## To cancel ON TIMER operation

**Press** .

- “ON” and setting time disappear from the LCD.
- “⊕” and day of the week are displayed on the LCD.
- The TIMER lamp goes off.

### NOTE

**Notes on TIMER operation**

- When TIMER is set, the present time is not displayed.
- When using the ON/OFF TIMER to start/stop operation, the actual operation start/stop time may differ from the time set. (Maximum of about 10 minutes)
- The ON/OFF TIMER remembers the time set previously.
- The ON TIMER will begin operation in the settings used previously for operation mode, temperature, airflow rate, and airflow direction.

**In the following cases, set the timer again.**

- After the circuit breaker has turned off.
- After a power failure.
- After replacing the batteries in the remote controller.

## TIMER Operation

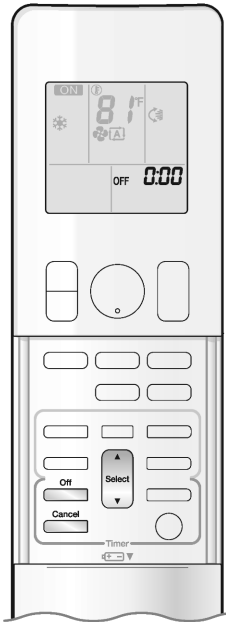

## To use OFF TIMER operation

- Check that the clock is correct.  
If not, set the clock to the present time. ▶ Page 10

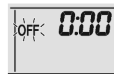
1. Press  .

“0:00” is displayed on the LCD.  
“OFF” blinks.

- “☉” and day of the week disappear from the LCD.

2. Press  until the time setting reaches the point you like.

- Each pressing of either button increases or decreases the time setting by 10 minutes.  
Holding down either button changes the time setting rapidly.

3. Press  again.

- “OFF” and setting time are displayed on the LCD.
- The TIMER lamp lights orange. ▶ Page 5

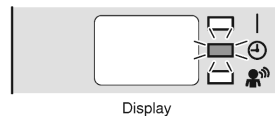

## To cancel OFF TIMER operation

Press  .

- “OFF” and setting time disappear from the LCD.
- “☉” and day of the week are displayed on the LCD.
- The TIMER lamp goes off.

## To combine ON TIMER and OFF TIMER operation

- A sample setting for combining the 2 timers is shown below.

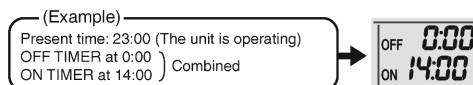

## NOTE

## NIGHT SET mode

- When the OFF TIMER is set, the air conditioner automatically adjusts the temperature setting (0.9°F (0.5°C) up in COOL, 3.6°F (2.0°C) down in HEAT) to prevent excessive cooling (heating) during sleeping hours.

**TIMER Operation**



# WEEKLY TIMER Operation

Up to 4 timer settings can be saved for each day of the week. This is convenient to adapt the WEEKLY TIMER to your family's life style.

## Setting example of the WEEKLY TIMER

The same timer settings are used from Monday through Friday, while different timer settings are used for the weekend.

<p><b>[Monday]</b></p>	<p>Make timer settings for programs 1-4. <a href="#">▶Page 22</a></p> <div style="display: flex; justify-content: space-around;"> <div style="text-align: center;"> <p><b>program 1</b></p> <p>ON</p> <p>77°F (25°C)</p> <p>6:00</p> <p>ON</p> </div> <div style="text-align: center;"> <p><b>program 2</b></p> <p>OFF</p> <p>8:30</p> <p>OFF</p> </div> <div style="text-align: center;"> <p><b>program 3</b></p> <p>ON</p> <p>17:30</p> <p>ON</p> </div> <div style="text-align: center;"> <p><b>program 4</b></p> <p>OFF</p> <p>22:00</p> <p>OFF</p> </div> </div>
<p><b>[Tuesday to Friday]</b></p>	<p>Use the copy mode to make settings for Tuesday to Friday, because these settings are the same as those for Monday. <a href="#">▶Page 24</a></p> <div style="display: flex; justify-content: space-around;"> <div style="text-align: center;"> <p><b>program 1</b></p> <p>ON</p> <p>77°F (25°C)</p> <p>6:00</p> <p>ON</p> </div> <div style="text-align: center;"> <p><b>program 2</b></p> <p>OFF</p> <p>8:30</p> <p>OFF</p> </div> <div style="text-align: center;"> <p><b>program 3</b></p> <p>ON</p> <p>17:30</p> <p>ON</p> </div> <div style="text-align: center;"> <p><b>program 4</b></p> <p>OFF</p> <p>22:00</p> <p>OFF</p> </div> </div>
<p><b>[Saturday]</b></p>	<p>No timer settings</p>
<p><b>[Sunday]</b></p>	<p>Make timer settings for programs 1-4. <a href="#">▶Page 22</a></p> <div style="display: flex; justify-content: space-around;"> <div style="text-align: center;"> <p><b>program 1</b></p> <p>ON</p> <p>77°F (25°C)</p> <p>8:00</p> <p>ON</p> </div> <div style="text-align: center;"> <p><b>program 2</b></p> <p>OFF</p> <p>10:00</p> <p>OFF</p> </div> <div style="text-align: center;"> <p><b>program 3</b></p> <p>OFF</p> <p>19:00</p> <p>OFF</p> </div> <div style="text-align: center;"> <p><b>program 4</b></p> <p>ON</p> <p>21:00</p> <p>ON</p> </div> </div>

- Up to 4 reservations per day and 28 reservations per week can be set using the WEEKLY TIMER. The effective use of the copy mode simplifies timer programming.
- The use of ON-ON-ON-ON settings, for example, makes it possible to schedule operating mode and set temperature changes. Furthermore, by using OFF-OFF-OFF-OFF settings, only the turn off time of each day can be set. This will turn off the air conditioner automatically if you forget to turn it off.



**TIMER Operation**

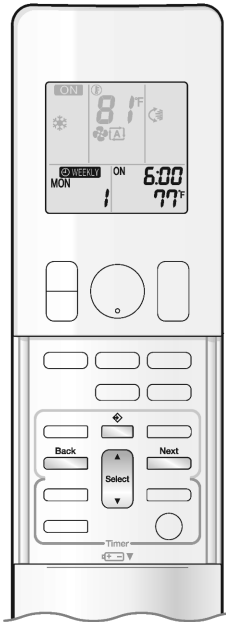

**To use WEEKLY TIMER operation**

**Setting mode**

- Make sure the day of the week and time are set. If not, set the day of the week and time. ▶ **Page 10**

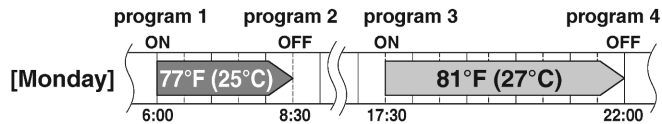

**Setting Displays**

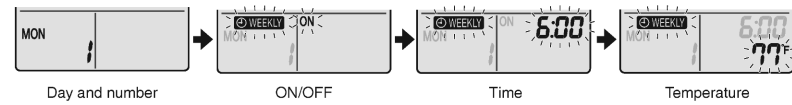

**1. Press** .

- The day of the week and the reservation number of the current day will be displayed.
- 1 to 4 settings can be made per day.

**2. Press** **to select the desired day of the week and reservation number.**

- Pressing changes the reservation number and the day of the week.

**3. Press** .

- The day of the week and reservation number will be set.
- “ WEEKLY” and “ON” blink.

**4. Press** **to select the desired mode.**

- Pressing changes the “ON” or “OFF” setting in sequence.



- In case the reservation has already been set, selecting “blank” deletes the reservation.
- Proceed to **STEP 9** if “blank” is selected.
- To return to the day of the week and reservation number setting, press .

**5. Press** .

- The ON/OFF TIMER mode will be set.
- “ WEEKLY” and the time blink.

**TIMER Operation**



# WEEKLY TIMER Operation

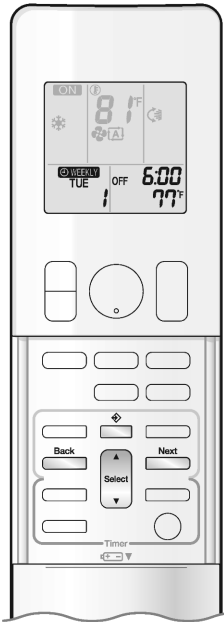

## 6. Press to select the desired time.

- The time can be set between 0:00 and 23:50 in 10-minute intervals.
- To return to the ON/OFF TIMER mode setting, press .
- Proceed to **STEP 9** when setting the OFF TIMER.

## 7. Press .

- The time will be set.
- “ WEEKLY” and the temperature blink.

## 8. Press to select the desired temperature.

- The temperature can be set between 50°F (10°C) and 90°F (32°C).  
 COOL or AUTO: The unit operates at 64°F (18°C) even if it is set at 50°F (10°C) to 63°F (17°C). **Page 12**  
 HEAT or AUTO: The unit operates at 86°F (30°C) even if it is set at 87°F (31°C) to 90°F (32°C). **Page 12**
- To return to the time setting, press .
- The set temperature is only displayed when the mode setting is on.

## 9. Press .

- Check for a receiving tone and that the OPERATION lamp blinks twice.
- The TIMER lamp lights orange.
- Temperature and time are set in the case of ON TIMER operation, and the time is set in the case of OFF TIMER operation.
- The next reservation screen will appear.
- To continue further settings, repeat the procedure from **STEP 4**.

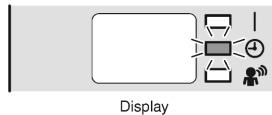

## 10. Press to complete the setting.

- “ WEEKLY” is displayed on the LCD and WEEKLY TIMER operation is activated.
- A reservation made once can be easily copied and the same settings used for another day of the week. Refer to **Copy mode**. **Page 24**

### NOTE

#### Notes on WEEKLY TIMER operation

- Do not forget to set the clock on the remote controller first. **Page 10**
- The day of the week, ON/OFF TIMER mode, time and set temperature (only for ON TIMER mode) can be set with the WEEKLY TIMER. When set to ON TIMER mode, operation will begin in the settings used previously for operation mode, temperature, airflow rate, and airflow direction.
- WEEKLY TIMER and ON/OFF TIMER operation cannot be used at the same time. The ON/OFF TIMER operation has priority if it is set while WEEKLY TIMER is still active. The WEEKLY TIMER will enter the standby state, and “ WEEKLY” will disappear from the LCD. When the ON/OFF TIMER is up, the WEEKLY TIMER will automatically become active.
- Turning off the circuit breaker, power failure, and other similar events will render operation of the indoor unit's internal clock inaccurate. Reset the clock. **Page 10**
- can be used only for the time and temperature settings. It cannot be used to go back to the reservation number.

## TIMER Operation

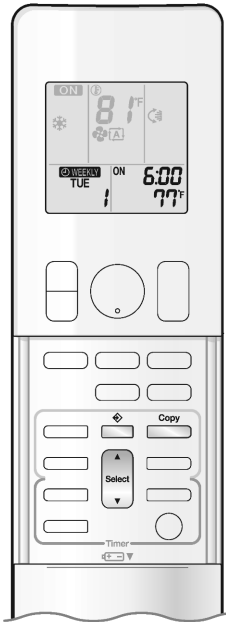

## Copy mode

- A reservation made once can be copied to another day of the week. The whole reservation of the selected day of the week will be copied.

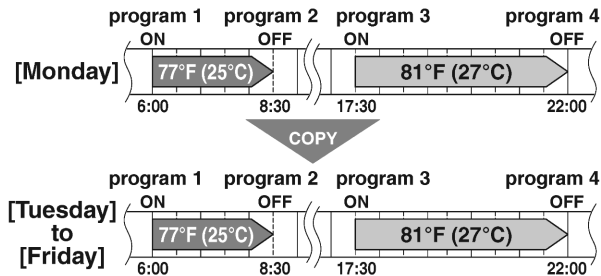

## Setting Displays

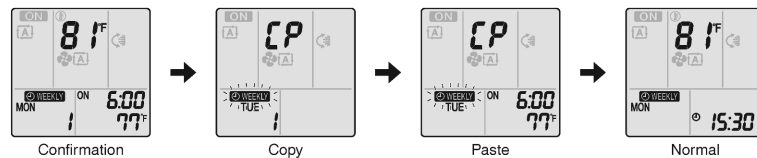

1. Press .

2. Press to confirm the day of the week to be copied.

3. Press .

- The whole reservation of the selected day of the week will be copied.

4. Press to select the destination day of the week.

5. Press .

- Check for a receiving tone and that the OPERATION lamp blinks twice.
- The reservation will be copied to the selected day of the week. The whole reservation of the selected day of the week will be copied.
- To continue copying the settings to other days of the week, repeat **STEP 4** and **STEP 5**.

6. Press to complete the setting.

- " WEEKLY " is displayed on the LCD and WEEKLY TIMER operation is activated.

## NOTE

## Note on COPY MODE

- The entire reservation of the source day of the week is copied in the copy mode.
- In the case of making a reservation change for any day of the week individually after copying the content of weekly reservations, press and change the settings in the steps of **Setting mode** . **Page 22**

**TIMER Operation**



# WEEKLY TIMER Operation



## Confirming a reservation

- The reservation can be confirmed.

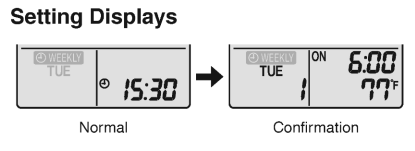

### 1. Press .

- The day of the week and the reservation number of the current day will be displayed.

### 2. Press to select the day of the week and the reservation number to be confirmed.

- Pressing displays the reservation details.
- To change the confirmed reserved settings, select the reservation number and press . The mode is switched to setting mode. Proceed to **Setting mode STEP 4. ▶ Page 22**

### 3. Press to exit the confirmation mode.

- “ WEEKLY” is displayed on the LCD and WEEKLY TIMER operation is activated.

## To deactivate WEEKLY TIMER operation

### Press while “ WEEKLY” is displayed on the LCD.

- “ WEEKLY” disappears from the LCD.
- The TIMER lamp goes off.
- To reactivate the WEEKLY TIMER operation, press again.
- If a reservation deactivated with is activated once again, the last reservation mode will be used.

## NOTE

- If not all the reservation settings are reflected, deactivate the WEEKLY TIMER operation once. Then press again to reactivate the WEEKLY TIMER operation.

## TIMER Operation

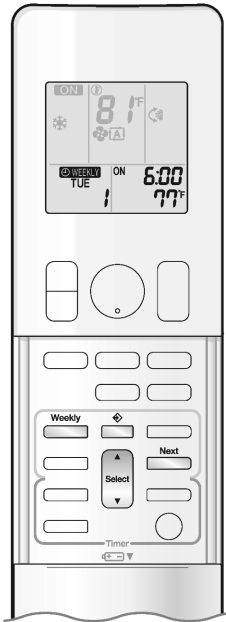

## To delete reservations

## An individual reservation

1. Press .

- The day of the week and the reservation number will be displayed.

2. Press  to select the day of the week and the reservation number to be deleted.3. Press .

- "WEEKLY" and "ON" or "OFF" blink.

4. Press  until no icon is displayed.

- Pressing  changes the ON/OFF TIMER mode in sequence.
- Selecting "blank" will cancel any reservation you may have.

5. Press .

- Check for a receiving tone and that the OPERATION lamp blinks twice.
- The selected reservation will be deleted.

6. Press .

- If there are still other reservations, WEEKLY TIMER operation will be activated.

## Reservations for each day of the week

- This function can be used for deleting reservations for each day of the week.
- It can be used while confirming or setting reservations.

1. Press .

- The day of the week and the reservation number will be displayed.

2. Press  to select the day of the week to be deleted.3. Hold  for about 5 seconds.

- Check for a receiving tone and that the OPERATION lamp blinks twice.
- The reservation of the selected day of the week will be deleted.

4. Press .

- If there are still other reservations, WEEKLY TIMER operation will be activated.

## All reservations

▶ Hold  for about 5 seconds with the normal display.

- Check for a receiving tone and that the OPERATION lamp blinks twice.
- "WEEKLY" disappears from the LCD.
- The TIMER lamp goes off.
- All reservations will be deleted.
- This operation is not functional while the WEEKLY TIMER setting screen is displayed.

Care

# Care and Cleaning

## ⚠ CAUTION

- Before cleaning, be sure to stop the operation and turn off the circuit breaker.
- Do not touch the aluminum fins of the indoor unit. If you touch those parts, this may cause an injury.

### ■ Quick reference

#### Cleaning parts

**Front panel**

- Wipe it with a soft damp cloth.

**If dirty** ▶ Page 28

**Air filter**

- Vacuum dust or wash the filter.

**Once every 2 weeks**

▶ Page 29

**Titanium apatite photocatalytic air-purifying filter**

- Vacuum dust or replace the filter.

[Cleaning]  
**Once every 6 months**

[Replacement]  
**Once every 3 years**

▶ Page 30

▶ Page 30

**Indoor unit and remote controller**

- Wipe them with a soft cloth.

**If dirty**

#### Notes on cleaning

**For cleaning, do not use any of the following:**

- Water hotter than 104°F (40°C)
- Volatile liquid such as benzine, gasoline and thinner
- Polishing compounds
- Rough materials such as a scrubbing brush



## CAUTION

- When removing or attaching the front panel, stand on a solid, stable base and take care not to fall.
- When removing or attaching the front panel, support the panel securely with your hand to prevent it from falling.

### ■ Front panel

#### 1. Open the front panel.

- Grip the panel tabs on each side of the front panel and open.

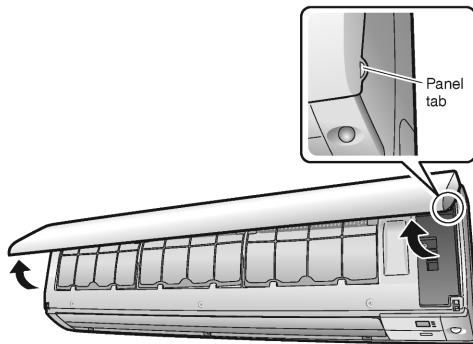

#### 2. Remove the front panel.

- 1) Slide the front panel to either the left or right and pull it toward you to disengage one of the front panel shafts.

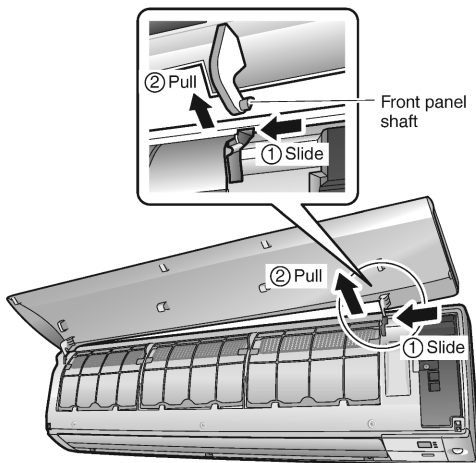

- 2) Disengage the front panel shaft on the other side in the same manner.
- 3) After disengaging both front panel shafts, pull the front panel toward yourself and remove it.

#### 3. Clean the front panel.

- Wipe it with a soft damp cloth.
- Only neutral detergent may be used.
- In case of washing the panel with water, wipe it with a dry soft cloth, and let it dry in the shade after washing.

#### 4. Attach the front panel.

- Align the front panel shaft on the left and right of the front panel with the grooves, then push them all the way in.

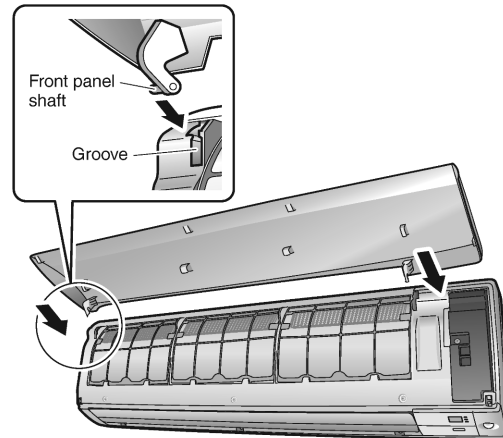

#### 5. Close the front panel slowly.

- Press the front panel at both sides and in the central area.

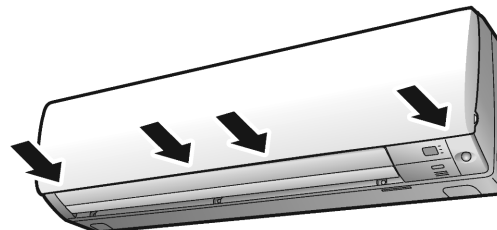

- Make sure that the front panel is securely fixed.

Care

# Care and Cleaning

## ■ Air filter

**1. Open the front panel.** ▶ Page 28

**2. Pull out the air filters.**

- Push the filter tab at the center of each air filter a little upwards, then pull it down.

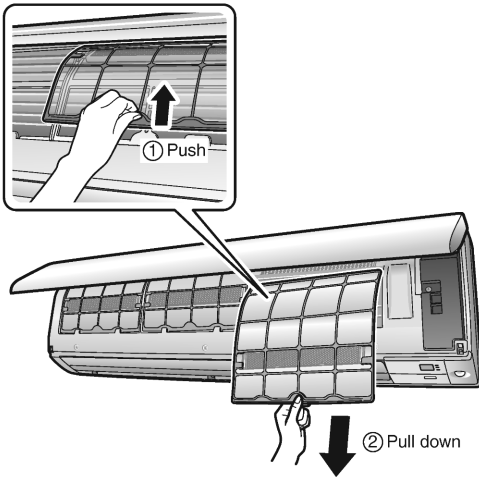

**3. Wash the air filters with water or clean them with a vacuum cleaner.**

- It is recommended to clean the air filters every 2 weeks.

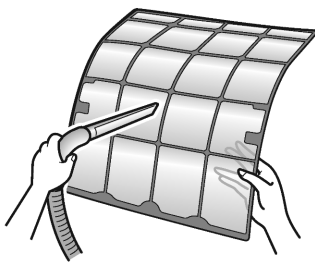

### If the dust does not come off easily

- Wash the air filters with neutral detergent thinned with lukewarm water, then let them dry in the shade.
- Be sure to remove the titanium apatite photocatalytic air-purifying filter. Refer to "Titanium apatite photocatalytic air-purifying filter" on the next page.

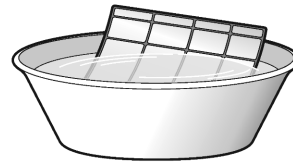

**4. Set the filters as they were.**

**5. Close the front panel slowly.**

▶ Page 28



## ■ Titanium apatite photocatalytic air-purifying filter

**1. Open the front panel and pull out the air filters.** ▶ Page 28,29

**2. Take off the titanium apatite photocatalytic air-purifying filters.**

- Hold the recessed parts of the frame and unhook the 4 claws.

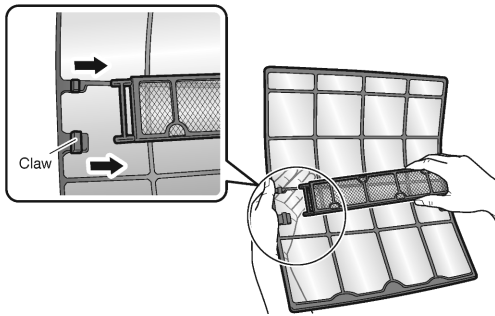

**3. Clean or replace the titanium apatite photocatalytic air-purifying filters.**

### [Cleaning]

**3-1 Vacuum dust, and soak in lukewarm water or water for about 10 to 15 minutes if very dirty.**

- Do not remove the filter from the frame when washing with water.

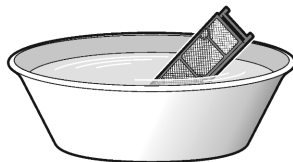

**3-2 After washing, shake off remaining water and let them dry in the shade.**

- Do not wring out the filter to remove water from it.

### [Replacement]

**Remove the filter from the filter frame and attach a new one.**

- Do not throw away the filter frame. Reuse the filter frame when replacing the titanium apatite photocatalytic air-purifying filter.
- When attaching the filter, check that the filter is properly set in the tabs.

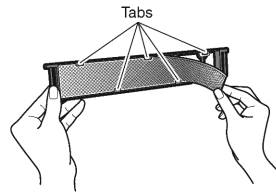

- Dispose of the old filter as non-flammable waste.

**4. Set the titanium apatite photocatalytic air-purifying filters as they were.**

**5. Set the air filters as they were.** ▶ Page 29

**6. Close the front panel slowly.** ▶ Page 28

### NOTE

- Operation with dirty filters:
  - cannot deodorize the air,
  - cannot clean the air,
  - results in poor heating or cooling,
  - may cause odor.
- Dispose of old filters as non-flammable waste.
- To order a titanium apatite photocatalytic air-purifying filter, contact the dealer where you bought the air conditioner.

Item	Titanium apatite photocatalytic air-purifying filter (set of 3)
Part No.	KAF970A48 (without frame)



## Care

## Care and Cleaning

---

### ■ Prior to a long period of non-use

#### **1. Operate the FAN mode for several hours to dry out the inside.**

- 1) Press  and select “”.
- 2) Press  and start the operation.

#### **2. After operation stops, turn off the circuit breaker for the room air conditioner.**

#### **3. Clean the air filters and reattach them.**

#### **4. To prevent battery leakage, take out the batteries from the remote controller.**

### ■ We recommend periodical maintenance

- In certain operating conditions, the inside of the air conditioner may get foul after several seasons of use, resulting in poor performance. It is recommended to have periodical maintenance by a qualified contractor in addition to regular cleaning by the user.
- For qualified contractor maintenance, please contact the dealer where you bought the air conditioner.

## When the Need Arises

## FAQ

## Indoor unit

**The flaps do not start swinging immediately.**

- The air conditioner is adjusting the position of the flaps. The flaps will start moving soon.

**The air conditioner stops generating airflow during HEAT operation.**

- Once the set temperature is reached, the airflow rate is reduced and operation stopped in order to avoid generating a cool airflow. Operation will resume automatically when the indoor temperature falls.

**HEAT operation stops suddenly and a flowing sound is heard.**

- The outdoor unit is defrosting. HEAT operation starts after the frost on the outdoor unit has been removed. This can take about 4 to 12 minutes.

**Operation does not start soon.**

- **When the unit is turned on again soon after being turned off.**
- **When the mode was reselected.**
  - This is to protect the air conditioner. You should wait for about 3 minutes.
- **For COOLING ONLY models (outdoor unit: RK models) using facility settings**
  - For the purposes of protecting the compressor, it can take up to 3 hours for operation to begin after the unit is turned on.

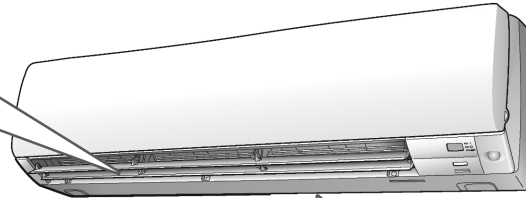
**Different sounds are heard.**

- **A sound like flowing water**
  - This sound is generated because the refrigerant in the air conditioner is flowing.
  - This is a pumping sound of the water in the air conditioner and can be heard when the water is pumped out from the air conditioner during COOL or DRY operation.
- **Blowing sound**
  - This sound is generated when the flow of the refrigerant in the air conditioner is switched over.
- **Ticking sound**
  - This sound is generated when the cabinet and frame of the air conditioner slightly expand or shrink as a result of temperature changes.
- **Whistling sound**
  - This sound is generated when refrigerant flows during defrosting operation.
- **Clicking sound during operation or idle time**
  - This sound is generated when the refrigerant control valves or the electrical parts operate.
- **Clopping sound**
  - This sound is heard from the inside of the air conditioner when the exhaust fan is activated while the room doors are closed. Open the window or turn off the exhaust fan.

## Outdoor unit

**Operating sound is loud.**

- When frost forms on the heat exchanger of the outdoor unit, the operating sound level increases slightly.

**The outdoor unit emits water or steam.**

- **In HEAT operation**
  - The frost on the outdoor unit melts into water or steam when the air conditioner is in defrosting operation.
- **In COOL or DRY operation**
  - Moisture in the air condenses into water on the cool surface of the outdoor unit piping and drips.

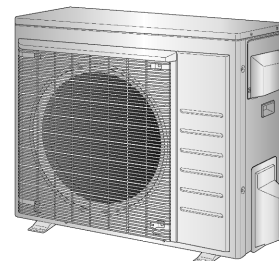

**When the Need Arises**

# Troubleshooting

Before making an inquiry or a request for repair, please check the following.  
If the problem persists, consult your dealer.



**Not a problem**

This case is not a problem.



**Check**

Please check again before requesting repairs.

## The air conditioner does not operate

Case	Description / what to check
<b>OPERATION lamp is off.</b>	<ul style="list-style-type: none"> <li>Has the circuit breaker been tripped or the fuse blown?</li> <li>Is there a power failure?</li> <li>Are batteries set in the remote controller?</li> </ul>
<b>OPERATION lamp is blinking.</b>	<ul style="list-style-type: none"> <li>Turn off the power with the circuit breaker and restart operation with the remote controller. If the OPERATION lamp is still blinking, check the error code and consult your dealer. <a href="#">▶Page 36</a></li> </ul>

## The air conditioner suddenly stops operating

Case	Description / what to check
<b>OPERATION lamp is on.</b>	<ul style="list-style-type: none"> <li>To protect the system, the air conditioner may stop operating after sudden large voltage fluctuations. It automatically resumes operation in about 3 minutes.</li> </ul>
<b>OPERATION lamp is blinking.</b>	<ul style="list-style-type: none"> <li>Are the air filters dirty? Clean the air filters.</li> <li>Is there anything blocking the air inlet or air outlet of the indoor unit or outdoor unit? Stop operation and after turning off the circuit breaker, remove the obstruction. Then restart operation with the remote controller. If the OPERATION lamp is still blinking, check the error code and consult your dealer. <a href="#">▶Page 36</a></li> </ul>

## The air conditioner does not stop operating

Case	Description / what to check
<b>The air conditioner continues operating even after operation is stopped.</b>	<ul style="list-style-type: none"> <li><b>Immediately after the air conditioner is stopped</b> <ul style="list-style-type: none"> <li>The outdoor unit fan continues rotating for about another 1 minute to protect the system.</li> </ul> </li> <li><b>While the air conditioner is not in operation</b> <ul style="list-style-type: none"> <li>When the outdoor temperature is high, the outdoor unit fan may start rotating to protect the system.</li> </ul> </li> </ul>

## The room does not cool down / warm up

Case	Description / what to check
<b>Air does not come out.</b>	<ul style="list-style-type: none"> <li><b>In HEAT operation</b> <ul style="list-style-type: none"> <li>The air conditioner is warming up. Wait for about 1 to 4 minutes.</li> <li>During defrosting operation, hot air does not flow out of the indoor unit.</li> </ul> </li> <li><b>When the air conditioner operates immediately after the circuit breaker is turned on</b> <ul style="list-style-type: none"> <li>The air conditioner is preparing to operate. Wait for about 3 to 10 minutes.</li> </ul> </li> </ul>
<b>Air does not come out / Air comes out.</b>	<ul style="list-style-type: none"> <li><b>Is the airflow rate setting appropriate?</b> <ul style="list-style-type: none"> <li>Is the airflow rate setting low, such as "Indoor unit quiet" or "Airflow rate 1"? Increase the airflow rate setting.</li> </ul> </li> <li><b>Is the set temperature appropriate?</b></li> <li><b>Is the adjustment of the airflow direction appropriate?</b></li> </ul>
<b>Air comes out.</b>	<ul style="list-style-type: none"> <li>Is there any furniture directly under or beside the indoor unit?</li> <li>Is the air conditioner in ECONO operation or OUTDOOR UNIT QUIET operation? <a href="#">▶Page 18</a></li> <li>Is the air filter dirty?</li> <li>Is there anything blocking the air inlet or air outlet of the indoor unit or outdoor unit?</li> <li>Is a window or door open?</li> <li>Is an exhaust fan turning?</li> </ul>

## When the Need Arises

## Mist comes out

Case	Description / what to check
Mist comes out of the indoor unit.	<input checked="" type="checkbox"/> • This happens when the air in the room is cooled into mist by the cold airflow during COOL or other operation.

## Remote controller

Case	Description / what to check
The unit does not receive signals from the remote controller or has a limited operating range.	<input checked="" type="checkbox"/> • The batteries may be exhausted. Replace both batteries with new dry batteries AAA.LR03 (alkaline). For details, refer to "Preparation Before Operation": <a href="#">▶ Page 9</a> <input checked="" type="checkbox"/> • Signal communication may be disabled if an electronic-starter-type fluorescent lamp (such as inverter-type lamps) is in the room. Consult your dealer if that is the case. <input checked="" type="checkbox"/> • The remote controller may not function correctly if the transmitter is exposed to direct sunlight.
LCD is faint, is not working, or the display is erratic.	<input checked="" type="checkbox"/> • The batteries may be exhausted. Replace both batteries with new dry batteries AAA.LR03 (alkaline). For details, refer to "Preparation Before Operation": <a href="#">▶ Page 9</a>
Other electric devices start operating.	<input checked="" type="checkbox"/> • If the remote controller activates other electric devices, move them away or consult your dealer.

## Air has an odor

Case	Description / what to check
The air conditioner gives off an odor.	<input checked="" type="checkbox"/> • The room odor absorbed in the unit is discharged with the airflow. We recommend you to have the indoor unit cleaned. Please consult your dealer.

## Others

Case	Description / what to check
The air conditioner suddenly starts behaving strangely during operation.	<input type="checkbox"/> • The air conditioner may malfunction due to lightning or radio. If the air conditioner malfunctions, turn off the power with the circuit breaker and restart the operation with the remote controller.
HEAT operation cannot be selected, even though the unit is heat pump model.	<input type="checkbox"/> • Check that the jumper (J8) has not been cut. If it has been cut, contact your dealer.
The ON/OFF TIMER does not operate according to the settings.	<input checked="" type="checkbox"/> • Check if the ON/OFF TIMER and the WEEKLY TIMER are set to the same time. Change or deactivate the settings in the WEEKLY TIMER. <a href="#">▶ Page 21</a>



## Notes on the operating conditions

- If operation continues under any conditions other than those listed in the table,
  - A safety device may activate to stop the operation.
  - Dew may form on the indoor unit and drip from it when COOL or DRY operation is selected.

Mode	Operating conditions
COOL / DRY	Outdoor temperature: 50-115°F (10-46°C) Indoor temperature: 64-90°F (18-32°C) Indoor humidity: 80% max.
HEAT	Outdoor temperature: 5-75°F (-15-24°C) Indoor temperature: 50-86°F (10-30°C)

**When the Need Arises**

# Troubleshooting

■ **Call your dealer immediately**

 **WARNING**

**When an abnormality (such as a burning smell) occurs, stop operation and turn off the circuit breaker.**

- Continued operation in an abnormal condition may result in problems, electric shock or fire.
- Consult the dealer where you bought the air conditioner.

**Do not attempt to repair or modify the air conditioner by yourself.**

- Incorrect work may result in electric shock or fire.
- Consult the dealer where you bought the air conditioner.

**If one of the following symptoms takes place, call your dealer immediately.**

- The power cord is abnormally hot or damaged.
- An abnormal sound is heard during operation.
- The circuit breaker, a fuse, or the GFCI cuts off the operation frequently.
- A switch or a button often fails to work properly.
- There is a burning smell.
- Water leaks from the indoor unit.

Turn off the circuit breaker and call your dealer. 

- **After a power failure**
  - The air conditioner automatically resumes operation in about 3 minutes. Please wait for a while.
- **Lightning**
  - If there is a risk lightning could strike in the neighborhood, stop operation and turn off the circuit breaker to protect the system.

■ **Disposal requirements**

- Dismantling of the unit, handling of the refrigerant, oil and other parts, should be done in accordance with the relevant local and national regulations.

When the Need Arises

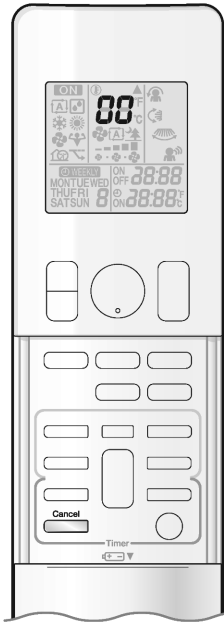

■ Fault diagnosis by remote controller

- The remote controller can receive relevant error codes from the indoor unit.

1. When **Cancel** is held down for about 5 seconds, “00” blinks in the temperature display section.

2. Press **Cancel** repeatedly until a long beep is produced.

- The code indication changes as shown below, and notifies you with a long beep.

	CODE	MEANING
SYSTEM	00	NORMAL
	U0	REFRIGERANT SHORTAGE
	U2	OVER-VOLTAGE DETECTION
	U4	SIGNAL TRANSMISSION ERROR (BETWEEN INDOOR AND OUTDOOR UNIT)
INDOOR UNIT	A1	INDOOR UNIT PCB ABNORMALITY
	A5	FREEZE-UP PROTECTION OR HEATING PEAK-CUT CONTROL
	A6	FAN MOTOR (DC MOTOR) ABNORMALITY
	C4	INDOOR HEAT EXCHANGER THERMISTOR ABNORMALITY
	C9	ROOM TEMPERATURE THERMISTOR ABNORMALITY
OUTDOOR UNIT	EA	FOUR WAY VALVE ABNORMALITY
	E1	OUTDOOR UNIT PCB ABNORMALITY
	E5	OL ACTIVATION (COMPRESSOR OVERLOAD)
	E6	COMPRESSOR LOCK
	E7	DC FAN LOCK
	F3	DISCHARGE PIPE TEMPERATURE CONTROL
	H0	COMPRESSOR SYSTEM SENSOR ABNORMALITY
	H6	POSITION SENSOR ABNORMALITY
	H8	DC VOLTAGE / CURRENT SENSOR ABNORMALITY
	H9	OUTDOOR TEMPERATURE THERMISTOR ABNORMALITY
	J3	DISCHARGE PIPE THERMISTOR ABNORMALITY
	J6	OUTDOOR HEAT EXCHANGER THERMISTOR ABNORMALITY
	L4	RADIATION FIN TEMPERATURE RISE
	L5	OUTPUT OVERCURRENT DETECTION
P4	RADIATION FIN THERMISTOR ABNORMALITY	

NOTE

- A short beep and 2 consecutive beeps indicate non-corresponding codes.
- To cancel the code display, hold **Cancel** down for about 5 seconds. The code display also clears if no button is pressed for 1 minute.

# Quick Reference

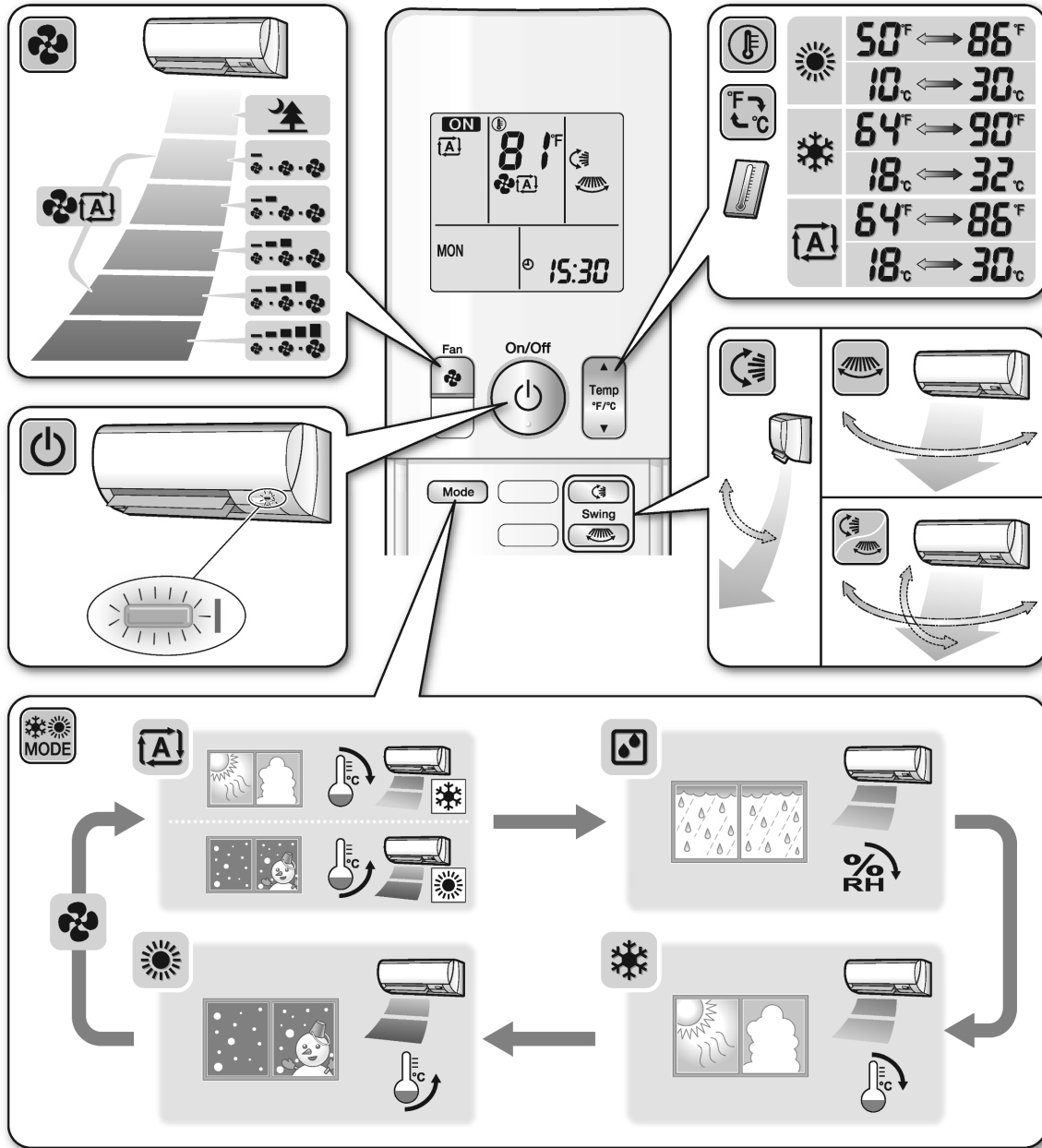

3P457796-1



## 13. Optional Accessories

### 13.1 Option List

#### 13.1.1 Indoor Unit

	Option Name	Model Name
1	Wired remote controller ★1	BRC944B2
2	Wired remote controller cord (shielded wire)	Length 9.8 ft (3 m)
		Length 26.3 ft (8 m)
3	Wireless LAN connection adaptor	BRP072A43
4	Wiring adaptor for timer clock / remote controller ★2 (normal open pulse contact / normal open contact)	KRP413AB1S
5	Central remote controller ★3	DCS302C71
6	Unified ON/OFF controller ★3	DCS301C71
7	Schedule timer controller ★3	DST301BA61
8	Interface adaptor for DIII-NET (residential air conditioner)	KRP928BB2S
9	Titanium apatite deodorizing filter (without frame) ★4	KAF970A48
10	Remote controller loss prevention with chain	KKF910AA4

- Notes:**
- ★1 A wired remote controller cord BRCW901A03 or BRCW901A08 is necessary.
  - ★2 Timer clock and other devices ; obtained locally.
  - ★3 An interface adaptor (KRP928BB2S) is also required for each indoor unit.
  - ★4 Standard accessory

#### 13.1.2 Outdoor Unit

	Option Name	Model Name
1	Air direction adjustment grille	KPW063A4
2	Back protection wire net	KKG063A42
3	Drain plug ★	KKP937A4
4	Drain pan heater	FTDBHML, KEH063A4E
5	Snow hood (intake side plate)	KPS063A41
6	Snow hood (intake rear plate)	KPS063A44
7	Snow hood (outlet)	KPS063A47

- Note:** ★ Standard accessory for heat pump model

## 13.2 <BRC944B2> Wired Remote Controller

### 13.2.1 Installation Manual

#### **⚠ CAUTION**

1. No switch box or staple is supplied. Prepare them locally.
2. No remote controller cord is supplied. Prepare the optional remote controller cord 4 wire.
3. Be sure to turn off the power to any apparatus connected prior to mounting.
4. Prior to mounting equipment, touch something metallic such as a doorknob to remove static electricity from your body. Never touch the remote controller board or the adapter board.
5. Keep the wiring away from any other power source lines to avoid electric noise (external noise).
6. Select a flat surface, wherever possible, to mount the remote controller. To prevent deformation of the cases, do not overtighten the mounting screws.

#### 1. Securing the remote controller lower case

Insert a bladed screwdriver into the concave (凹) in the remote controller lower case to remove the upper case assembly (two locations).

The remote controller board is located on the upper case. Take care not to scratch the board with the screwdriver.

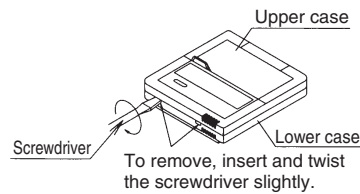

- (1) Exposed mounting  
Secure the remote controller lower case with the two supplied wood screws.

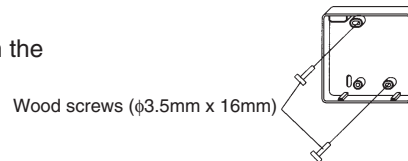

- (2) Embedded mounting  
Secure the remote controller lower case with the two supplied machine screws.

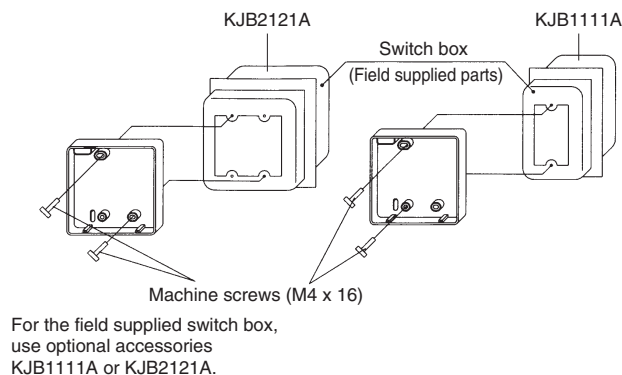

**2. Securing the remote control adapter**

Remove the upper case of the remote control adapter and secure the lower case assembly.

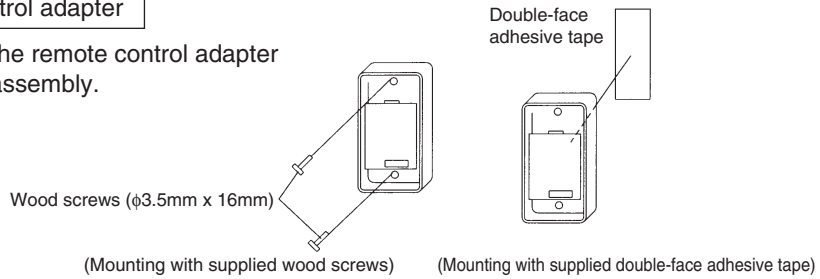

**3. Wiring**

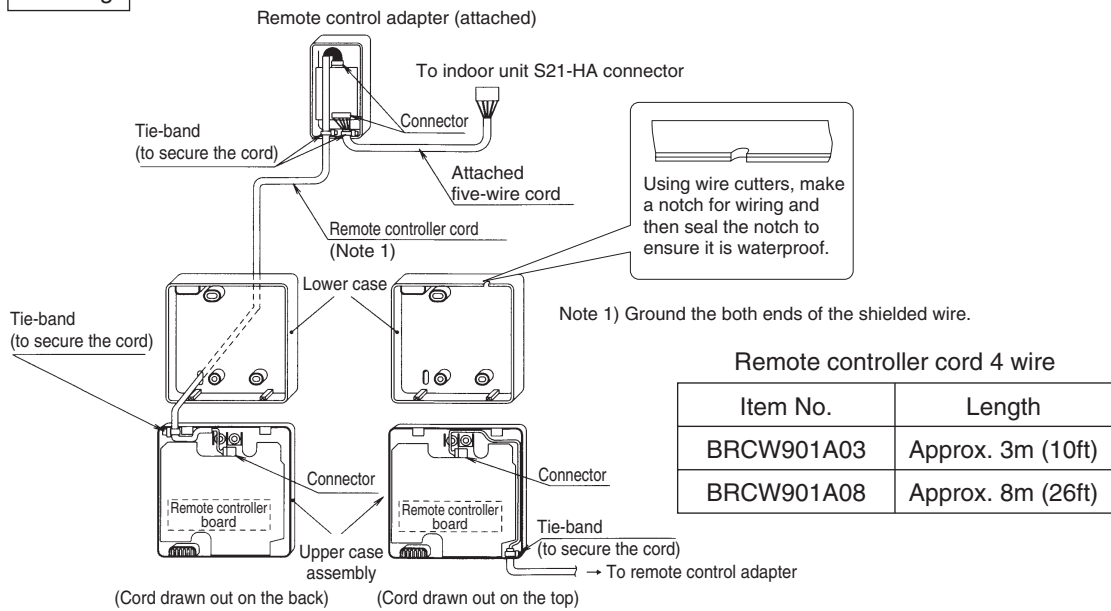

**4. Placing the upper case assembly of the remote controller and the upper case of the remote controller adapter back into their original positions**

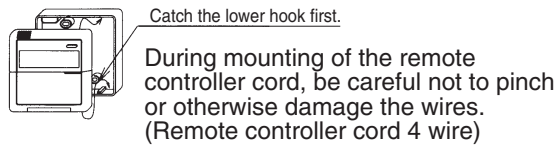

**5. Temperature indication change**

To change from Celsius temperature indication to Fahrenheit one

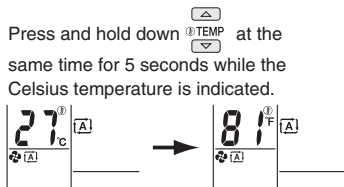

← See Operation Manual

13.2.2 Operation Manual

# Controller Commands and their Corresponding Functions

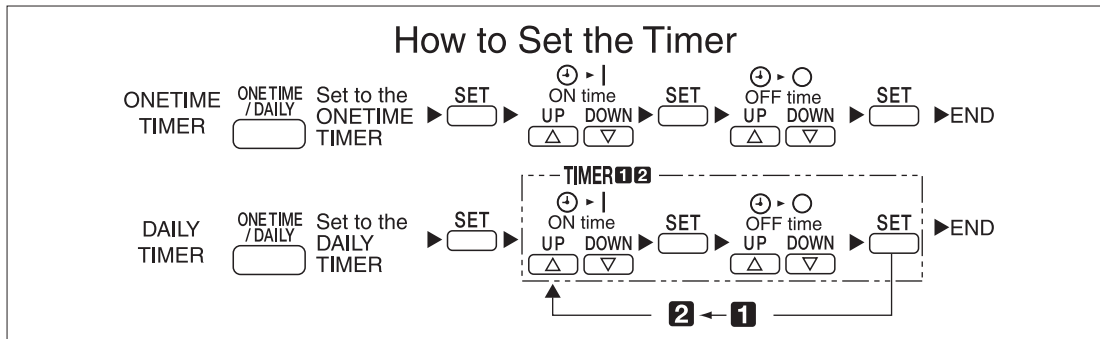
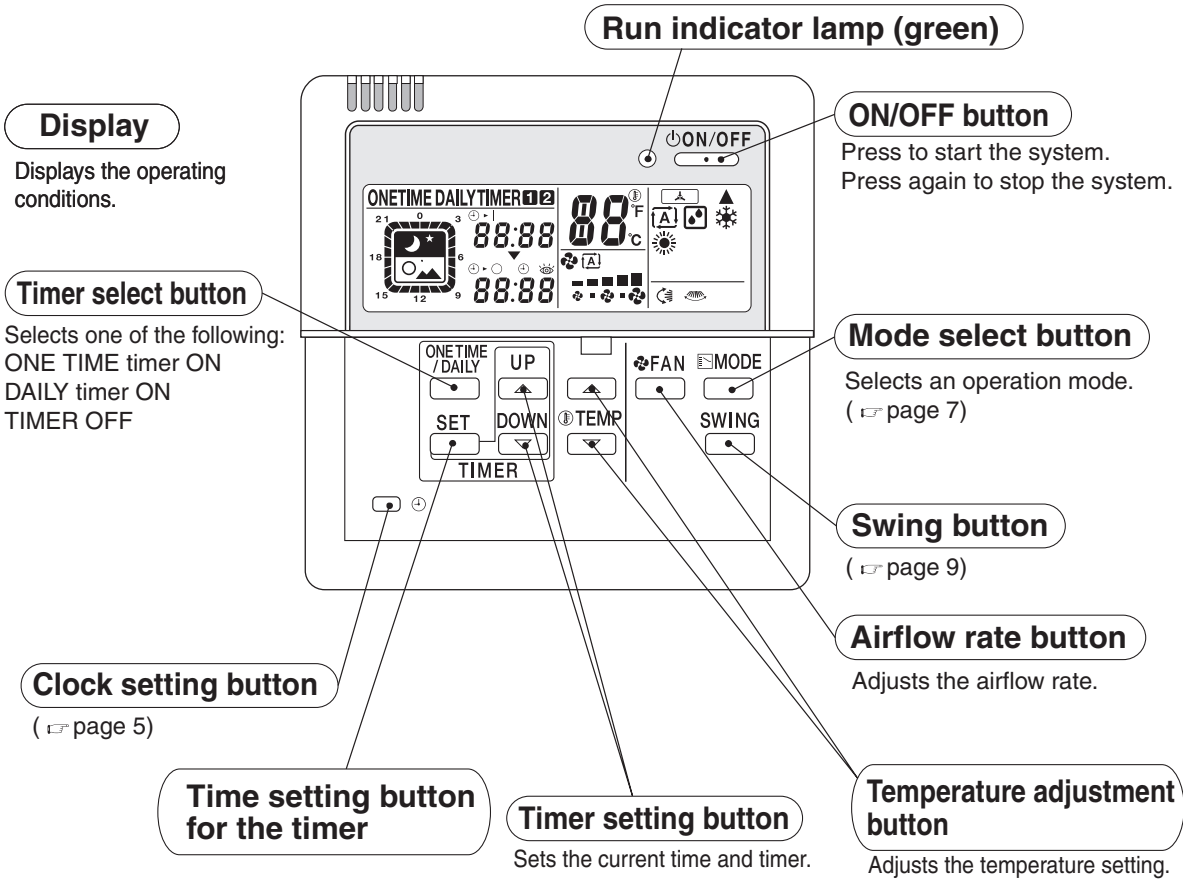

**CAUTION**

• This remote controller cannot be used together with a standard wireless remote controller. Otherwise, what appears on this remote controller's display may fail to correspond to actual operating conditions.

# Preparation before Operation

## ■ Checking the power

If nothing appears on the remote controller's display, turn on the circuit breaker.

## ■ Setting the current time

1 Press  .



The current time starts blinking.  
0:00 lights up.

2 Press  and set the current time.

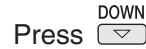

- Hold the button down to rapidly advance the time.

3 Press  .

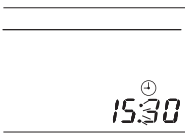

: blinks.  
(This completes the current time setting)

- The clock's accuracy is ±30 seconds per month.

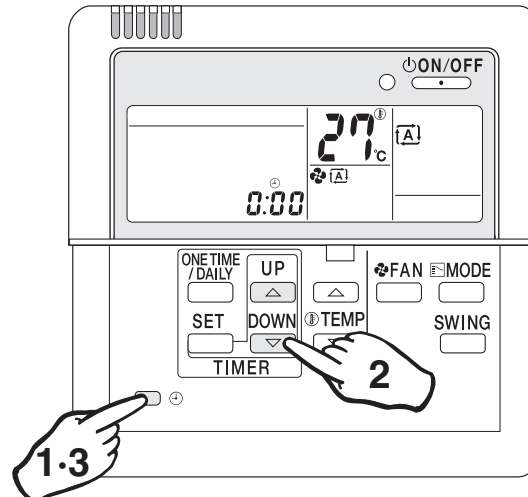

## Notes

### To use the unit efficiently

- Avoid overcooling or overheating. Moderate room temperature setting contributes to power saving.
 

Recommended temperature setting

For cooling ..... 26~28°C (79°F~82°F)

For heating ..... 20~22°C (68°F~72°F)
- Hang a blind or a curtain on the window. This will enhance the cooling/heating effect by intercepting direct sunlight and drafts.
- A clogged air filter reduces the cooling/heating effect and wastes energy. Clean the air filter monthly (every two weeks as required) or so.

### Please take note of the following points

- Electric power is consumed even when the air conditioner is not in operation.
- When the unit is not used for a long period of time such as during off-season, turn off the breaker.

### Operating conditions

- If the operation is continued under any conditions other than the following, the safety device may work to stop the operation. Also, dew may form on the indoor unit and drip from it. (Cooling/DRY)

Cooling	Outdoor temp.	-10 to 46°C (14°F to 115°F)
	Room temp.	18 to 32°C (64°F to 90°F)
	Indoor humidity	Less than 80%
DRY	Outdoor temp.	-10 to 46°C (14°F to 115°F)
	Room temp.	18 to 32°C (64°F to 90°F)
	Indoor humidity	Less than 80%
Heating	Outdoor temp.	-15 to 20°C (5°F to 68°F)
	Room temp.	Less than 27°C

- Operation limit differ according to the model.

# Preparation before Operation

## ■ Setting Temperature Indication change

Temperature indication can be changed between Celsius and Fahrenheit before use.

### To change from Celsius temperature indication to Fahrenheit one

- 1 Press and hold down  at the same time for 5 seconds while the Celsius temperature is indicated.

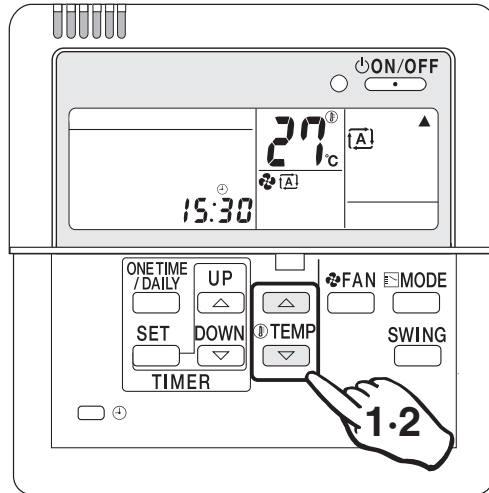
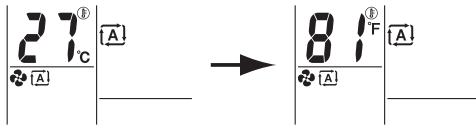

### To change from Fahrenheit temperature indication to Celsius one

- 2 Press and hold down  at the same time for 5 seconds while the Fahrenheit temperature is indicated.



## Notes

### ■ Temperature indication change between Celsius and Fahrenheit on the remote controller

- Change the temperature indication in the modes other than the DRY mode. In the DRY mode, temperature indication setting cannot be changed because the temperature is not indicated.
- When the Fahrenheit temperature indication is changed to Celsius one, the temperature value (0.5°C) will be rounded up. Thus, the preset temperature may be changed.

#### Example:

A preset temperature of 65°F (equivalent to 18.5°C) will be changed to 19°C (66°F) by changing the temperature indication. In this case, if you change the Celsius temperature indication again to the Fahrenheit one, the preset temperature is shown not as 65°F but as 66°F (equivalent to 19°C). If the preset temperature is 66°F (equivalent to 19°C) and is changed to the Celsius temperature indication, the indication becomes 19°C (66°F). In this case, no change by the temperature indication change is observed.

- When the temperature indication change is set, the preset temperature is transmitted to the indoor unit so that the reception sound will be heard from the indoor unit.

# Automatic·DRY·Cooling·Heating Operation

Select your desired operation mode.

Once preset, the system can get restarted in the same operation mode.

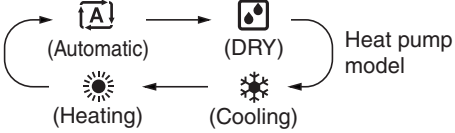
- 1** Press  to select your desired operation mode.
- Each time the button is pressed, the mode changes as follows.
- 

Heat pump model



Cooling only model
- The system does not have the FAN mode.

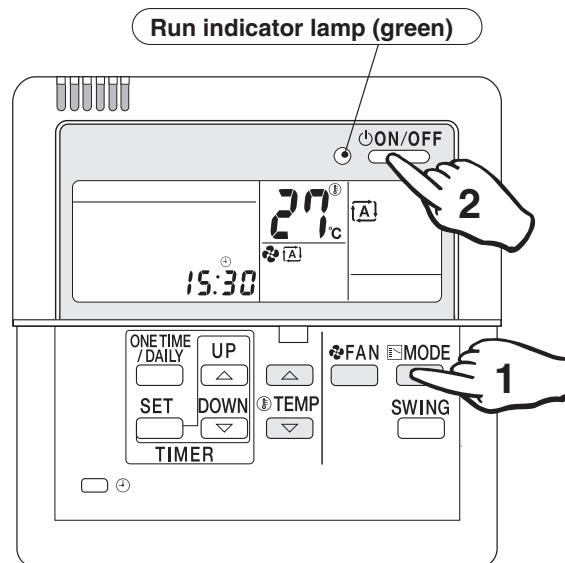

- 2** Press  .
- The run indicator lamp lights up.

## ■ To stop the operation:

Press  again.

The run indicator lamp goes out.

### Automatic operation

- In Automatic, the temperature setting and operation mode (DRY, Cooling or Heating) are automatically selected according to the room temperature and outdoor temperature at the time of starting operation.

### DRY operation





- In this mode, humidity is removed from the air.

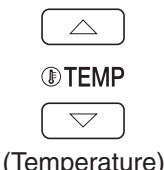
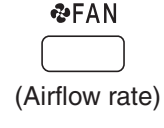

### Note

- While running in the DRY mode, you may feel cool or warm air from the air outlet. In this case, readjust the airflow direction with the vertical airflow direction louvers. (except Duct Connected type)

■ To adjust the temperature and airflow rate:

Setting to be adjusted / Operation mode	Automatic	Cooling	Heating	DRY
 (Temperature)	Temperature is adjustable. Recommended temperature Cooling : 26°C-28°C (79°F~82°F) Heating : 20°C-22°C (68°F~72°F)			Temperature cannot be adjusted.
 (Airflow rate)	Five levels of airflow rate setting from "  " to "  " plus "  " are available. 			Airflow rate cannot be adjusted.

- When the unit runs in the cooling or heating mode at a low airflow rate, the cooling or heating effect may be insufficient.

■ To adjust the airflow direction:

(  page 9)

**Heating operation**

- Since the heating operation is performed by taking the heat from outdoor into the room, the heating capacity decreases as the outdoor temperature lowers. If the room is not heated sufficiently, it is recommended to use other heating appliance at the same time.
- Since the air conditioner heats the whole room by circulating hot air, it takes some time to heat the entire room completely.
- If the outdoor unit gets frosted during heating operation, the heating capacity is decreased. In this case, the unit starts defrosting operation.
- No hot air comes out of the indoor unit during defrosting operation.



# Adjusting Airflow Direction

Adjust the airflow direction for maximum comfort.

## To adjust the Airflow Direction

- 1 Press  SWING during operation.
  - Each time the button is pressed, the airflow direction louvers change their movement.

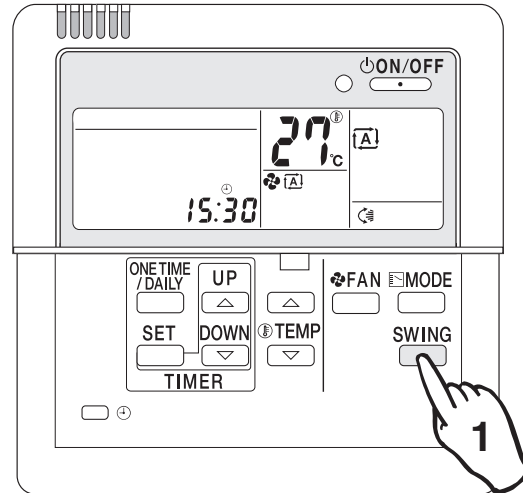

## ■ Wall Mounted Types (without horizontal swing function)

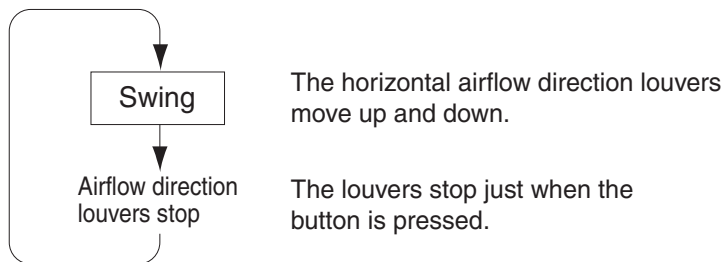

### Adjustment of horizontal airflow direction

- The automatic moving range of the horizontal airflow direction louvers varies depending on the operation mode.



#### Notes

- In fixing the horizontal airflow direction, keep the horizontal airflow direction louvers tilted downward in the heating mode, and keep them nearly horizontal level in the cooling or DRY mode. This will enhance the cooling and heating effect.
- On the air conditioners with vertical and horizontal swing function, be sure to adjust the airflow directions using the remote controller. Do not forcibly adjust louvers by hand or a malfunction may occur.

## ■ Wall Mounted Type (with horizontal swing function)

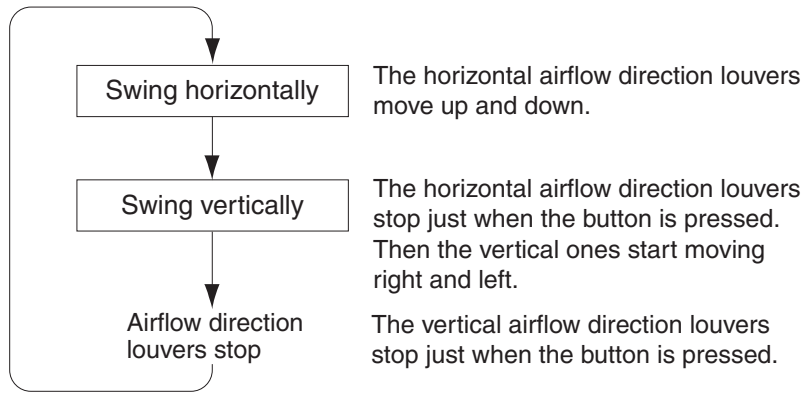

- The vertical and horizontal louvers cannot move at the same time.

## ■ Duct Connected Type (without swing function)

This function cannot be used.



### Note

- The operating procedure and remote controller display are different depending on the indoor unit being connected. Read **How to Adjust the Airflow Direction** in the air conditioner's Operation Manual.

# Timer Operation

The Timer Operation feature automatically turns off operation when you go to sleep and turns it back on when you wake up.

Use the DAILY Timer mode on weekdays, and the ONE TIME timer mode on weekends.

## ■ To select the ONE TIME timer mode:

- 1 Press  to select the ONE TIME timer mode.

- Each time the button is pressed, the modes change as follows.

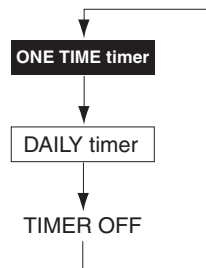

The timer lamp lights up.

## ■ To cancel the timer settings:

- 1 Press  to clear the timer settings.

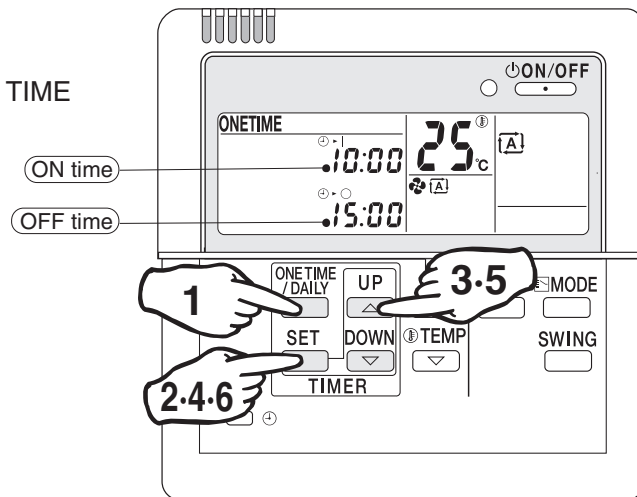
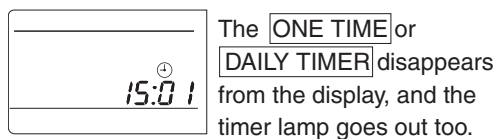

(Timer settings displayed)



## Notes

- Even when the timer has been off, its programmed settings are still in memory.
- If the system has the timer control ON but you start and stop it manually using the ON/OFF button before the designated ON time, the system will restart again at the programmed ON time.

### Precautions in setting the timer

- Before starting the timer operation, make sure the current time is correct. If not, set the clock correctly. (☞ page 5)
- In making time settings, --:-- is displayed to make it easy to disable the timer too.
- If one minute has passed before making any timer setting, the previous timer settings are reintroduced and the timer is on standby.



In this case, use the  (time setting) button and make your desired timer settings.

### Timer operation

- When the ON timer is programmed, the system starts one hour (maximum) earlier so that the temperature set by the remote controller is reached just in time.
- When the ONE TIME timer is programmed, the current time is no longer displayed.

### ■ ONE TIME timer

Once the timer has been activated and then deactivated, it is in the OFF mode. The ON or OFF timers can be programmed.

**1** Press  to select the ONE TIME timer. **4** Press .

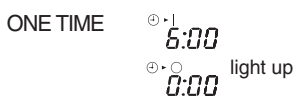
 light up.

**2** Press .

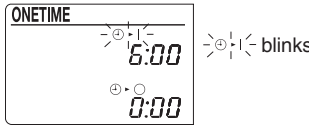
 blinks.

**3** Press  to make the ON timer setting.

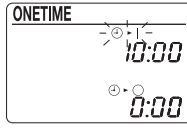
 When the ON timer is not used, save the setting as ①-| - - : - - .

- Each time the button is pressed, the setting changes in a 10-minute increment or decrement. Hold the button down to advance quickly.

**5** Press  to make the OFF timer setting.

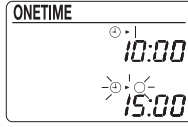
 When the OFF timer is not used, save the setting as ①-② - - : - - .

**6** Press  .  
(The ONE TIME timer is now programmed.)

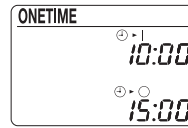
 Both of the ON and OFF time cannot be set as - - : - - .

#### Example of display with the ONE TIME timer programmed

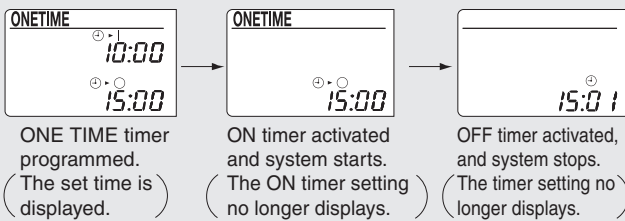

#### Notes

- In the following cases, reset the clock (the time setting is kept in the memory).
  - The circuit breaker has been activated.
  - The power fails.

# Timer Operation

## ■ To select the DAILY timer mode:

1 Press  to select the DAILY timer mode.

- Each time the button is pressed, the modes change as follows.

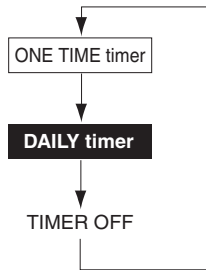

The timer lamp lights up.

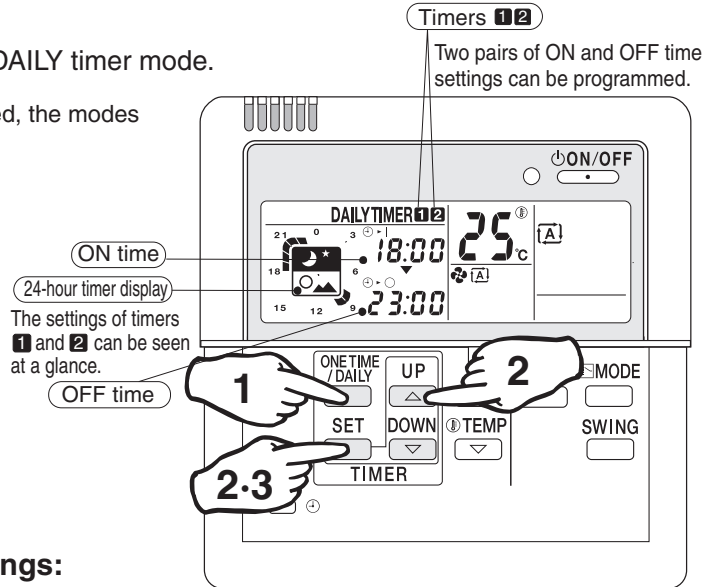

(Timer settings displayed)

## ■ To cancel the timer settings:

1 Press  to clear the timer settings.



The **ONE TIME** or **DAILY TIMER**, and the timer lamp are no longer displayed.

### Example of display with DAILY timer programmed

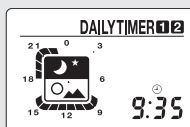

Timers **1** and **2** programmed.

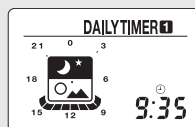

Timer **1** alone programmed.





### Note



- The system starts and stops repeatedly until the DAILY timer is set off. Before you leave home for a long time, set the DAILY timer off.

■ **DAILY timer**

After programming, the system starts and stops each day at the preset times. Two pairs of time settings can be programmed.

(Example: 8:00 ~ 10:00, and 18:00 ~ 23:00)

- 1 Press  to select the DAILY timer.  lights up. DAILY timer indication appears.
- 2 Make the ON and OFF time settings. • Take the steps from ① to ⑧.  
Program example: 8:00 ~ 10:00, and 18:00 ~ 23:00

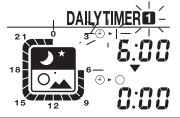
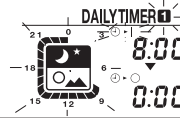
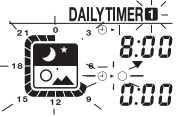
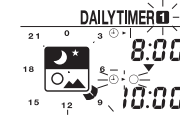
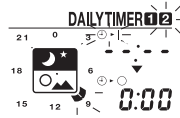
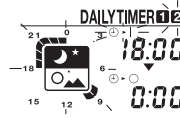
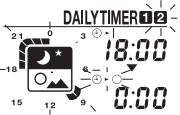
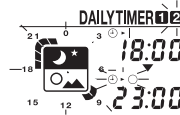
Settings		Procedure	
		Press 	Press  to make the timer setting. 
Timer 1	ON time setting • When the timer 1 is not used, save the setting as ①-①-①-①	① 	② 
	OFF time setting	③ 	④ 
Timer 2	ON time setting • When the timer 2 is not used, save the setting as ②-②-②-②	⑤ 	⑥ 
	OFF time setting	⑦ 	⑧ 

- 3 Press . The DAILY timer is now programmed.



**Note**

- If the following appears on the display, the timer must be reprogrammed.

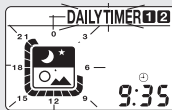

The 24-hour timer display is blinking.

This means that Timers 1 and 2 are programmed for the same time settings. New time settings must be made.

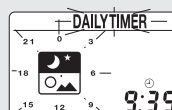

The 24-hour timer display is blinking.

This means that the timer has not been programmed yet.

# Cleaning

## Cleaning the remote controller

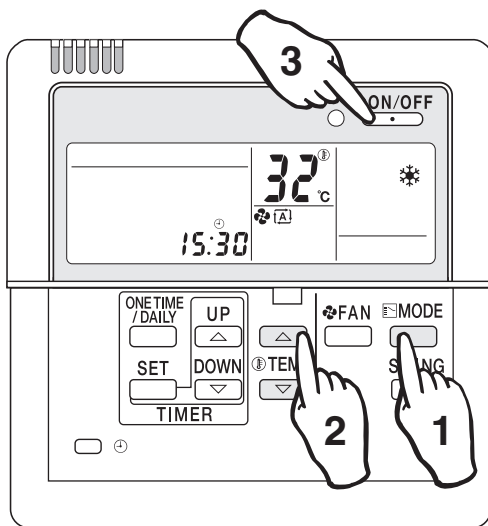

- Wipe it clean with soft, dry cloth.  
Do not use any water hotter than 40°C (104°F), or volatile liquids such as benzine, gasoline and thinner, polishing powder, or anything hard such as a scrub brush.

## When the unit is not used for a long time



- On a sunny day, keep the system running for half a day in the FAN mode to dry it up inside.

### FAN mode

- Press  to select the cooling mode.
  - Press  to adjust the set temperature to 32°C (90°F).
  - Press  .
    - The airflow rate remains the same, and is not adjustable.
    - Run the system when the room temperature is below 28°C (82°F).
- Finally turn off the circuit breaker dedicated for the room air conditioner.
  - Clean the air filter and place it back into position.

### 13.3 <BRP072A43> Wireless LAN Connection Adaptor

#### Safety Considerations

Give this installation manual to the customer when installation is completed.

- Read these **Safety Considerations** carefully to ensure correct installation.
- Be sure to complete trial operation of the air conditioner / heat pump, in advance, in accordance with the instructions in the installation manual for the air conditioner / heat pump.
- Meanings of **WARNING** and **CAUTION** symbols:
  - ⚠ WARNING** : Indicates a potentially hazardous situation which, if not avoided, could result in death or serious injury.
  - ⚠ CAUTION** : Indicates a potentially hazardous situation which, if not avoided, may result in minor or moderate injury. It may also be used to alert against unsafe practices.

**⚠ WARNING**

- Only qualified personnel must carry out the installation work. Installation must be done in accordance with this installation manual. Improper installation may result in electric shock, fire, or equipment damage.
- Use only specified accessories and parts for installation work. Failure to use specified parts may result in electric shock, fire, the product falling, or equipment damage.
- Before touching electrical parts, turn off the air conditioner / heat pump.
- Electrical work must be performed in accordance with relevant local and national regulations and with the instructions in this installation manual. Always use a dedicated circuit. Failure to comply may result in electric shock or fire.
- Do not disassemble, modify, or repair. Doing so may result in fire, electric shock, or injury.
- Do not handle this product with wet hands. Doing so may result in electric shock or fire.
- Do not allow this product to get wet or use it when bathing or similar activities using water. Failure to comply may result in electric shock or fire.





- Do not use this product near medical equipment or persons using cardiac pacemakers or defibrillators. This product may cause life-threatening electromagnetic interference.
- Do not use this product near auto-control equipment such as automatic doors or fire alarm equipment. Doing so may result in accidents due to malfunctioning.
- Immediately turn off the circuit breaker for the air conditioner / heat pump if there is an abnormal odor or sound, the unit is overheating, or smoke is emanating from the unit. There is a risk of fire or malfunction. Request an inspection by your dealer.
- Turn off the circuit breaker for the air conditioner / heat pump if the product was dropped or the case is damaged. There is a risk of fire or electric shock. Request an inspection by your dealer.
- Do not install the wireless LAN connection adaptor in the plenum of the building. Doing so may result in fire.

**⚠ CAUTION**

- Do not install this product where gas leakage could be exposed to open flames. If the gas leaks and builds up around the product, it may catch fire.
- Touch a nearby metal object (doorknob, aluminum sash, etc.) to discharge static electricity from your body before touching this set. Static electricity from your body can damage this set.
- Grip the connector when disconnecting the connection cord from the outlet. Otherwise fire or electric shock can occur.
- Do not use where small children can get access. There is a risk of injury to small children.

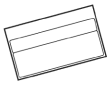
- Do not use this product near a microwave oven. This can affect wireless LAN communications.

#### Accessories

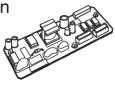
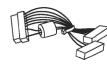
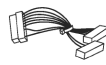
<p>Ⓐ Wireless LAN connection adaptor </p> <p style="text-align: right;">1</p>	<p>Ⓑ Serial number sticker *1 </p> <p style="text-align: right;">1</p>	<p>Ⓒ Installation manual (multi-language) </p> <p style="text-align: right;">1</p>
<p>Ⓓ Connection cord (1.6m) *2 </p> <p style="text-align: right;">1</p>	<p>Ⓔ Fastening tape </p> <p style="text-align: right;">1</p>	<p>Ⓕ Mounting screw </p> <p style="text-align: right;">2</p>
<p>Ⓖ Home automation printed-circuit board (HA PCB) *3 </p> <p style="text-align: right;">1</p>	<p>Ⓗ Harness (with ferrite core) *3 </p> <p style="text-align: right;">1</p>	<p>Ⓖ Harness (without ferrite core) *3 </p> <p style="text-align: right;">1</p>

\*1 Attach to the sticker attachment area on this document and keep safe.  
 \*2 Do not use extension or other cords.  
 \*3 Not used with air conditioners fitted with an S21 connector.

**[About the SSID and KEY]**

- The [SSID] and [KEY] shown on the Ⓑ serial number sticker are necessary when connecting the air conditioner and a smartphone via wireless LAN.

**[Sticker attachment area]**

Attach the Ⓑ serial number sticker to the sticker attachment area and keep safe.



## Names of Parts

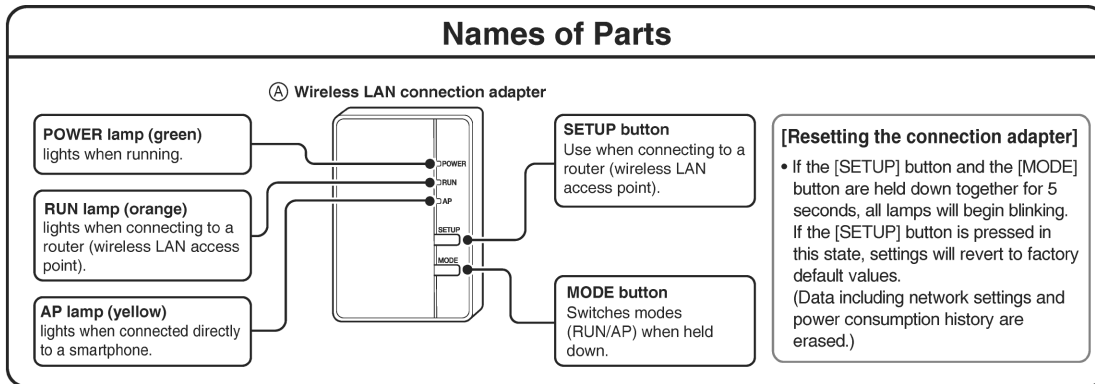

## Installation Position

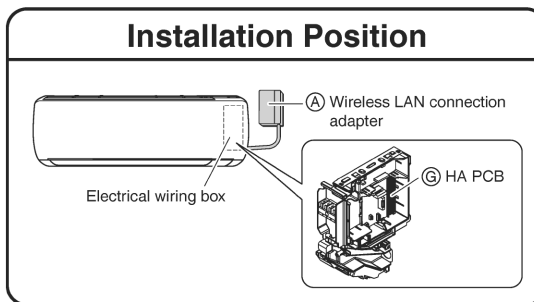

## Wiring Outline

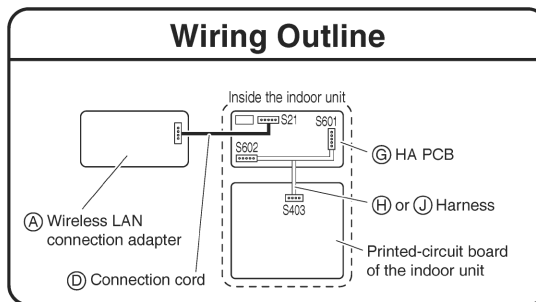

## HA PCB Installation Procedure (1)

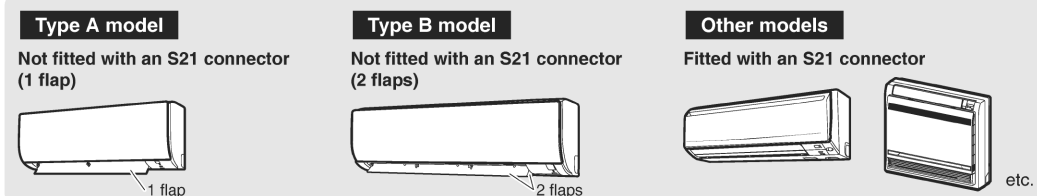

### ⚠ WARNING

Be sure to turn OFF the power at the time of installation work.  
Touching any electric parts with the power turned ON may cause electric shock.

1. Remove the front panel, service lid, and front grille in accordance with the installation manual for the air conditioner.

2. Install the **HA PCB**.

Installation procedures for the **HA PCB** differ by model type.  
Refer to the relevant section.

For **Type A model** ⇒ Proceed to “HA PCB Installation Procedure (2) **Type A**”

For **Type B model** ⇒ Proceed to “HA PCB Installation Procedure (2) **Type B**”

For **Other models** ⇒ Connect the **connection cord** to the S21 connector in accordance with the installation manual for the air conditioner.  
(It is not necessary to install the **HA PCB**.) After making the connection, return the front grille, service lid, and front panel to their original positions.

## HA PCB Installation Procedure (2)

Type A

### 3. Remove the electrical wiring box cover.

- Disengage the hooks to remove the electrical wiring box cover.

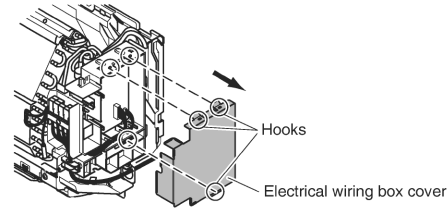

### 4. Remove the electrical wiring box (if necessary).

If there is workspace on the right-hand side of the indoor unit, the installation work can be conducted without removing the electrical wiring box. Connect the Ⓒ HA PCB without removing the electrical wiring box, if possible.

- 1) Disconnect the inter-unit wire.
- 2) Disconnect the fan motor connector (S200) and swing motor connector (S6).
- 3) Disconnect the thermistor and ground wire from the heat exchanger (2 screws).  
(Some models may not have ground wire.)
- 4) Remove the mounting screw of the electrical wiring box (1 screw).

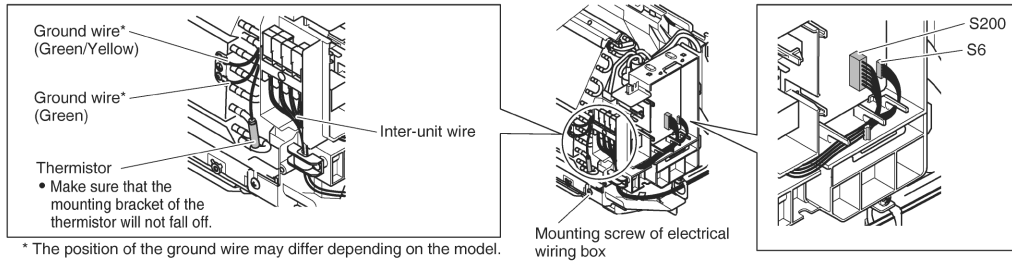

### 5. Install the HA PCB to the electrical wiring box.

- 1) Attach the Ⓓ harness (with ferrite core), by connecting it to the S601 and S602 connectors on the Ⓒ HA PCB. (See Fig. 2)
- 2) Insert the connector of the Ⓓ harness (with ferrite core) into the S403 connector on the electrical wiring box. (See Fig. 2)
- 3) Install the Ⓒ HA PCB to the electrical wiring box. (See Fig. 2)
- 4) Insert the Ⓔ connection cord into the S21 connector (white) on the Ⓒ HA PCB. (See Fig. 3)
  - Insert the connector of the Ⓔ connection cord without the cord anchor. (See Fig. 1)
- 5) Route the Ⓔ connection cord as shown in the figure. (See Fig. 3)

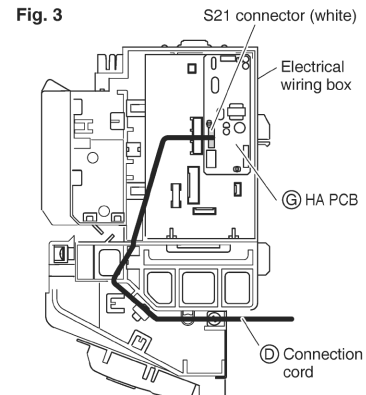
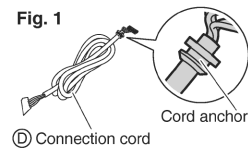
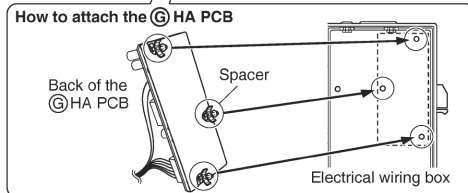
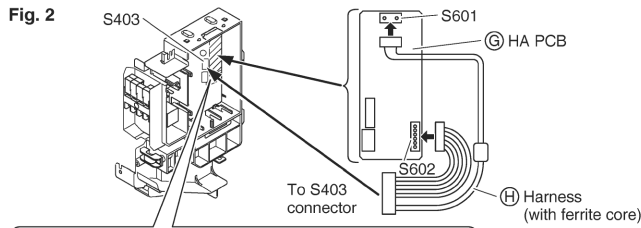

### 6. Return the electrical wiring box cover and electrical wiring box (if it was removed) to their original positions.

### 7. Return the front grille, service lid, and front panel to their original positions in accordance with the installation manual for the air conditioner.

## HA PCB Installation Procedure (2)

Type B

### 3. Remove the electrical wiring box cover.

- Disengage the hooks to remove the electrical wiring box cover.

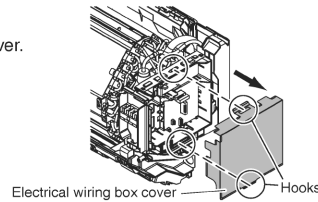

### 4. Remove the electrical wiring box (if necessary).

If there is workspace on the right-hand side of the indoor unit, the installation work can be conducted without removing the electrical wiring box. Connect the ⑥ HA PCB without removing the electrical wiring box, if possible.

- Disconnect the inter-unit wire.
- Disconnect the fan motor connector (S200) and swing motor connector (S6).
- Disconnect the thermistor and ground wire from the heat exchanger (2 screws).  
(Some models may not have ground wire.)
- Remove the mounting screw of the electrical wiring box (1 screw).

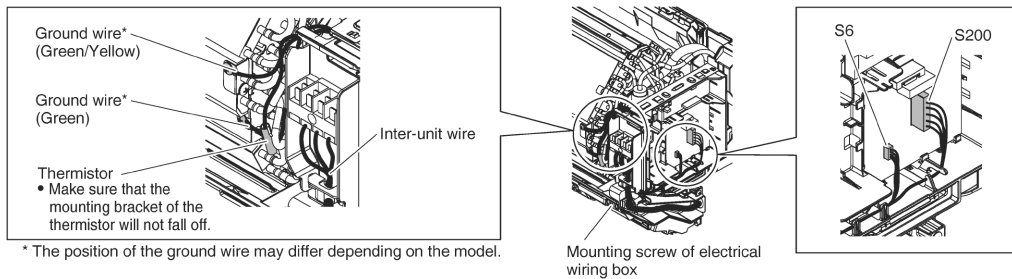

### 5. Install the HA PCB to the electrical wiring box.

- Attach the ④ harness (without ferrite core), by connecting it to the S601 and S602 connectors on the ⑥ HA PCB. (See Fig. 2)
- Insert the connector of the ④ harness (without ferrite core) into the S403 connector on the electrical wiring box. (See Fig. 2)
- Install the ⑥ HA PCB to the electrical wiring box. (See Fig. 2)
- Insert the ⑤ connection cord into the S21 connector (white) on the ⑥ HA PCB. (See Fig. 3)
  - Insert the connector of the ⑤ connection cord without the cord anchor. (See Fig. 1)
- Route the ⑤ connection cord as shown in the figure. (See Fig. 3)

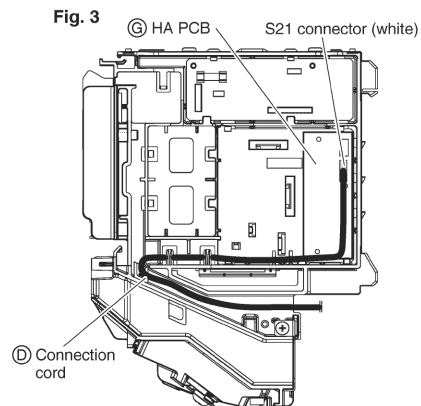
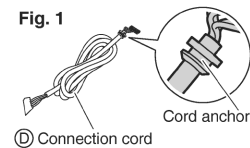
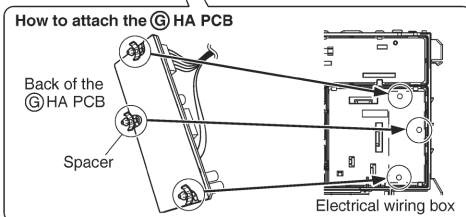
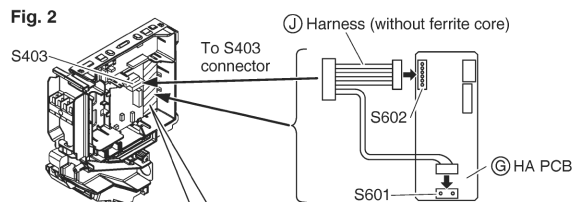

### 6. Return the electrical wiring box cover and electrical wiring box (if it was removed) to their original positions.

### 7. Return the front grille, service lid, and front panel to their original positions in accordance with the installation manual for the air conditioner.

## Wireless LAN Connection Adapter Installation Procedure All types

The following procedures are also applicable to air conditioners fitted with an S21 connector.

### 1. Remove the upper case of the (A) wireless LAN connection adapter.

Press a slot-head screwdriver\* into the dent between the upper and lower cases of the (A) wireless LAN connection adapter to remove. (Be careful not to damage the case.)  
\* Use a slot-head screwdriver with a wide head (0.2 inches (5mm) or wider is recommended).

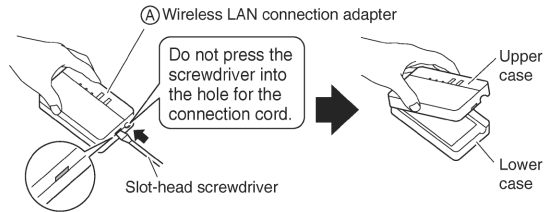

### 2. Attach the (D) connection cord to the (A) wireless LAN connection adapter.

- 1) Attach the connector of the (D) connection cord.
- 2) Fasten the (D) connection cord to the notch in the lower case of the (A) wireless LAN connection adapter.

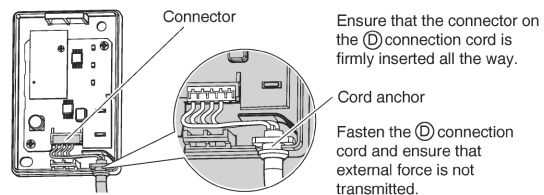

### 3. Install the lower case of the (A) wireless LAN connection adapter to a wall, a pillar, or similar location.

- Install the lower case so as to allow the upper case to be easily removed for maintenance purposes.
- Do not install outdoors or anywhere it is likely to get wet.
- Do not install it near the sensor part of the indoor unit.

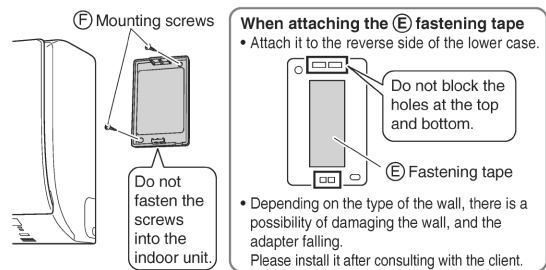

### 4. Return the adapter case to its original condition.

Close the adapter by hooking the top of the upper case on the top clip of the lower case.

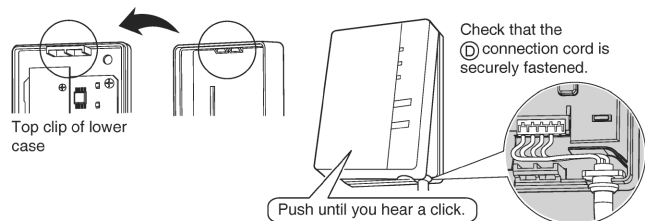

### 5. Turn on the power supply, wait until the initialization is complete, and check that the [POWER] lamp of the (A) wireless LAN connection adapter lights up.

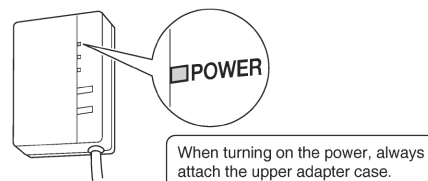

## Preparation Before Configuring Connection Settings

All types

The customer is responsible for providing the following.

- Smartphone or tablet PC  
(Supported OS: Android 4.0.3 or later; iOS 7.0 or later.)
- Internet line and communicating device  
(Modem/router or a similar device)
- Wireless LAN access point  
(The corresponding channel for the wireless LAN connection adapter is 1-11.)
- [DAIKIN Mobile Controller] (No Cost)

### Installation method of online controller

For Android Phones/Tablets	For iPhones/iPads
(1) Open the [Google Play].	(1) Open the [App Store].
(2) Search for [Daikin Comfort Control].	(2) Search for [Daikin Comfort Control].
(3) Follow the directions on the screen to install.	(3) Follow the directions on the screen to install.

## Configuring Connection Settings (1)

All types

Check whether the router to be used supports WPS.

If WPS is supported ⇒ Proceed to **Simple setup**

If WPS is not supported ⇒ Proceed to **Advanced setup**

### Simple setup

#### 1. Check that the [POWER] lamp is continuously lit and the [RUN] lamp is blinking.

- If the [POWER] lamp is lit and the [RUN] lamp is not lit, hold down the [MODE] button on the adapter for about 2 seconds to prompt the [RUN] lamp to begin blinking. (Blinking begins in about 30 seconds.)

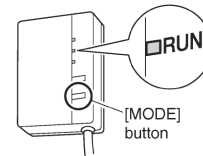

#### 2. Press the [WPS] button on the router (wireless LAN access point).

- Operation procedures for the [WPS] button vary by router (wireless LAN access point). For details, refer to the instruction manual for the router.

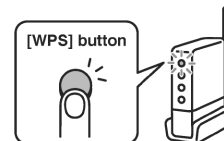

#### 3. Hold down the [SETUP] button on the adapter for about 2 seconds.

- The [RUN] lamp will begin to blink more rapidly, and will change to a continuous light once a connection between the router (wireless LAN access point) and the adapter has been established.

If a connection fails to establish, repeat procedures from step 1 of "Simple setup".

If a connection still cannot be established, follow the procedures in "Advanced setup".

(In some cases, a connection cannot be established using the steps in "Simple setup" owing to compatibility issues.)

#### 4. Connect the smartphone (tablet PC) and the router (wireless LAN access point).

- A connection can be established by opening the smartphone's Wi-Fi network list, selecting the [SSID] for the router and entering its password.

#### 5. Tap the installed app [Daikin Comfort Control] to start it.

- If the connected air conditioner is listed in the units overview screen, setup is complete. If it is not listed, tap  (refresh) in the top right corner of the units overview screen.

### Note

- If an upgrade is available for your adapter, the notification icon  will be displayed on the units overview screen. Tap it to upgrade your firmware.



## Configuring Connection Settings (2)

All types

**Advanced setup** • All steps are demonstrated using iOS.

1. Check that the [AP] lamp is lit (continuously).  
If the [AP] lamp is not lit, hold down the [MODE] button on the adapter for about 2 seconds to prompt the [AP] lamp to light up (continuously). (Lights in about 10 seconds.)

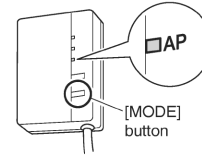

2. Connect the smartphone (tablet PC) directly with the adapter via wireless LAN.

- Open the smartphone's Wi-Fi network list, select the [SSID] (DaikinAP \*\*\*\*\*) shown on the ② serial number sticker, or the ① wireless LAN connection adapter, and then enter the [KEY].

3. Tap the installed app [Daikin Comfort Control] to start it.

4. Make the wireless connection settings.



(1) Tap [Configure the wireless connection].



(2) Select your home network from the list.

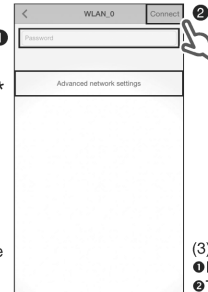

(3) ① Enter the password.  
② Tap [Connect].

- (4) Follow the on-screen instructions from here onward to complete setup.

- (5) After implementing the setting above and the product and router (wireless LAN access point) are connected, the [RUN] lamp will light. If this blinks for 1 minute or longer, check the power to the router (wireless LAN access point), network name and the password and start again from the first procedure.

- \* To set the wireless connection manually, tap [Advanced network settings], turn off [Automatic IP address (DHCP)], fill in the required information for the Wi-Fi router, tap [✓] and then tap [Connect] on the wireless connection screen. Follow the on-screen instructions and then continue as in step (5).

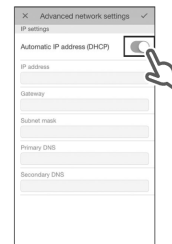

5. Connect the smartphone (tablet PC) and the router (wireless LAN access point), and then start [Daikin Comfort Control].

- Refer to step 4 and step 5 of "Simple setup".

### Troubleshooting

The following table provides brief descriptions of how to handle problems or uncertainties when you install the product or make connection settings. Check our website for details.

**URL**  
<http://daikincomfort.com/DuctlessWireless/FAQ>



• FAQ can be viewed via smartphone (tablet PC). To access, please scan the 2D barcode.

When this happens	Explanation and where to check
[RUN] lamp does not light up (continuously).	The [RUN] lamp blinks. → Perform Simple setup or Advanced setup again. → Check that the [SSID] and password for the adapter are entered correctly. → Move the router (wireless LAN access point) closer to the adapter. → The smartphone or router (wireless LAN access point) in use may not be supported. Check our website for details.

### After-sale Service

For inquiries concerning after-sale service, contact your dealer and advise them of the following details:

- Model name
- Date of installation
- Conditions at the time of failure (as precisely as possible)
- Your address, name, and telephone number

This telecommunication equipment is in compliance with FCC/IC requirements.

<p><b>FCC CAUTION</b>                      Changes or modifications not expressly approved by the party responsible for compliance could void the user's authority to operate the equipment.</p>
<p>This transmitter must not be co-located or operated in conjunction with any other antenna or transmitter.</p>
<p>This device complies with Part 15 of FCC Rules and Industry Canada license-exempt RSS standard(s). Operation is subject to the following two conditions: (1) this device may not cause interference, and (2) this device must accept any interference, including interference that may cause undesired operation of this device.</p>
<p>This equipment complies with FCC/IC radiation exposure limits set forth for an uncontrolled environment and meets the FCC radio frequency (RF) Exposure Guidelines and RSS-102 of the IC radio frequency (RF) Exposure rules. This equipment should be installed and operated keeping the radiator at least 8 inches (20cm) or more away from person's body.</p>

Contains FCC ID:VPYLBYD  
 Contains IC: 772C-LBYD

## 13.4 <KRP413AB1S> Wiring Adaptor for Timer Clock / Remote Controller

### Safety Precautions

- Read these safety precautions carefully before installing the unit, and be sure to install the unit properly.
- This manual classifies precautions to the user into the following two categories. These warnings and cautions are for your safety. Follow them.

<b>⚠ WARNING</b>	Faulty installation can result in death or serious injury.
<b>⚠ CAUTION</b>	Faulty installation can result in serious injury, damage to property, or other serious consequences.

- After installation is complete, test the unit to confirm that it is working properly, and instruct the owner its proper use.

### ⚠ WARNING

- Installation should be left to the dealer from whom you purchased the unit, or another qualified professionals.
- Install the unit securely according to the installation manual. Faulty installation may lead to electric shock or fire.
- Be sure to use the supplied or specified parts. Using other parts may lead to electric shock or fire.
- Install the unit securely in a location that will support its weight. If installed in a poor location or improperly installed, the unit may not work as intended.
- For electrical work, follow local electric standards and the installation manual. Faulty installation may lead to fire or electric shock.
- Do not bundle the power cord, or attempt to extend it by splicing it with another cord or by using an extension cord. Do not place any other load on the power circuit used for the unit. Improper wiring may lead to electric shock, heat generation or fire.
- Use dedicated wiring for all electrical connections, and be sure to arrange the wiring so that force applied to the wiring will not damage the terminals. Poor wiring or installation may cause electric shock, heat generation or fire.

### ⚠ CAUTION

- Before installation, unplug the air conditioner to ensure safety. Failure to do so may cause electric shock.
- Static electricity may damage electric components. Before connecting cables and communication lines, and operating the switches, be sure to discharge any electrical charge from your body (by, for example, touching the earth line)
- Do not install the unit in a location where it may be exposed to flammable gases. If gas leaks and build up around the unit, it may catch fire.
- Do not place the wiring close to the power cord, inter-unit cable, or pipes which generate noise. Treat the wiring with care.

### 1. Functions and Features

- On/Off setting
- Switching between Instantaneous Contact/Normal Contact
- Connection with five-room central controller (KRC72 for oversea model)
- Connection with fan coil remote controller
- Automatic reset after power failure
- Output of normal operation signals/malfunction signals

### 2. Field Wiring

For interconnecting wiring, use Daikin KDC100A12 cable (not supplied) or other similar cable. Use a vinyl-covered wire or cable with four conductors each with a thickness of 0.2 to 1.25 mm<sup>2</sup>.

#### ■ Optional cable KDC100A12 (without connectors)

Specifications: 0.2 mm<sup>2</sup> × 4 core (sheathed)  
 Outer diameter: φ5.3  
 Length: 100 m  
 Colour: Grey

Note : Keep any wiring for the control unit away from the power cord to prevent electrical noise.

## Installation ①

### 1 Installation diagram

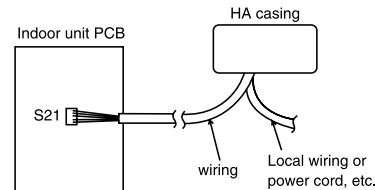

### 2 Components

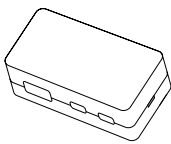
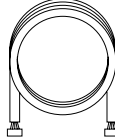
①HA casing ASSY (Remote Control PCB is attached in the HA casing.) 	②Wiring (approx. 0.8 m) 
③Accessories Binding band (6 pcs.) • Screws for attaching to the wall (3 pcs.)	
④Installation manual	



## Installation ②

### Attaching HA Case ASSY

- Use the 3 supplied screws to attach the HA casing ASSY.

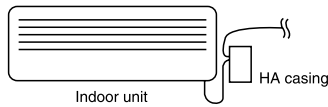

Install the HA casing ASSY as close to the indoor unit as possible.

#### ① Removal of upper HA casing

- (1) Insert a flat-blade screwdriver into the groove between the upper and lower HA casings.

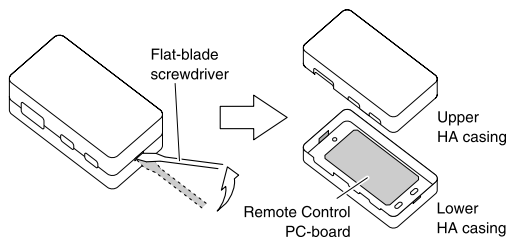

- (2) Lift the handle of the screwdriver upward.

- (2) Mount and secure the lower HA casing directly on the wall with the provided screws inserted into the screw holes (a round hole and two ellipse holes) of the casing.

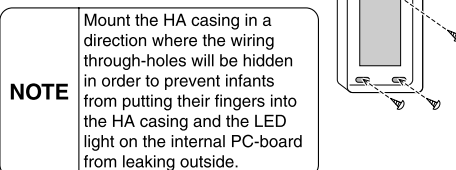

- (3) After connecting the cables (refer to the following sections), replace the case front. Be careful not to damage the wiring in the case.

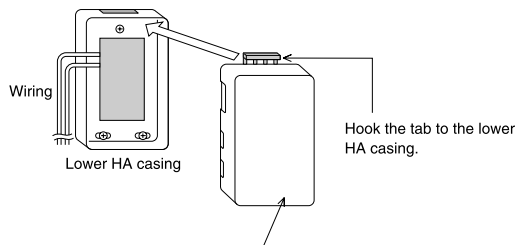

Press the lower part of the upper HA casing and press fit it onto the lower HA casing.  
Press the upper HA casing precisely until a clicking sound is heard.

## Wiring ①

### 1. Wiring

- ① Connect one end of the wiring to connector S21 of the PCB in the indoor unit.
- ② Connect the other end of the wiring to connector S6 of the Remote Control PCB.
- ③ Connect field wiring according to the functions assigned to each connection terminal of the Remote Control PCB.
- ④ Secure all wires.

#### 1 Securing wires in the HA casing ASSY

##### ① Connection of wiring

Connect the wiring to the connector terminals.

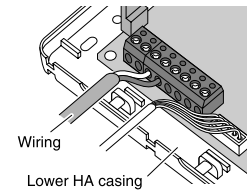

##### ② Fixation of wiring

- (1) Insert the provided binding band under the pillar of the HA casing and secure the covers of the wiring with the binding band.

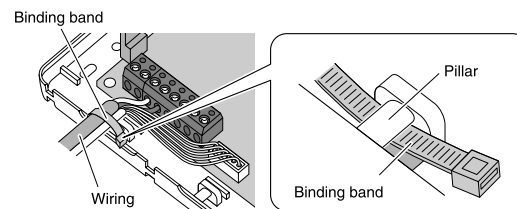

- (2) Insert the second binding band into the groove on the side of the HA casing and fix the wiring securely so that the wiring will not be disconnected.

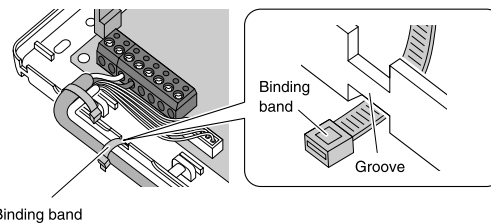

#### A large number of wires

Make a slit with an appropriate tool, such as a cutter knife, on the thin part of the upper HA casing along the frame. Then cut the part with an appropriate tool, such as a pair of rippers.

(NOTE) Cut off only the thin part required for wiring.

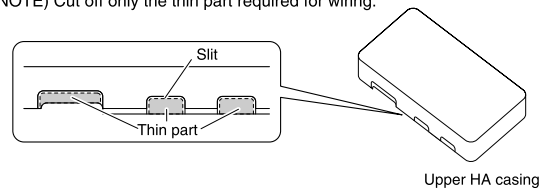

#### 2 Securing wires in the indoor unit

- The method for securing wire varies depending on the model of the air conditioner. See your air conditioner installation manual for details.

## Wiring ②

### 2. Automatic Reset After Power Failure

- This PCB stores the following data in the event of a power failure (the storage period is limitless).
    - ① On/Off (see Note 1)
    - ② Operation modes (see Note 2)
    - ③ Temperature setting
    - ④ Air flow rate
    - ⑤ On/Off status of remote controller
- (Note 1 When SW1-2 is in Off mode, the unit will not be activated.)  
 (Note 2 The following settings apply to the models below.)

Mode before the power outage	COOLING	HEATING
Room air conditioner		
Models with Humid heating and Reheating dehumidifying functions.	DRY COOLING	HUMID HEATING
Models with Reheating dehumidifying function.		HEATING

(Note 3 Not all settings will be saved (e.g., humidity or swing settings will not be saved).)

### 3. Monitor Signal Output (normal operation and malfunction)

- Maximum length of the wiring is 100 m. No external power supply is required.

#### 1 Monitor signal output for LED

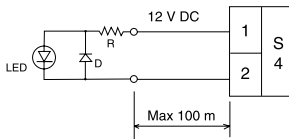

#### Locally procured parts

Item	Manufacturer	Type
LED	Rohm	SLR-342
D	Rohm	1SS133
R		510 ohm 1/4W

#### 2 Monitor signal output (normal operation and malfunction) using external relay contacts

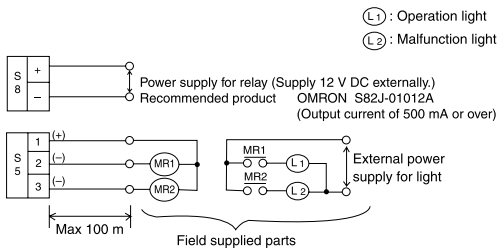

#### Field procured parts (Recommended external relay contacts)

Manufacturer	Type	Coil rated voltage	Coil resistance
Omron	MY relay	12 V DC	160 ohm ± 10%
Panasonic	HC relay	12 V DC	160 ohm ± 10%

### 4. Connection with Remote Controller

Example connections with three kinds of remote controllers are shown below. Note: These connections cannot be used in combination.

#### 1 Remote control with switch (field supply)

- Set SW1-1 to Off and select Operation Mode 1.



##### <Instantaneous Contact>

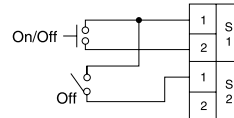

- The remote controller most recently used (local or air conditioner) takes precedence.
- Use a remote controller with a pulse width of 100 msec or more.

##### <Normal Contact>

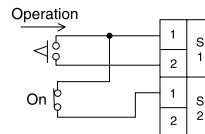

- Power On/Off cannot be controlled from the unit's remote controller. (Three beeps for signal reception will be heard continuously when the wireless remote controller is operated.)
- When power is restored after a power failure in this mode, On or Off is determined according to the current settings of the remote controller.

#### 2 Five-room central controller (KRC72)

- Set SW1-1 to Off and select Operation Mode 1.
- The remote controller most recently used takes precedence.

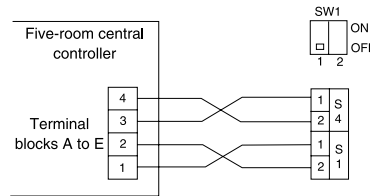

#### 3 Fan coil remote controller

- Set SW1-1 to On and select Operation Mode 2.
- Most settings (power On/Off, air flow rate, mode change) cannot be made using the air conditioner's remote controller.
- When power is restored after a power failure in this mode, On or Off is determined according to the current settings of the remote controller.
- When the Cooling/Heating mode is changed, use the air conditioner's remote controller to adjust the temperature.

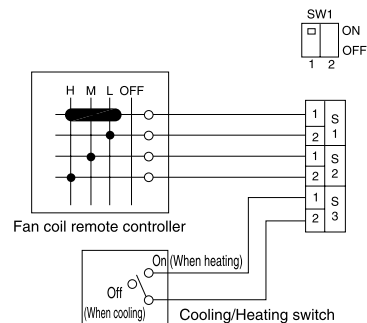

## Test Operation and Confirmation

### 1. When the System is Not Working

- Is the air conditioner working properly?
- Are the connectors of the wiring properly connected?
- Are the remote controller and field wiring properly connected?
- Are all switch settings correct?
- If there is nothing apparently wrong, conduct a diagnostic check using the following procedure.

■ Diagnostic check

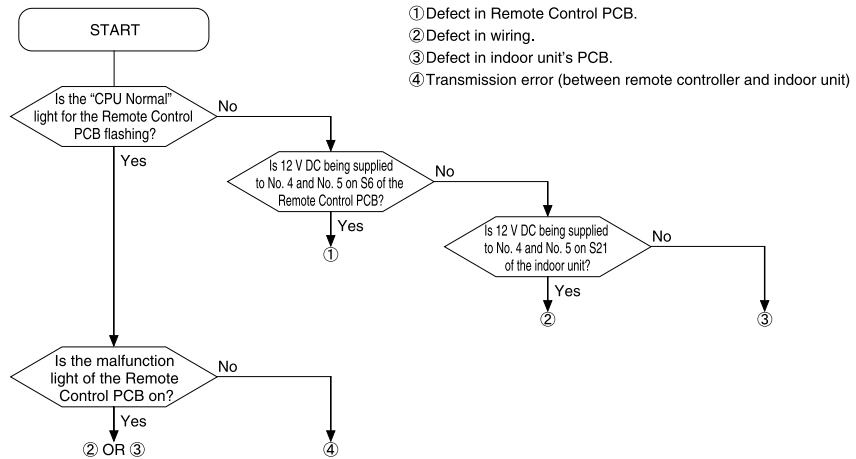

### 2. Switch Settings and Connection Terminals

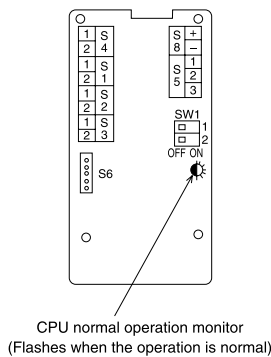

SW1-1	Selecting the operation mode	OFF	Operation mode 1 (Used with the exception of fan coil remote controller settings)		
		ON	Operation mode 2 (Used with fan coil remote controller settings)		
SW1-2	Selecting On/Off when power is restored after a power failure	OFF	Always Off		
		ON	Off if operation was in Off mode before power failure; On if operation was in On mode before power failure		
S1 S2 S3	SW1-1: OFF (Operation mode 1)		Instantaneous contact	Normal contact	
		S1 (1) - S2 (1)	OPEN	CLOSE	
		S1 (1) - S1 (2)	Pulse input On/Off switching		OPEN, Not activated CLOSE, Activated
		S2 (2), S3	Not used		
		S1, S2 OPEN	Not activated		
	SW1-1: ON (Operation mode 2)	S1 (1) - S1 (2) CLOSE	On, airflow: L tap		
		S1 (1) - S2 (1) CLOSE	On, airflow: M tap		
		S1 (1) - S2 (2) CLOSE	On, airflow: H tap		
		S3 (With the remote controller only)	OPEN	Cooling	
			CLOSE	Heating	
S4	(1) - (2)	Voltage on (12 V DC), normal operation light output			
S5	(1) - (2)	Normal operation light output (power for light required)			
	(1) - (3)	Malfunction light output (power for light required)			
S6 connector		Connect with connector S21 on the PCB of the indoor unit			
S8	(+) - (-)	Relay 12 V DC power supply terminal (Field supplied parts)			

# 13.5 <KRP928BB2S> Interface Adaptor for DIII-NET (Residential Air Conditioner)

## Safety Precautions

- Read these Safety Precautions carefully to ensure correct installation. This manual classifies precautions into WARNING and CAUTION.
  - WARNING** : Failure to follow WARNING is very likely to result in such grave consequences as death or serious injury.
  - CAUTION** : Failure to follow CAUTION may result in serious injury or property damage, and in certain circumstances, may result in a grave consequence.
- Be sure to follow all the precautions below ; they are all important for ensuring safety.

**WARNING**

- Installation should be left to the dealer or another qualified professional.**  
Improper installation by yourself may cause malfunction, electrical shock, or fire.
- Install the set according to the instructions given in this manual.**  
Incomplete or improper installation may cause malfunction, electrical shock, or fire.
- Be sure to use the standard attachments or the genuine parts.**  
Use of other parts may cause malfunction, electrical shock, or fire.
- Disconnect power to the connected equipment before starting installation.**  
Failure to do so may cause malfunction, electrical shock, or fire.
- A ground fault circuit interrupter / an earth leakage circuit breaker should be installed.**  
If the breaker is not installed, electrical shock may occur.

**CAUTION**

- Do not install the set in a location where there is danger of exposure to inflammable gas.**  
Gas accumulated around the unit at the worst may cause fire.
- To prevent damage due to electrostatic discharge, touch your hand to a nearby metal object (doorknob, aluminum sash, etc.) to discharge static electricity from your body before touching this kit.**  
Static electricity can damage this kit.
- Lay this cable separately from other power cables to avoid external electrical noises.**

- After installation is complete, test the operation of the PCB set to check for problems, and explain how to use the set to the end-user.

## 1.Overview, Features and Compatible Models

This kit is the interface required when connecting the central controller and a Room Air Conditioner. Use of the central controller makes it possible to perform the following monitoring and operations. It is compatible with room air conditioners which have an HA connector S21.

- Run / stop for the central controller and wired remote controller, operating mode selection, and temperature can be set.
- The operating status, any errors, and the content of those errors can be monitored from the central controller and wired remote controller.
- Run / stop for the central controller and wireless remote controller, operating mode selection, and the temperature setting can be limited by the central controller.
- Zone control can be performed from the central controller.
- The unit can remember the operating status of the air conditioner before a power outage and then start operating in the same status when the power comes back on.
- Card keys, operating control panels, and other constant / instantaneous connection-compatible equipment can be connected.
- The Operating / error signals can be read.
- The indoor temperature can be monitored from the Intelligent Touch Controller.

- Precaution
- When reading the Operating / error signals, a separate external power source (12 V DC) is needed.
  - A separate timer power source (16 V DC) is needed when using the schedule timer independently, and not in conjunction with other central controllers.
  - The range of temperatures that can be set from the central controller is 18°C to 32°C in cooling and 14°C to 28°C in heating.
  - Fan operation cannot be selected from the central controller or wired remote controller.
  - Group control (i.e., control of multiple indoor units with a single remote controller) is not available.
  - Monitoring is not available of the thermo status, compressor operating status, indoor fan operating status, electric heater, or humidifier operating status.
  - Forced thermo off, filter sign display and reset, fan direction and speed settings, air conditioning fee management, energy savings instructions, low-noise instructions, and demand instructions cannot be made.

## 2.Component Parts

This kit includes the following components. Check to ensure that none of these are missing.

Parts	Q'ty	Parts	Q'ty
Kit assy PCB is in the housing.	1	Connection harness (about 1.6m)	1
		Mounting screws	3
		Binding band	6
		Installation manual	2

## 3.Names of Parts and Electric Wiring

### <Wiring procedure>

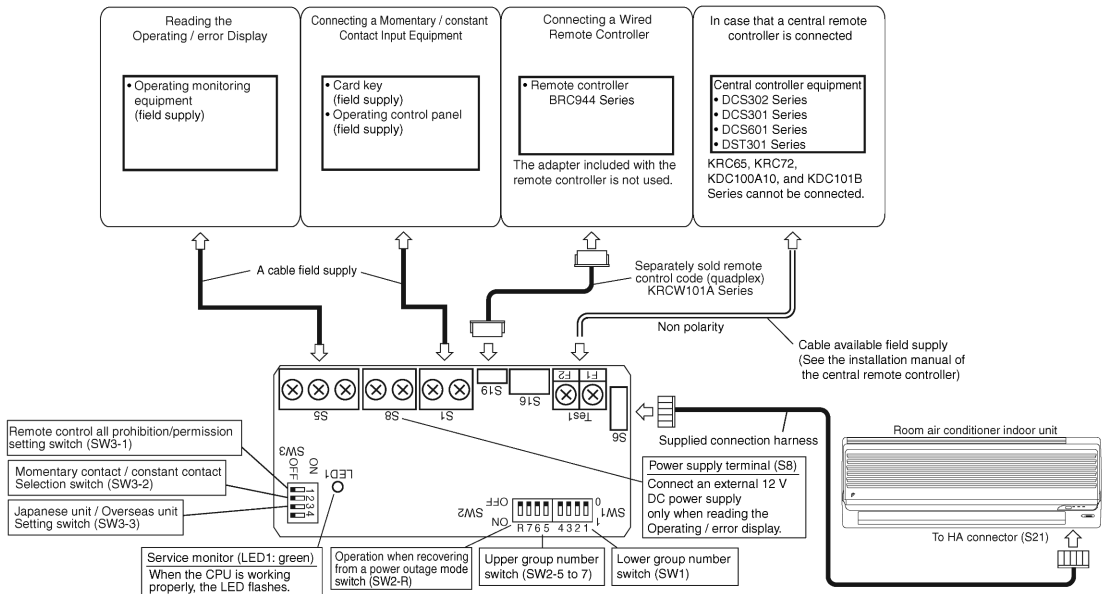

### 4. Switch Settings

**NOTE** Turn the power on after all the switches have been set. Settings made while the power is on are invalid.

Open the Kit's case and set the switches on the circuit board.  
 (1) For Overseas / Japanese unit setting (SW3-3)  
 Room air conditioners, different methods are used for setting the temperature in automatic mode, so this switch needs to be set.

Destination	SW3-3 setting	What Happens
Japan	OFF (Factory setting)	• "Automatic" operation is not available from the central controller. When using "automatic" operation using the wireless remote controller, the central controller displays automatic cooling (heating) and 25°C. Even if the temperature is changed, it will return to 25°C after a while.
Overseas	ON	• "Automatic" operation is available from the central controller.

(2) Group number settings (SW1 and SW2-5 to SW2-7)  
 Set these when using the central controller. (Set to the **side**.) Do not set more than one unit to the same number.  
 Use SW2-R for (3) Settings when recovering from a power outage.

However, these settings do not need to be made when using the schedule timer independently.  
 (The settings are needed when used in conjunction with another DCS Series central controller.)  
 In this case, the schedule timer performs an auto address after the power is turned on, so new group numbers are automatically set. Settings made using the switches will be overwritten.

Group NO. Settings table (Enlarged section SW1 and SW2 in "3. Names of Parts and Electrical Wiring")

Group NO. Upper settings SW2		Group NO. Lower settings SW1			
1	5	00	04	08	12
2	6	01	05	09	13
3	7	02	06	10	14
4	8	03	07	11	15

Use with power failure recovery settings Set to the **side**  ON  OFF

**NOTE** also that a separate timer power source is needed when using the schedule timer independently.  
 Power source specs: 16 V DC, +10%, -15%, 200mA.

(3) Settings when recovering from a power outage (SW2-R)  
 This selects whether to restart operation when the power comes back on after a power outage occurred during operation. This setting is given priority in cases where the indoor unit has an auto start ON / OFF jumper. Note also that regardless of whether switch SW2-R is on or off, the operating mode (NOTE), set temperature, fan direction and speed settings, and remote control prohibition status are stored.

SW2-R setting	What Happens
OFF (Factory setting)	Stops after recovering from a power outage
ON	Stops if the unit was stopped before the power outage and runs if it was running.

(NOTE) The following settings apply to the models below.

Mode before the power outage	Room air conditioner	Models with humid heating and dehumidifying functions.	Models with dehumidifying function.
COOLING	COOLING	DRY COOLING	HEATING
HEATING	HUMID HEATING	HEATING	

(4) Contact input function settings (SW3-1 to SW3-2)  
 When using contact input (S1), choose one of the following functions.

S1 operating mode	SW3-1 setting	SW3-2 setting	What Happens	Control mode
Instantaneous contact input (factory setting)	OFF	OFF	The operating status of the air conditioner is reversed by an instantaneous input of 100 msec. or more.	Last command priority
Constant contact input	OFF	ON	Contact - Open to close air condition runs. Close to open: air conditioner is stopped (NOTE 1).	ON / OFF control is rejected (operate / stop / timer prohibition) (NOTE 2).
Remote control all prohibition/permission input	ON	Invalid	Contact - Open to close: air condition stops. Close to open: no change in operating status.	All remote controller actions are prohibited when the contact is closed. (NOTE 3)

**NOTE1:** Since central equipment uses last command priority, the contact status and operating status of the air conditioner might not match sometimes.  
 Example: If the unit is run from the central controller while the air conditioner is stopped with an open contact, the contact will be open and the unit will be running.

**NOTE2:** Operating mode and fan direction and speed settings can be changed.

**NOTE3:** If the contact is closed while the ON timer is set, as the power ON timer function is still operating, the operation starts at the time specified by the timer. To prevent operation of the power ON timer, use of the (KRP413AB1S) remote control PC-board set is recommended. However, note that it cannot be used in tandem with the central controller.  
 If this product is connected to an air conditioner manufactured in or after 2011, when the contact is closed, the power ON timer may be cancelled depending on the combination with the model.

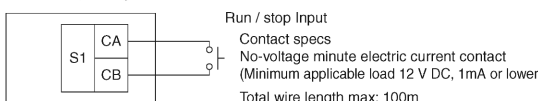

### 5. Control Codes

When using a central remote controller, the operating codes can be used to limit operation from wireless remote controllers. Three beeps for signal reception will be heard continuously when the wireless remote controller is operated while in central control.  
 ○ : permitted; × : prohibited

S1 operating mode	Control mode	Control code	Operations from the remote controller							
			"Run" control from the central controller		"Stop" control from the central controller					
Instantaneous contact mode	ON / OFF control is rejected	0, 1, 3, 10, 11	×	×	×	×	×	×	×	×
	Only OFF control is accepted	2, 12-19	×	×	×	×	×	×	×	×
	Central priority	4	○	○	○	○	×	×	×	×
	Last command priority	5	○	○	○	○	×	×	×	×
	Timer operation is accepted by remote controller	6, 7, 8, 9	○	○	○	○	×	×	×	×
	Constant contact mode	2, 10-19, 0, 1, 3, 5-7	×	×	×	×	×	×	×	×
All remote controller actions are prohibited	4, 8, 9	×	×	×	×	×	×	×	×	

○ Only during timer operation  
 The remote controller permission / prohibition settings using the Intelligent Touch Controller are as follows.  
 ○ : permitted; × : prohibited

S1 pin operating mode	Intelligent Touch Controller settings			Operations from the remote controller			
	Start / stop	Change operating mode	Change set temperature	Run / timer	Stop	Operating mode temperature	Fan direction and fan speed
Instantaneous contact mode	ON / OFF control is rejected	permitted	permitted/prohibited	×	×	○	×
Constant contact mode	permitted	permitted/prohibited	×	×	×	×	×
Instantaneous contact mode	Only OFF control is accepted	permitted	permitted/prohibited	×	×	×	×
Constant contact mode	permitted	permitted	×	×	×	×	×
Instantaneous contact mode	Last command priority	permitted	permitted/prohibited	×	×	×	×
Constant contact mode	permitted	permitted/prohibited	×	×	×	×	×
All remote controller actions are prohibited	Does not affect settings	×	×	×	×	×	×

### 6. Read Operating / Error Display Signal

The Operating / error signals can be read from the contact output (S5).  
 Output specs  
 M1: Turn MR 1 ON when the air conditioner is running.  
 M2: Turn MR 2 when a communication error has occurred between the KRP928BB2S and the air conditioner, or MR 1 is ON and the unit has stopped after an error.  
 MR 2 is not turned ON during a warning.

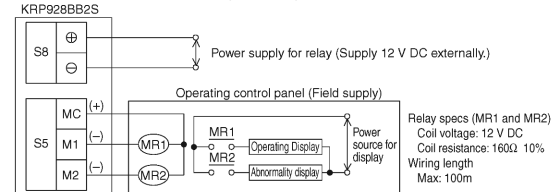

### 7. Combining Equipment

The central controller can be combined with the following devices.

	Central Remote Controller	ON / OFF controller	Schedule timer	D-BIPS	Contact input	Wired Remote Controller	Wireless Remote Controller
Central Remote Controller	○	○	○	○	○	○	○
ON / OFF controller	○	○	○	○	○	○	○
Schedule timer	○	○	×	×	○	○	○
D-BIPS	○	○	×	×	○	○	○
Contact input	○	○	○	○	×	○	○
Wired Remote Controller	○	○	○	○	○	×	×
Wireless Remote Controller	○	○	○	○	○	○	×

## Connection to Remote Control PC-board

### 1. Removal of upper HA casing

① Insert a flat-blade screwdriver into the groove between the upper and lower casings.

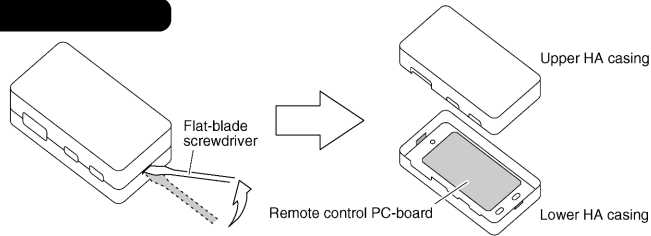

② Lift the handle of the screwdriver upward.

### 2. Securing of lower HA casing

Mount and secure the lower HA casing directly on the wall with the provided screws inserted into the screw holes (a round hole and two ellipse holes) of the casing.

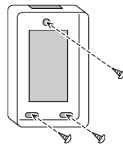

**NOTE** Mount the HA casing in a direction where the wiring through-holes will be hidden in order to prevent infants from putting their fingers into the HA casing and the LED light on the internal PC board from leaking outside.

### 3. Connection of wiring

Connect the wiring to the connector terminals.

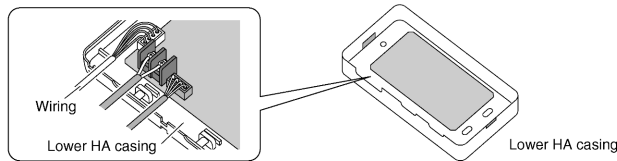

### 4. Fixation of wiring

① Insert the provided binding band under the pillar of the HA casing and secure the covers of the wiring with the binding band.

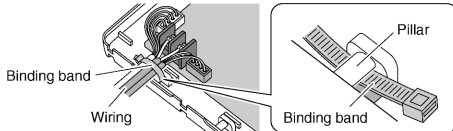

② Insert the second binding band into the groove on the side of the HA casing and fix the wiring securely so that the wiring will not be disconnected.

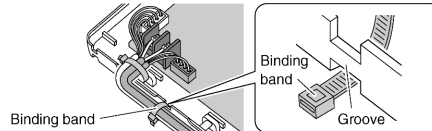

#### A large number of wires

Make a slit with an appropriate tool, such as a cutter knife, on the thin part of the upper HA casing along the frame. Then cut the part with an appropriate tool, such as a pair of nippers.

(NOTE) Cut off only the thin part required for wiring.

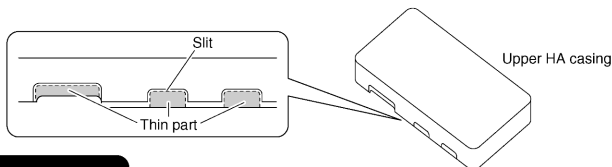

### 5. Finishing

Mount the upper HA casing to the original position.

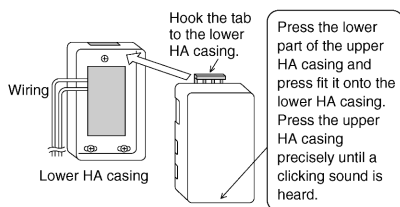

**Information**





**When the contact input device (such as card keys) and central controller are used in tandem:**

Even when the operating mode of the S1 pin is set to prohibit all remote controller actions, run/stop operation from the central controller is possible. The operation also starts when the power ON timer of the indoor unit is up while all remote controller actions are prohibited. (\*) In this case, stop the operation from the central controller. For the compatible models of the (KRC944 series) remote controller, the operation can be prohibited by using the remote controller in tandem with the central controller. \*If this product is connected to an air conditioner manufactured in or after 2011, when the contact is closed, the power ON timer may be cancelled depending on the combination with the model.

### 13.6 <KPW063A4> Air Direction Adjustment Grille

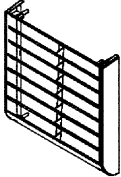
**Component parts** Be sure to check that the following parts are included before installation.

Component parts

Name	① Air direction adjustment grille	② Screw	③ Spacer	④ Installation Manual
Illustration				
Quantity	1 pcs.	4 pcs.	4 pcs.	1 sheet(this sheet)

**Selection of installation site**

Install only on an outdoor unit in a location that satisfies the following conditions:

- When installing the outdoor unit near the neighbouring house,
- Where you wish to change the exhaust airflow direction because the outdoor unit has been installed facing a road, so that passing people are not exposed to its exhaust air
- When changing the airflow direction to prevent exhaust blowing directly onto passersby or garden plants.

**Cautions for usage**

- Be sure to perform the following as installation precautions to ensure correct and safe use of the air direction adjustment grille.
  1. Install the product so that it is situated high enough to allow access to the outdoor unit for maintenance purposes.
  2. When installing the product in a location in which it may be exposed to strong winds, install a rollover prevention bracket (sold separately) at the same time.
  3. Tighten screws securely. Failure to do so may result in vibration.

#### ① Verifying the amount of space required for installation

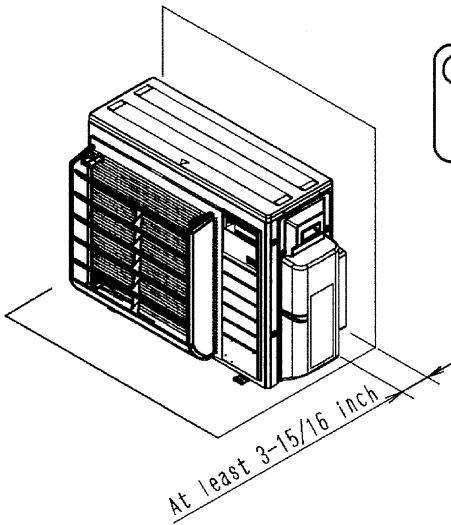

**⚠ Caution**

Leave at least 3-15/16 inch between the rear of the outdoor unit and any obstructions(walls, etc.).

**2 Installation of air direction adjustment grille**

**⚠ Caution**

Install the air direction adjustment grille on top of the outlet grille.  
 Be sure to install the outlet grille as installing only the air direction adjustment grille would allow a person to reach his or her hand into the outdoor unit far enough to come into contact with the rotating fan.

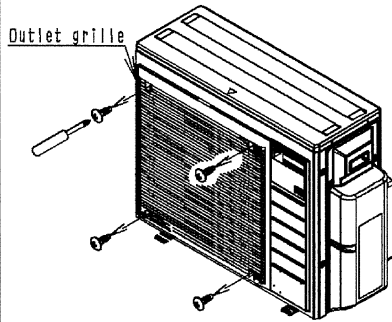

- (1) Remove the 4 outlet grille fixing screws.
- (2) Referring to the following illustration, attach the outlet grille and air direction adjustment grille, taking care to align them with the air outlet direction.
- Attach the air direction adjustment grille on top of the outlet grille using the same screws.

Upward facing

Downward facing

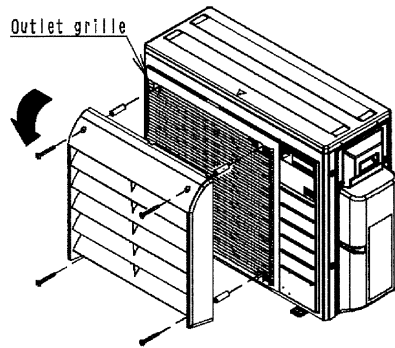
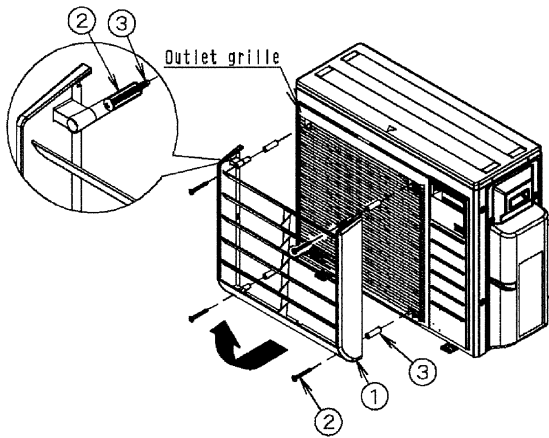

**Appearance of the air direction adjustment grille after installation (when installed with the louvers facing up)**

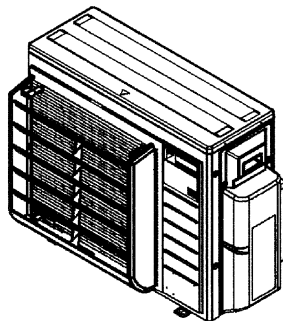



### 13.7 <KKG063A42> Back Protection Wire Net

**Component parts**

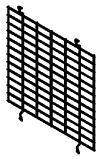
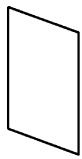
Name	① Protection net	② Installation manual
Shape		
Q'ty	1pc.	1sheet (this sheet)

**Caution**

Be sure to wear protection gloves when performing installation work as the fins on the heat exchanger may cause injury.

**Part names**

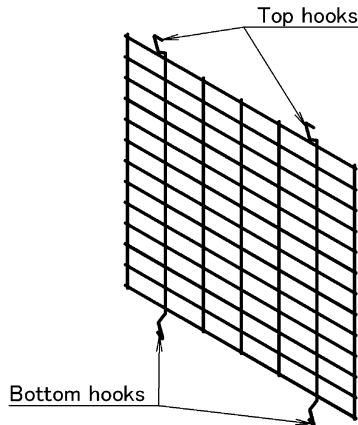

**2 Attach the protection net (①)**

Orient the protection net (①) so that top and bottom hooks are facing the heat exchanger and insert the two bottom hooks between the heat exchanger and the bottom frame.

Insert the two top hooks between the heat exchanger and the top panel while flexing the protection net (①).

※ Be careful not to damage the heat exchanger's cooling tubes.

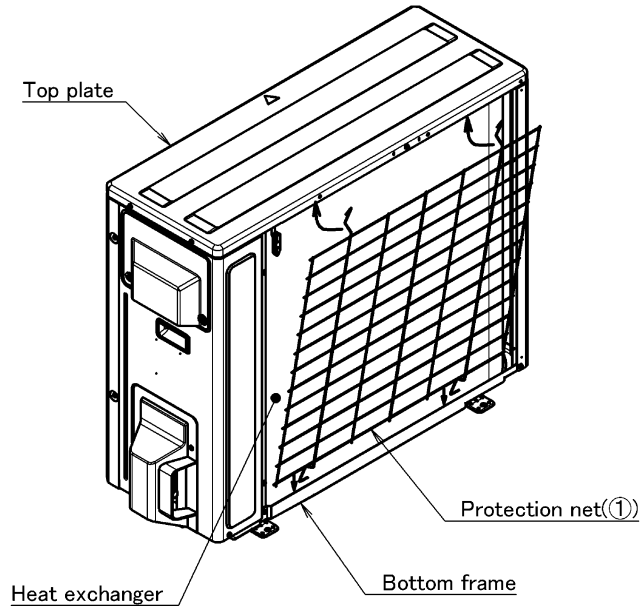

**1 Verify the location at which the protection net (①) is to be installed.**

Attach the protection net (①) so that the vertical grating is aligned with the edge of the installation leg on the right side of the outdoor unit.

Positioning line when installing the protection net (①)

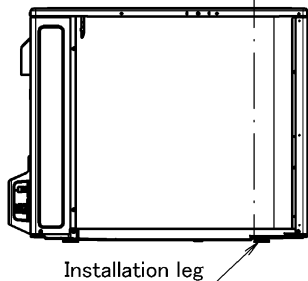

**3 Appearance of the protection net (①) following installation**

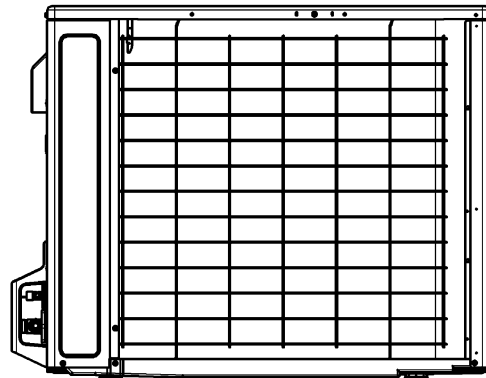

### 13.8 <FTDBHML, KEH063A4E> Drain Pan Heater

## Safety Considerations for Installation of Drain Pan Heater

Read these **Safety Considerations** carefully before installing the drain pan heater. After completing the installation, check if the unit operates properly during the start-up operation.

Meaning of **DANGER**, **WARNING** and **CAUTION** symbols.

<b>DANGER</b>	Indicates an imminently hazardous situation which, if not avoided, will result in death or serious injury.	<b>CAUTION</b>	Indicates a potentially hazardous situation which, if not avoided, may result in minor or moderate injury. It may also be used to alert against unsafe practices.
<b>WARNING</b>	Indicates a potentially hazardous situation which, if not avoided, could result in death or serious injury.		

- Inform users that they should store this installation manual for future reference.
- After completing the installation, make sure that the unit operates properly during the startup operation.
- All phases of the field-installation, including, but not limited to, electrical, piping, and safety, must be done in accordance with manufacturer's instructions and must comply with national, state, provincial, and local codes.
- This product is a heater designed to melt snow that is blown into the product from the outside to prevent the drain pan of the outdoor unit from freezing.
- Install the product with a snow-break hood on a high stand if this product is used in heavy snow areas.

**DANGER**

- Do not touch the heater unit without wearing gloves.**  
The temperature of the heater unit will become high when the heater is turned on. Touching the heater unit with bare hands will result in burns or injury.

**WARNING**

- Request the dealer or an authorized technician to install the product.**  
Improper installation of the product could result in water leakage, an electric shock, or fire.
- The product must be installed according to the instructions given in this manual.**  
The incomplete installation of the product could result in water leakage, an electric shock, or fire.
- Use the supplied or specified installation parts.**  
Use of other parts could result in the unit becoming loose and falling, water leakage, electric shock, or fire.
- Turn off the power supply at the time of installation.**  
Touching any electrical parts may with the power supply turned on could result in electric shock.
- Use specified wires. Connect and fix the wires so that the wires will not put improper force on the terminal junctions.**  
Wires connected or fixed improperly could result in terminal overheating, an electric shock, or fire.
- When wiring and connecting the indoor and outdoor units, carefully arrange the wiring so that they will not put improper force on the structures.**  
Install covers over the wires. Incomplete cover installation could result in terminal overheating, an electric shock, or fire.

**CAUTION**

- Wear protective gloves at the time of installation.**  
Touching the suction mouth or aluminum fin of the outdoor unit may result in injury.
- Do not install the product in places where there is danger of exposure to inflammable gas leakage.**  
If the gas leaks and builds up around the unit, it may catch fire.
- Do not grab the top plate of the outdoor unit carelessly when removing the top plate.**  
The sharp edge of the top plate may cause injury.
- Do not install the outdoor unit in places where small animals may nest in the outdoor unit.**  
If small animals intrude and touch the internal parts of the outdoor unit, the outdoor unit may malfunction, generate smoke, or ignite. Advise the user to keep the place clean.
- Do not touch the heater unit with bare hands.**  
The temperature of the heater unit will become high when the heater is turned on. Touching the heater unit with bare hands may result in burns or injury.

## Accessories

		KEH067A41E FTDBHMS	KEH063A4E FTDBHML		KEH067A41E FTDBHMS	KEH063A4E FTDBHML
Ⓐ Drain pan heater	1	1		Ⓔ Installation manual (multi-language)	1	1
Ⓑ M4 piercing screw	3	6		Ⓕ Electric wiring diagram label	1	1
Ⓒ Binding band	1	1		Ⓖ Information label	1	1
Ⓓ Sealing material	1	2		Appearance of the Ⓐ drain pan heater may differ from some models.		

## Tools Required for Installation

- Electric drill
- $\phi 1/8$  inch ( $\phi 3.2\text{mm}$ ) drill
- Phillips screwdriver
- Nippers

## Installation Procedure (1)

### ⚠ WARNING

- Be sure to check that the power supply of the product is turned off.

Some stages in the installation procedure differ by model of outdoor unit. Refer to the instructions for the relevant model.

**Type A models** : RX09/12, RXN09/12, RXL09/12

**Type B models** : RX15/18/24, RXN18/24, RXL15

**Type C models** : 2/3/4MXS, 2/3MXL, RX30/36

### 1. Remove each component of the outdoor unit.

- 1) Remove the top plate.
- 2) Affix the Ⓕ electric wiring diagram label where there is enough space available on the back of the top plate.
- 3) Remove the screws from the protective wire mesh if one is fitted. (2 screws) (For type B and C models only)
- 4) Remove the front plate.
- 5) Remove the anti-drip cover. (For type B and C models only)
- 6) Affix the Ⓖ information label near the manufacture's label.

- The appearance of the outdoor unit and the number of screws may differ from some models.

- Screw types for each component are indicated as below.

No icon: Hexagon tapping screw  
 $\triangle$  : Truss head tapping screw

#### For type A models

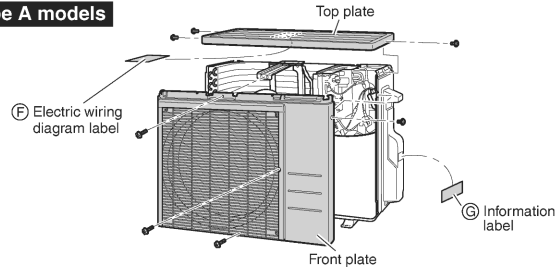

#### For type B and C models

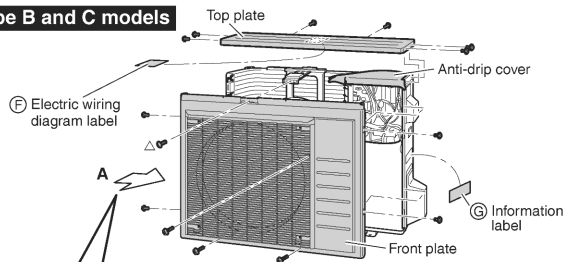

#### View A

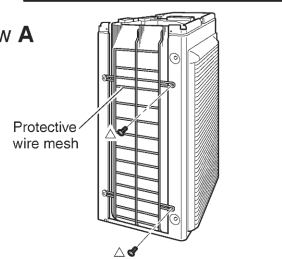

## Installation Procedure (2)

### 2. Remove the fan motor base.

- 1) Remove the fixing screws at the lower section of the fan motor base. (2 screws)
- 2) Remove the fan motor base together with the propeller fan and ensure that stress is not placed on the propeller fan when placing them aside.
  - Do not remove the fan motor harness.
  - Ensure that the fan motor harness does not come into contact with the edges of the heat exchanger or other components.

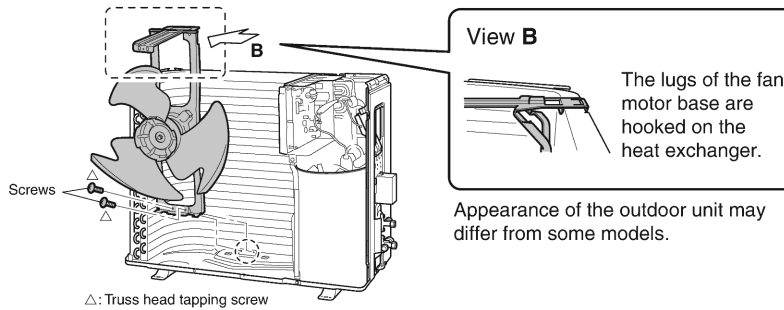

### 3. Install the drain pan heater.

#### ⚠ CAUTION

- When drilling a hole, be careful not to damage the soundproofing material and other components on the back side.

For details, refer to “Installation Procedure (3)” also.

- 1) Remove 1 screw from the bottom frame so that the plates of the Ⓐ drain pan heater can be inserted under the heat exchanger with ease.
- 2) Lift up the heat exchanger, and insert the plates of the Ⓐ drain pan heater under the heat exchanger.
  - The ground plate of the Ⓐ drain pan heater should be installed so that, in type A models, it firmly adheres to the bottom frame and, in type B and C models, it firmly adheres to the partition plate.
  - Install the Ⓐ drain pan heater in a position where it does not come into contact with the fan motor base.
- 3) If there are no holes, drill  $\phi 1/8$  inch ( $\phi 3.2$ mm) holes in the bottom frame and the partition plate to fix the Ⓐ drain pan heater.
  - Place the actual components to ensure positioning is correct before drilling holes.
  - The holes can be made with the included piercing-screw as well.
- 4) Fix the Ⓐ drain pan heater with the Ⓑ piercing screws.
- 5) Reattach the screw that was removed from the bottom frame.

## Installation Procedure (3)

### For type A models

Location and number of holes  
Bottom frame: 2

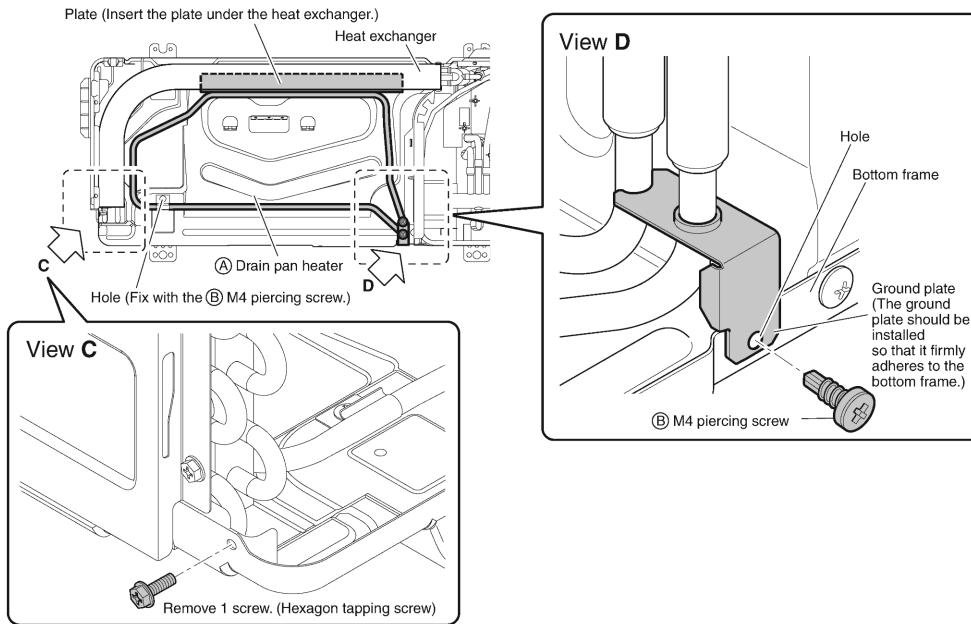

### For type B and C models

Location and number of holes  
Bottom frame: 1  
Partition plate: 2

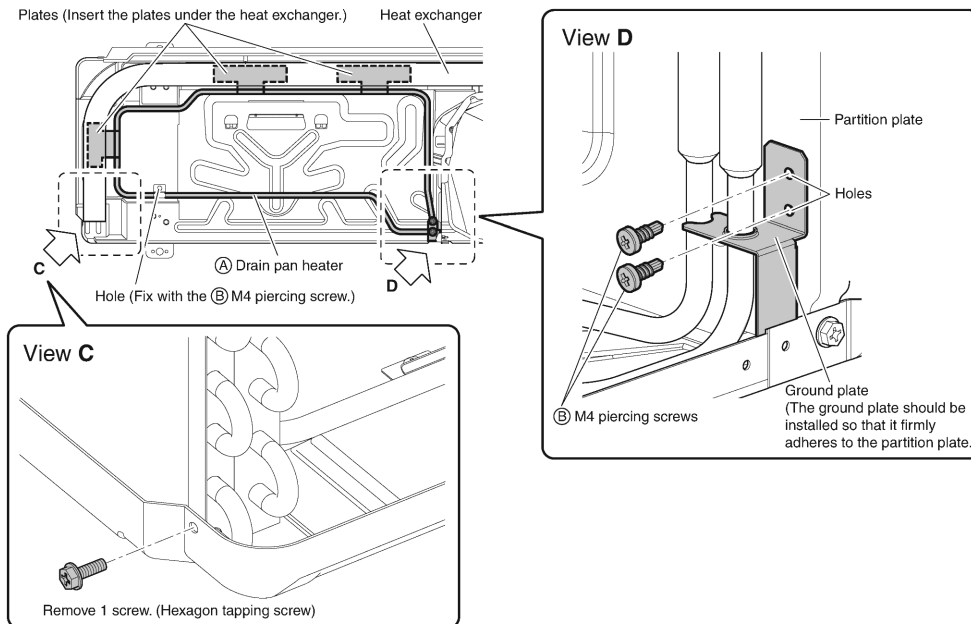

## Installation Procedure (4)

### 4. Route the harnesses.

**⚠ WARNING**

- When drilling a hole, be careful not to damage the soundproofing material and other components on the back side.

**For type A models**

- 1) If there is no hole, drill a  $\phi 1/8$  inch ( $\phi 3.2\text{mm}$ ) hole in the partition plate. (1 location)
- 2) Fix in place the binding band attached to the (A) drain pan heater harness by screwing the (B) M4 piercing screw into the hole. (1 location)
- 3) Install the fan motor base.
  - Be careful not to confuse screw types. Refer to “Installation Procedure (2)”.
- 4) Place the (A) drain pan heater harness on top of the fan motor harness, and fix it in place with the (D) sealing material.

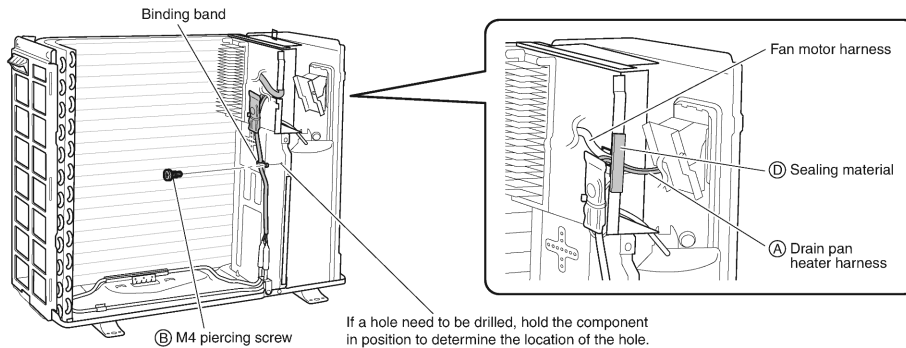

**For type B and C models**

- 1) If there are no holes, drill  $\phi 1/8$  inch ( $\phi 3.2\text{mm}$ ) holes in the partition plate. (3 locations)
- 2) Fix the (A) drain pan heater harness in place by screwing the (B) M4 piercing screws into the holes. (3 locations)
- 3) Install the fan motor base.
  - Be careful not to confuse screw types. Refer to “Installation Procedure (2)”.
- 4) Trim the electrical wiring box with nippers at the locations shown in the figures, then cover the trimmed edges with the (D) sealing material.
- 5) Insert the (A) drain pan heater harness into the space that was trimmed, and fix it in place using the (D) sealing material.

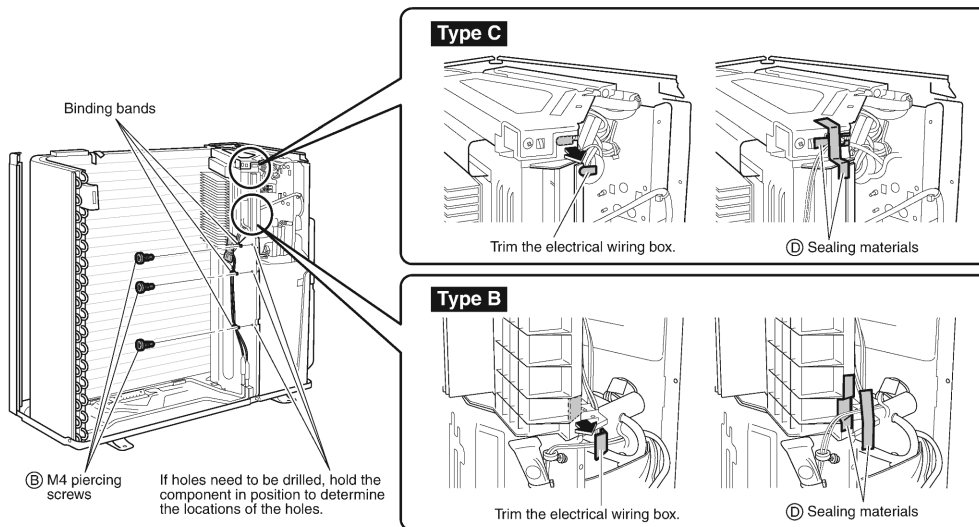

## Installation Procedure (5)

### 5. Connect the faston terminals of the drain pan heater to the terminal block of the outdoor unit.

- 1) Connect the thermostat-side terminal (black harness) to the leftmost terminal and the heater-side terminal (white harness) to the second leftmost terminal.
  - For type C models, connect to the last terminal block of the terminal blocks in use.
- 2) Bundle the (A) drain pan heater harness so that there is no slack, and secure it with the (C) binding band. (1 location)
  - Cut the tip of the (C) binding band.

#### For type A models

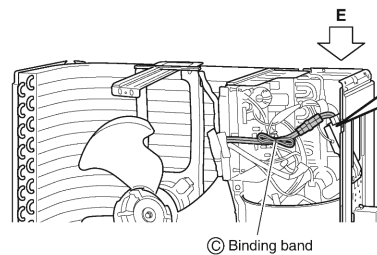

#### View E

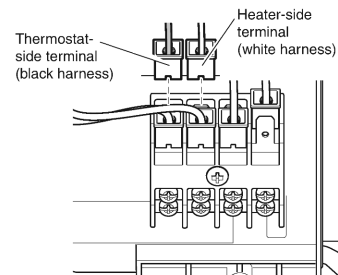

#### For type B models

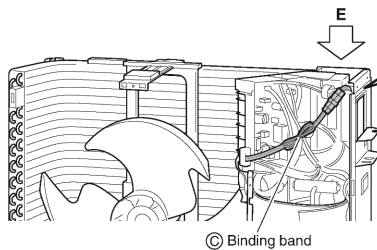

#### View E

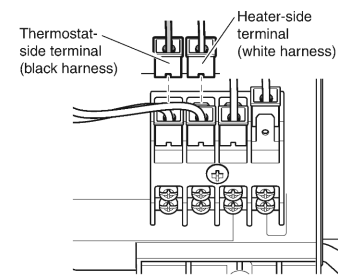

#### For type C models

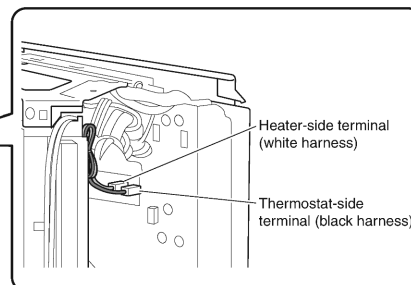
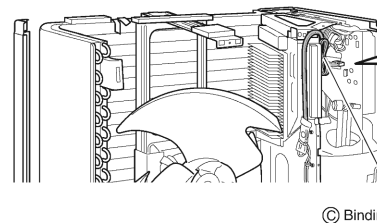

### 6. Install each component to the original position.

- Be careful not to confuse screw types. Refer to "Installation Procedure (1)".
- 1) Install the front plate.
  - 2) Install the anti-drip cover.  
(For type B and C models only)
  - 3) Install the top plate.

### 13.9 <KPS063A41> Snow Hood (Intake Side Plate)

**Parts** Before assembling the product, verify that all of the following parts have been included:

Name	Side plate (right)	Side plate (left)	Top plate	Front plate	Screws	Installation Manual
Illustration					 (quantity to use 14)	
Quantity	1	1	1	1	16	1 (this document)

**⚠ Caution** Read these safety considerations for installation carefully before installing the product.

● Be sure to observe the following installation precautions to ensure that the product can be used safely:

1. Install the product so that it is situated high enough to allow access to the outdoor unit for maintenance.
2. Installing the product in a location in which it may be exposed to strong winds, secure the outdoor unit with wire or other means.
3. Choose a location where the operating sound will not cause a nuisance to the neighbors of the user.
4. Tighten screws securely. Failure to do so may result in vibration.

**⚠ Caution . . . .**  
Indicates a potentially hazardous situation which, if not avoided, may result in minor or moderate injury. It may also be used to alert against unsafe practises.

#### 1 Installing the snow hood (intake side plate)

**1** Remove the protective wire mesh

1. Remove the 2 screws that hold the protective wire mesh.
2. Remove the 6 screws that hold the top plate and remove the top plate.
3. Remove the protective wire mesh, being careful of the part that is attached to the heat exchanger.
4. Attach the top plate removed in step 2 using the 6 screws removed in step 2.

**2** Attach the side plate (right) ①

1. Install the side plate (right) ① with the 2 screws that were used in the protective wire mesh that was removed in step 1.

- Use the second hook slot from the top and the 2 screw hole from the bottom.
- Installation is easiest if you start with the hook slot.



③ Attach the side plate (left) ②.

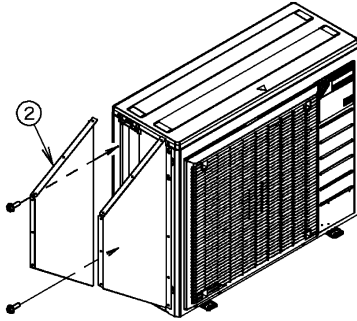

1. Install the side plate (left) ② with the 2 screws that were used in the protective wire mesh that was removed in step ①.

- Use the second hook slot from the top and the 2 screw hole from the bottom.
- Installation is easiest if you start with the hook slot.

④ Attach the front plate ④.

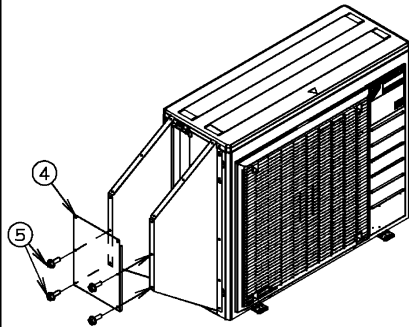

1. Temporarily secure the front plate ④ in place with the 4 screws ⑤.

⑤ Attach the top plate ③.

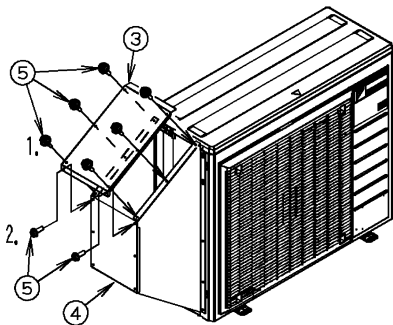

1. Attach the top plate ③ with the 6 screws ⑤.
2. Temporarily secure the top plate ③ and the front plate ④ to the side plate (right) ① and the side plate (left) ② with the 2 screws ⑤.
3. Tighten the 12 screws ⑤ that you used to temporarily secure parts in steps ④ and ⑤.

## ② Appearance of the snow hood (intake side plate) after installation

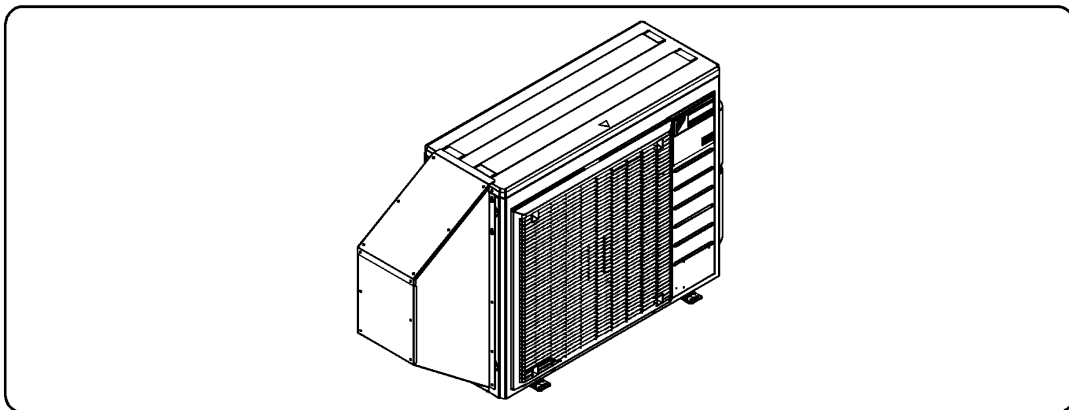

### 13.10 <KPS063A44> Snow Hood (Intake Rear Plate)

**Parts** Before assembling the product, verify that all of the following parts have been included:

Name	Side plate	Side plate	Top plate	Front plate	Screws	Piercing screw	Installation Manual
Illustration	① (Right)	② (Left)	③	④	⑤	⑥	⑦
Quantity	1	1	1	1	14	3	1 (this document)

**⚠ Caution** Read these safety considerations for installation carefully before installing the product.

● Be sure to observe the following installation precautions to ensure that the product can be used safely:

1. Install the product so that it is situated high enough to allow access to the outdoor unit for maintenance.
2. Installing the product in a location in which it may be exposed to strong winds, secure the outdoor unit with wire or other means.
3. Choose a location where the operating sound will not cause a nuisance to the neighbors of the user.
4. Tighten screws securely. Failure to do so may result in vibration.

**⚠ Caution . . . .**  
Indicates a potentially hazardous situation which, if not avoided, may result in minor or moderate injury. It may also be used to alert against unsafe practises.

#### ① Installing the snow hood (intake rear plate)

**① Attach the side plate (right) ①.**

1. Use the 3 piercing screws ⑥ included in the kit to install the side plate (right) ①.

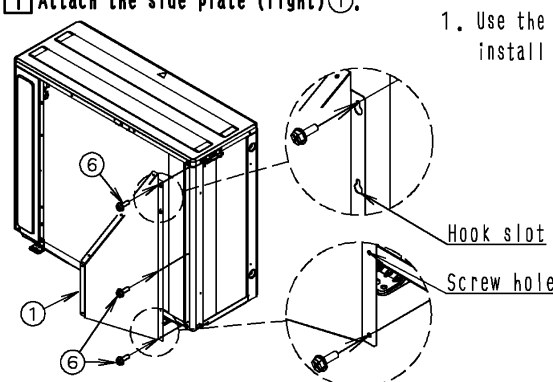

- For the hook slot, use the first hook slot from the top.
- For the screw hole, use the first screw hole from the bottom.
- Installation is easiest if you start with the hook slot.
- Align the screw installation position with the dowel hole.

**② Attach the side plate (left) ②**

1. Remove the 2 screws (☆) that hold the heat exchanger.  
2. Install the side plate (left) ② using the 2 screws removed in step 1.

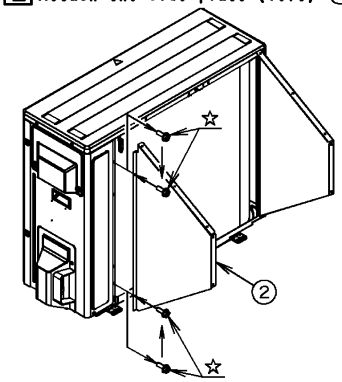

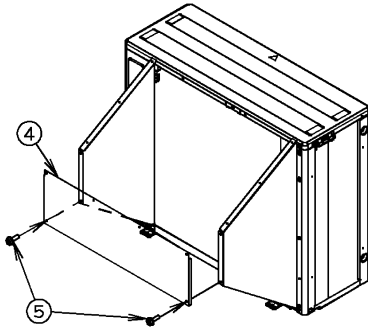
**③ Attach the front plate ④**

1. Temporarily secure the front plate ④ in place with the 2 screws ⑤ included in the kit.

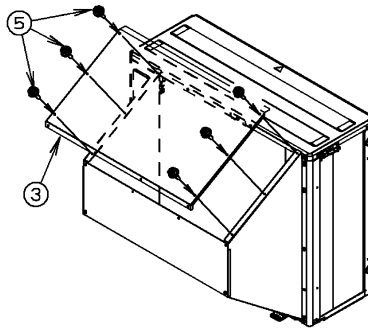
**④ Attach the top plate ③**

1. Temporarily secure the top plate ③ in place with the 6 screws ⑤ included in the kit.

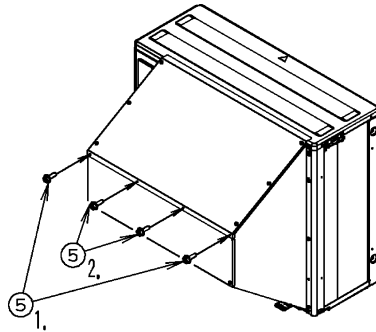



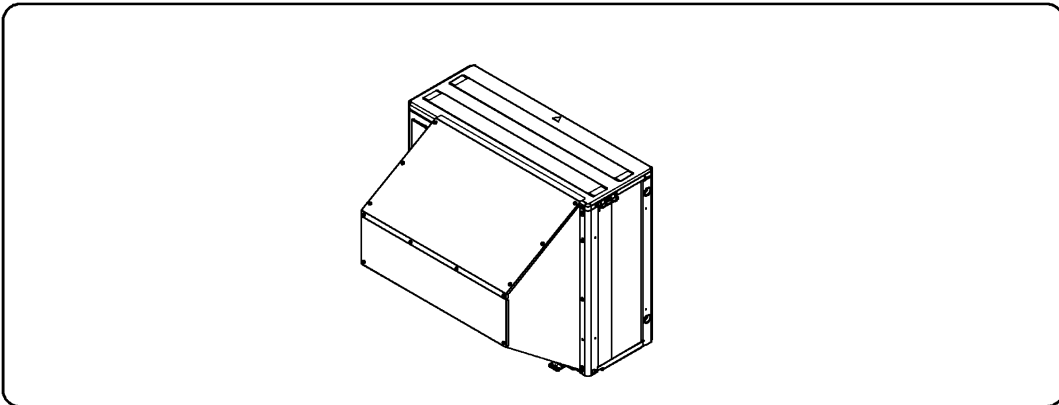

**⑤ Attach the top plate ③**

1. Temporarily secure the top plate ③ and front plate ④ to the side plate (right) ① and side plate (left) ② with the 2 screws ⑤ included in the kit.
2. Temporarily secure the top plate ③ to the front plate ④ with the 2 screws ⑤ included in the kit.
3. Tighten the 12 screws that you used to temporarily secure parts in steps 3), 4), and 5).

**② Appearance of the snow hood (intake rear plate) after installation**

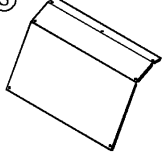
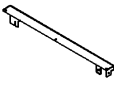
### 13.11 <KPS063A47> Snow Hood (Outlet)

**Parts** Before assembling the product, verify that all of the following parts have been included:

Name	Side plate	Side plate	Top plate	Installation plate	Screws	Piercing screw	Installation Manual
Illustration	① (Right) 	② (Left) 	③ 	④ 	⑤ 	⑥ 	⑦ 
Quantity	1	1	1	1	8	3	1 (this document)

**⚠ Caution** Read these safety considerations for installation carefully before installing the product.

● Be sure to observe the following installation precautions to ensure that the product can be used safely:

1. Install the product so that it is situated high enough to allow access to the outdoor unit for maintenance.
2. Installing the product in a location in which it may be exposed to strong winds, secure the outdoor unit with wire or other means.
3. Choose a location where the operating sound will not cause a nuisance to the neighbors of the user.
4. Tighten screws securely. Failure to do so may result in vibration.

**⚠ Caution . . . . .**  
Indicates a potentially hazardous situation which, if not avoided, may result in minor or moderate injury. It may also be used to alert against unsafe practises.

#### 1 Installing the snow hood (outlet)

**1 Remove the discharge grille.**

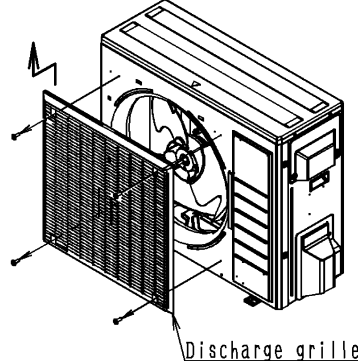

Discharge grille

1. Remove the 4 screws that hold the discharge grille. (The discharge grille is held with the 4 screws and 2 hooks.)

**2 Attach the side plate (left) ② and installation plate ④.**

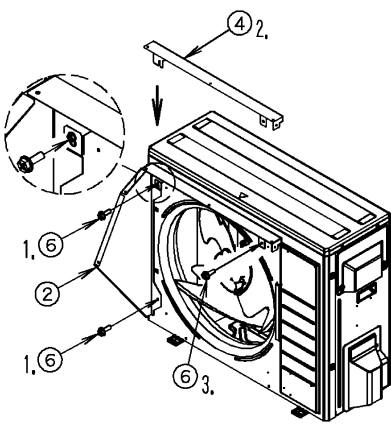

1. Temporarily secure the side plate (left) ② in place with the 2 piercing screw ⑥ included in the kit.
  - Installation is easiest if you start with the hook slot.
  - Align the screw installation position with the dowel hole.
2. Jointly tighten the installation plate ④ with the 1 piercing screw ⑥ temporarily secured in step 1.
3. Install the right side of the installation plate ④ with the 1 piercing screw ⑥.

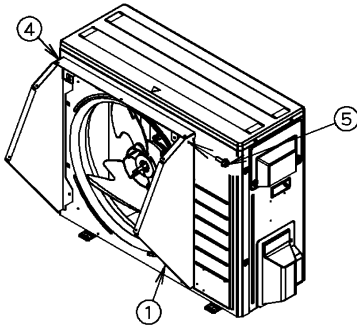
**3 Attach the installation plate ④.**

1. Install the side plate (right) ① and installation plate ④ with the 1 screws ⑤ included in the kit,

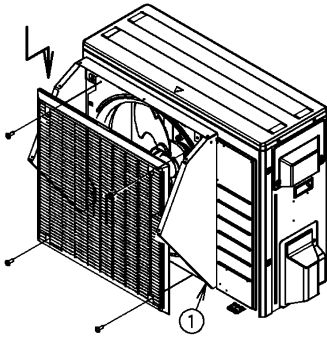
**4 Attach the discharge grille.**

1. When installing the discharge grille removed in [1], jointly tighten the side plate (right) ① with the 2 screws securing the discharge grille, (Secure the discharge grille with the 4 screws and 2 hooks.)

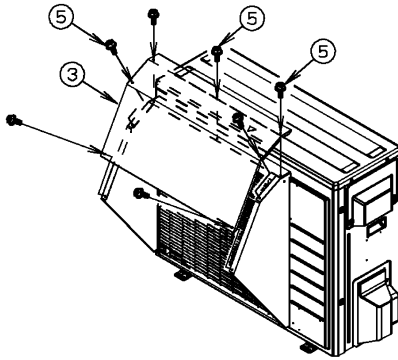
**5 Attach the top plate ③.**

1. Install the top plate ③ with the 7 screws ⑤ included in the kit,

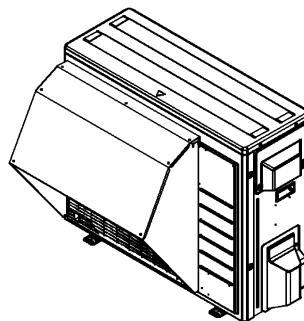
**2 Appearance of the snow hood (outlet) after installation**







**Warning**



- Ask a qualified installer or contractor to install this product. Do not try to install the product yourself. Improper installation can result in water or refrigerant leakage, electrical shock, fire or explosion.
- Use only those parts and accessories supplied or specified by Daikin. Ask a qualified installer or contractor to install those parts and accessories. Use of unauthorized parts and accessories or improper installation of parts and accessories can result in water or refrigerant leakage, electrical shock, fire or explosion.
- Read the user's manual carefully before using this product. The user's manual provides important safety instructions and warnings. Be sure to follow these instructions and warnings.

If you have any enquiries, please contact your local importer, distributor and/or retailer.

**Cautions on product corrosion**

1. Air conditioners should not be installed in areas where corrosive gases, such as acid gas or alkaline gas, are produced.
2. If the outdoor unit is to be installed close to the sea shore, direct exposure to the sea breeze should be avoided. If you need to install the outdoor unit close to the sea shore, contact your local distributor.