

AIR CONDITIONER

**Wall mounted type**

## DESIGN & TECHNICAL MANUAL

---

---

INDOOR



ASU9RLS3Y  
ASU12RLS3Y  
ASU15RLS3Y

---

OUTDOOR



AOU9RLS3  
AOU12RLS3  
AOU15RLS3

---

**FUJITSU GENERAL LIMITED**

**Notices:**

- Product specifications and design are subject to change without notice for future improvement.
- For further details, please check with our authorized dealer.

**Trademarks**

The following term and logo are trademarks of Fujitsu General Limited in the United States, other countries or both:

FGLair™



Android™ and Google Play™ are trademarks of Google Inc.

App Store® is a service mark of Apple Inc., registered in the U.S. and other countries.

IOS® is a trademark or registered trademark of Cisco in the U.S. and other countries and is used under license.

# CONTENTS

---

<b>Part 1. INDOOR UNIT</b> .....	<b>1</b>
<b>1. Specifications</b> .....	<b>2</b>
<b>2. Wireless LAN control</b> .....	<b>3</b>
2-1. System requirement.....	3
2-2. Wireless LAN function list .....	4
<b>3. Dimensions</b> .....	<b>5</b>
3-1. Models: ASU9RLS3Y, ASU12RLS3Y, and ASU15RLS3Y .....	5
<b>4. Wiring diagrams</b> .....	<b>7</b>
4-1. Models: ASU9RLS3Y, ASU12RLS3Y, and ASU15RLS3Y .....	7
<b>5. Capacity table</b> .....	<b>8</b>
5-1. Cooling capacity.....	8
5-2. Heating capacity .....	11
<b>6. Fan performance</b> .....	<b>13</b>
6-1. Air velocity distributions.....	13
6-2. Airflow .....	15
<b>7. Operation noise (sound pressure)</b> .....	<b>17</b>
7-1. Noise level curve.....	17
7-2. Sound level check point .....	18
<b>8. Safety devices</b> .....	<b>19</b>
<b>9. External input and output</b> .....	<b>20</b>
9-1. External input.....	20
9-2. External output.....	23
<b>10. Remote controller</b> .....	<b>25</b>
10-1. Wireless remote controller .....	25
<b>11. Function settings</b> .....	<b>27</b>
11-1. Function settings by using remote controller .....	27
11-2. Custom code setting for wireless remote controller.....	33
11-3. Switching the temperature unit of remote controller .....	34
<b>12. Accessories</b> .....	<b>35</b>
<b>13. Optional parts</b> .....	<b>36</b>
13-1. Controllers .....	36
13-2. Others .....	36

## CONTENTS (continued)

---

<b>Part 2. OUTDOOR UNIT</b> .....	<b>37</b>
<b>1. Specifications</b> .....	<b>38</b>
<b>2. Dimensions</b> .....	<b>39</b>
2-1. Models: AOU9RLS3, AOU12RLS3, and AOU15RLS3 .....	39
<b>3. Installation space</b> .....	<b>40</b>
3-1. Models: AOU9RLS3, AOU12RLS3, and AOU15RLS3 .....	40
<b>4. Refrigerant circuit</b> .....	<b>43</b>
4-1. Models: AOU9RLS3 and AOU12RLS3 .....	43
4-2. Model: AOU15RLS3 .....	44
<b>5. Wiring diagrams</b> .....	<b>45</b>
5-1. Models: AOU9RLS3 and AOU12RLS3 .....	45
5-2. Model: AOU15RLS3 .....	46
<b>6. Capacity compensation rate for pipe length and height difference</b> .....	<b>47</b>
6-1. Models: AOU9RLS3 and AOU12RLS3 .....	47
6-2. Model: AOU15RLS3 .....	48
<b>7. Additional charge calculation</b> .....	<b>49</b>
7-1. Models: AOU9RLS3 and AOU12RLS3 .....	49
7-2. Model: AOU15RLS3 .....	49
<b>8. Airflow</b> .....	<b>50</b>
8-1. Models: AOU9RLS3 and AOU12RLS3 .....	50
8-2. Model: AOU15RLS3 .....	50
<b>9. Operation noise (sound pressure)</b> .....	<b>51</b>
9-1. Noise level curve .....	51
9-2. Sound level check point .....	52
<b>10. Electrical characteristics</b> .....	<b>53</b>
<b>11. Safety devices</b> .....	<b>54</b>
<b>12. Accessories</b> .....	<b>55</b>

# **Part 1. INDOOR UNIT**

---

**WALL MOUNTED TYPE:**

**ASU9RLS3Y**

**ASU12RLS3Y**

**ASU15RLS3Y**

# 1. Specifications

Type			Wall mounted			
			Inverter heat pump			
Model name			ASU9RLS3Y	ASU12RLS3Y	ASU15RLS3Y	
Power supply			208/230 V ~ 60 Hz			
Power supply intake			Outdoor unit			
Available voltage range			188—253 V			
Capacity	Cooling	Rated	kW	2.64	3.52	4.25
			Btu/h	9,000	12,000	14,500
		Min.—Max.	kW	0.90—3.60	0.90—4.00	0.90—5.40
	Heating	Rated	Btu/h	3,100—12,000	3,100—13,600	3,100—18,400
			kW	3.52	4.69	5.28
		Min.—Max.	kW	0.90—6.45	0.90—6.48	0.90—7.00
Input power	Cooling	Rated	kW	0.50	0.79	1.04
			Min.—Max.	kW	0.20—0.85	0.20—0.99
		Heating	Rated	0.66	1.01	1.15
	Heating	Rated	kW	0.20—1.93	0.20—1.94	0.17—2.19
			Min.—Max.	kW	0.20—1.93	0.20—1.94
		Heating	Min.—Max.	kW	0.20—1.93	0.20—1.94
Current	Cooling	Rated	A	2.5	3.8	4.8
	Heating	Rated	A	3.3	4.7	5.2
EER	Cooling	Rated	kW/kW	5.28	4.46	4.09
			Btu/hW	18.0	15.2	13.9
COP	Heating	Rated	kW/kW	5.33	4.64	4.59
			Btu/hW	18.2	15.8	15.7
SEER	Cooling	Rated	Btu/hW	33.0	29.3	25.3
HSPF	Heating	Rated	Btu/hW	14.2	14.0	13.4
Power factor	Cooling	Rated	%	87	90	94
	Heating	Rated	%	87	93	96
Moisture removal			pints/h (L/h)	2.6 (1.2)	2.7 (1.3)	4.0 (1.9)
Maximum operating current *1	Cooling	Rated	A	9.4	9.4	9.9
	Heating	Rated	A	10.9	10.9	13.9
Fan	Airflow rate	Cooling	HIGH	489 (830)		547 (930)
			MED	400 (680)		459 (780)
			LOW	341 (580)		371 (630)
			QUIET	224 (380)		259 (440)
		Heating	HIGH	489 (830)		547 (930)
			MED	400 (680)		459 (780)
			LOW	341 (580)		371 (630)
			QUIET	224 (380)		294 (500)
	Type × Q'ty		Cross flow fan × 1			
	Motor output		W			
		61				
Sound pressure level *2	Cooling	HIGH	42		45	
		MED	37		40	
		LOW	32		34	
		QUIET	23		26	
	Heating	HIGH	41		45	
		MED	35		39	
		LOW	31		33	
		QUIET	23		27	
Heat exchanger type	Dimensions (H × W × D)		in (mm)	Main: 15-1/8 × 28-3/8 × 1-3/16 (384 × 720 × 30) Sub 1: 3-5/16 × 28-3/8 × 1/2 (84 × 720 × 13.3) Sub 2: 4-15/16 × 28-3/8 × 1/2 (126 × 720 × 13.3)		
	Fin pitch		FPI	Main: 21, Sub 1 and Sub 2: 18		
	Rows × Stages			Main: 3 × 24, Sub 1: 1 × 4, Sub 2: 1 × 6		
	Pipe type			Copper tube		
	Fin type			Aluminum		
Enclosure	Material		Polystyrene			
	Color		White Approximate color of Munsell 5PB 9.25/0.5			
Dimensions (H × W × D)	Net	in	11-5/8 × 37 × 10-5/8			
		mm	295 × 940 × 270			
	Gross	in	14-3/8 × 40-15/16 × 14			
		mm	365 × 1,040 × 355			
Weight	Net	lb (kg)	31 (14)			
	Gross	lb (kg)	37 (17)			
Connection pipe	Size	Liquid	Ø 1/4 (Ø 6.35)			
		Gas	Ø 3/8 (Ø 9.52)			
	Method		Flare			
Drain hose	Material		PP+LLDPF			
	Size	in (mm)	Ø 9/16 (Ø 13.8) (I.D.) Ø 5/8 to Ø 11/16 (Ø 15.8 to Ø 16.7) (O.D.)			
Operation range	Cooling	°F (°C)	64 to 90 (18 to 32)			
	Heating	%RH	80 or less			
Remote control	Remote controller		Wireless (Wired [option])			
	Mobile application *3		FGL new mobile app			

## NOTES:

- Specifications are based on the following conditions:
  - Cooling: Indoor temperature of 80 °FDB (26.67 °CDB) /67 °FWB (19.44 °CWB), and outdoor temperature of 95 °FDB (35 °CDB) / 75 °FWB (23.9 °CWB).
  - Heating: Indoor temperature of 70 °FDB (21.11 °CDB) /59 °FWB (15 °CWB), and outdoor temperature of 47 °FDB (8.33 °CDB) /43 °FWB (6.11 °CWB).
  - Pipe length: 24 ft 6 in (7.5 m), Height difference: 0 ft (0 m). (Between outdoor unit and indoor unit.)
- Protective function might work when using it outside the operation range.
- \*1: Maximum operating current is the total current of the indoor unit and the outdoor unit.
- \*2: Sound pressure level:
  - Measured values in manufacturer's anechoic chamber.
  - Because of the surrounding sound environment, the sound levels measured in actual installation conditions might be higher than the specified values here.
- \*3: Available on Google Play store or on App Store. For details, refer to the setting manual.

## 2. Wireless LAN control

By installing mobile app on a smart device, several functions can be controlled from outside the house.

### 2-1. System requirement

Before using this function, prepare the following items:

- **Wireless router:**

Wireless LAN standard	IEEE802.11b/g/n
Frequency bands*	<ul style="list-style-type: none"> <li>• U.S.A., Canada: 2.4 GHz (1ch—11ch)</li> <li>• Other countries: 2.4 GHz (1ch—13ch)</li> </ul>
Network security standard	<ul style="list-style-type: none"> <li>• Open</li> <li>• WEP</li> <li>• WPA (PSK)</li> <li>• WPA2 Personal (PSK)</li> <li>• WPS for same-LAN registration</li> </ul>

\*: Usable only in the country or region where you purchased the product.

To check whether your wireless router complies with the network security standards listed above, refer to the operation manual.

- **Smartphone or Tablet PC:**

App-compliant operating system	iOS®	Check the latest version of supported OS at Google Play™ store or App Store®.
	Android™	

- ***FGLair*™ (mobile application):**

Mobile app is available on Google Play store or on App Store.

After installation of mobile app, user registration is required. For user registration and setup information, refer to Setting Manual attached with the product.

For the latest version of the Wireless LAN (WLAN) control manuals, refer to the following web site.

<https://www.fujitsu-general.com/global/support/>

## 2-2. Wireless LAN function list

**NOTE:** To use Wireless LAN control, user registration in advance and access to the wireless home network are required.

Item		Mobile app	Attached wireless remote controller	
Air conditioning control function	Operation on/off	○	○	
	Operation mode setting	○	○	
	Set temperature setting	○	○	
	Fan speed setting	○	○	
	Airflow direction setting	Louver position adjustment (vertical/horizontal)	○	○
		Swing (vertical/horizontal)	○	○
	Timer setting	Off timer	—	○
		On timer	—	○
		Sleep timer	—	○
		On/off program timer	—	○
	Weekly timer	○	○	
Additional function	POWERFUL operation setting	○*	○*	
	ECONOMY operation setting	○	○	
	MIN. HEAT operation setting	○*	○*	
	Human sensor setting	○*	○*	
	Outdoor unit low noise operation setting	○*	○*	
App function	Air conditioner error e-mail notification	○	—	

\*: Not operable when wired remote controller is connected.





## Installation space requirement

Provide sufficient installation space for product safety.

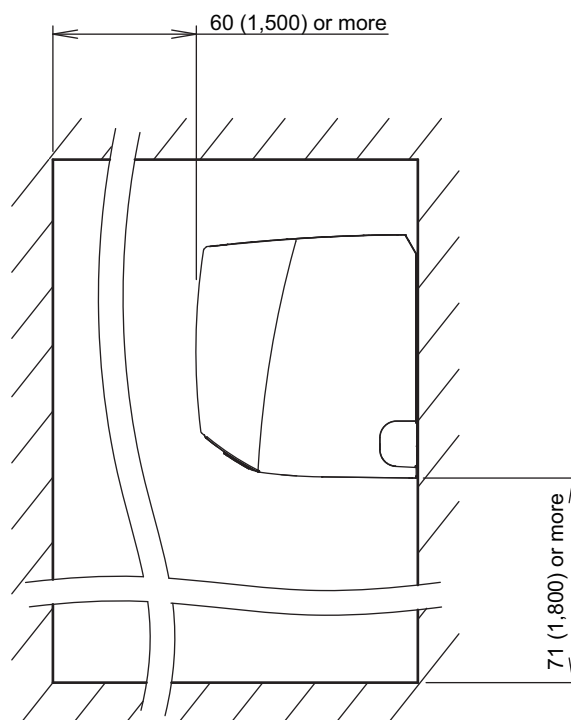
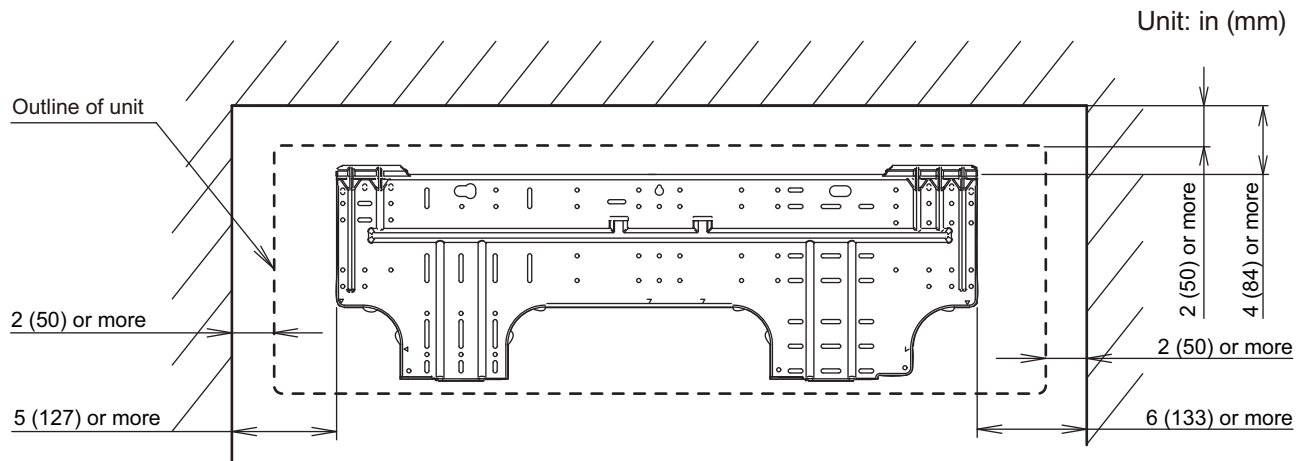

# 4. Wiring diagrams

## 4-1. Models: ASU9RLS3Y, ASU12RLS3Y, and ASU15RLS3Y

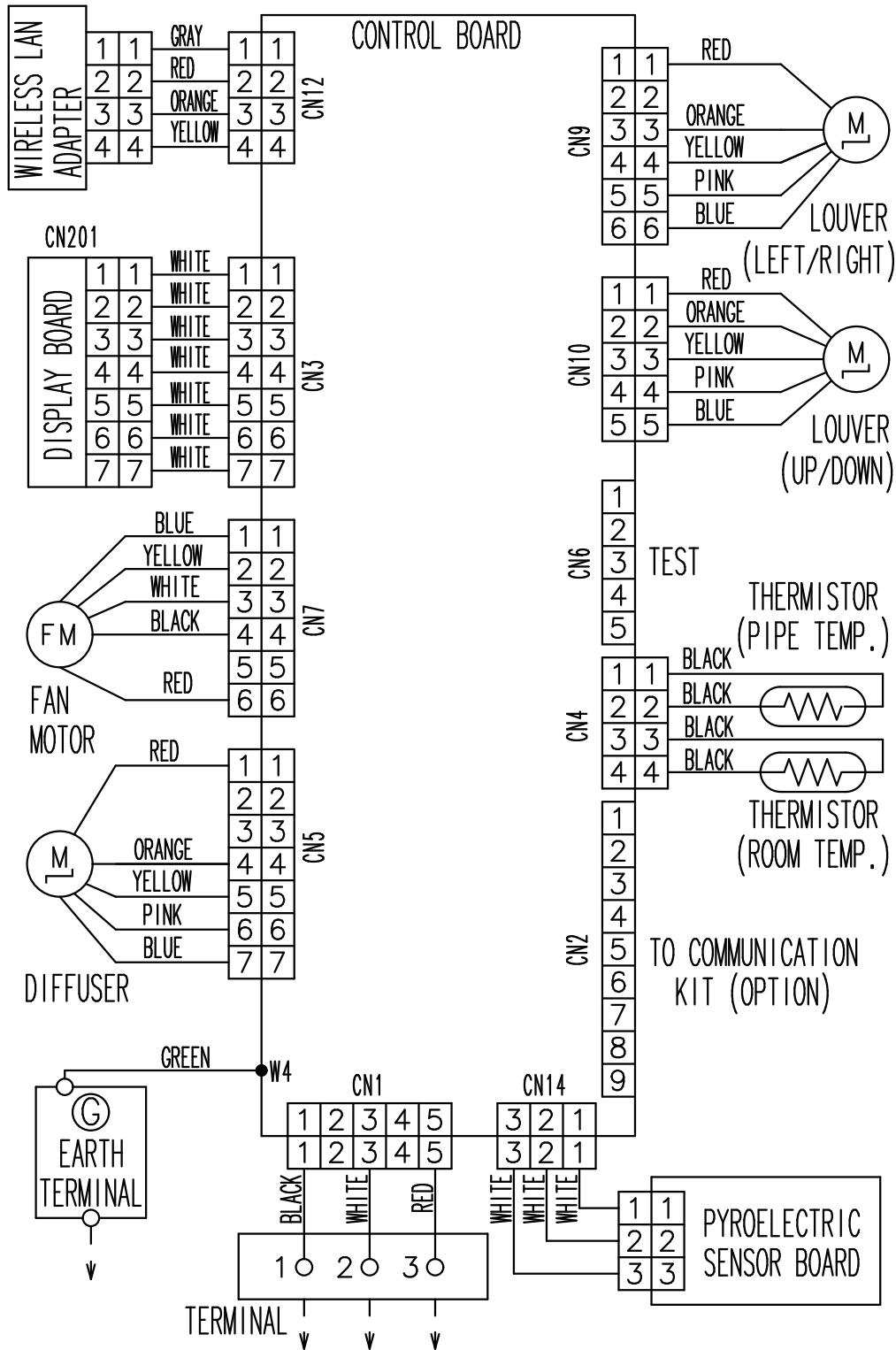

## 5. Capacity table

Capacity tables show each of following values calculated based on the outdoor temperature and the indoor temperature, under given Airflow Rate (AFR):

**For cooling capacity:** Total Capacity (TC), Sensible Heat Capacity (SHC), and Input Power (IP)

**For heating capacity:** Total Capacity (TC) and Input Power (IP)

### 5-1. Cooling capacity

#### ■ Model: ASU9RLS3Y

AFR	CFM	489
-----	-----	-----

		Indoor temperature																	
		64			70			75			80			85			90		
		54			60			63			67			71			73		
Outdoor temperature	°FDB	TC	SHC	IP	TC	SHC	IP	TC	SHC	IP	TC	SHC	IP	TC	SHC	IP	TC	SHC	IP
	°FWB	kWh			kW			kWh			kW			kWh			kW		
	15	8.33	8.06	0.19	9.29	8.11	0.19	10.25	8.87	0.20	10.57	9.53	0.20	11.17	9.50	0.20	11.81	10.07	0.21
	23	8.16	7.88	0.22	9.09	7.91	0.22	10.03	8.65	0.23	10.35	9.31	0.22	10.94	9.28	0.22	11.56	9.91	0.23
	32	7.99	7.69	0.22	8.90	7.75	0.23	9.81	8.45	0.24	10.13	9.16	0.23	10.70	9.09	0.23	11.32	9.68	0.24
	41	7.81	7.58	0.24	8.71	7.61	0.24	9.60	8.28	0.25	9.90	8.97	0.24	10.47	8.90	0.24	11.07	9.50	0.25
	50	7.64	7.36	0.22	8.51	7.41	0.22	9.38	8.07	0.24	9.68	8.76	0.23	10.24	8.70	0.23	10.83	9.26	0.24
	59	7.47	7.24	0.27	8.32	7.27	0.27	9.16	7.91	0.28	9.46	8.57	0.28	10.01	8.51	0.28	10.58	9.08	0.28
	67	8.42	8.15	0.34	9.38	8.18	0.35	10.33	8.94	0.36	10.67	9.63	0.36	11.28	9.59	0.36	11.93	10.18	0.37
	77	8.01	7.74	0.39	8.93	7.77	0.39	9.85	8.49	0.40	10.16	9.15	0.40	10.74	9.11	0.41	11.35	9.73	0.41
	87	7.57	7.29	0.44	8.45	7.36	0.44	9.31	8.01	0.45	9.58	8.67	0.45	10.16	8.63	0.46	10.74	9.18	0.46
	95	7.09	6.88	0.48	7.91	6.91	0.49	8.73	7.53	0.50	9.00	8.15	0.50	9.55	8.12	0.51	10.06	8.63	0.51
104	6.00	5.67	0.45	6.68	6.16	0.46	7.36	6.71	0.46	7.60	7.26	0.46	8.05	7.22	0.47	8.52	7.70	0.47	
115	5.52	5.33	0.45	6.17	5.71	0.46	6.78	6.22	0.46	6.99	6.74	0.46	7.43	6.71	0.47	7.84	7.15	0.47	

AFR	m <sup>3</sup> /h	830
-----	-------------------	-----

		Indoor temperature																	
		17.8			21.1			23.9			26.7			29.4			32.2		
		12.2			15.6			17.2			19.4			21.7			22.8		
Outdoor temperature	°CDB	TC	SHC	IP	TC	SHC	IP	TC	SHC	IP	TC	SHC	IP	TC	SHC	IP	TC	SHC	IP
	°CWB	kW			kW			kW			kW			kW			kW		
	-10.0	2.44	2.36	0.19	2.72	2.38	0.19	3.00	2.60	0.20	3.10	2.79	0.20	3.27	2.78	0.20	3.46	2.95	0.21
	-5.0	2.39	2.31	0.22	2.67	2.32	0.22	2.94	2.53	0.23	3.03	2.73	0.22	3.21	2.72	0.22	3.39	2.90	0.23
	0.0	2.34	2.25	0.22	2.61	2.27	0.23	2.88	2.48	0.24	2.97	2.68	0.23	3.14	2.67	0.23	3.32	2.84	0.24
	5.0	2.29	2.22	0.24	2.55	2.23	0.24	2.81	2.43	0.25	2.90	2.63	0.24	3.07	2.61	0.24	3.25	2.79	0.25
	10.0	2.24	2.16	0.22	2.49	2.17	0.22	2.75	2.37	0.24	2.84	2.57	0.23	3.00	2.55	0.23	3.17	2.71	0.24
	15.0	2.19	2.12	0.27	2.44	2.13	0.27	2.69	2.32	0.28	2.77	2.51	0.28	2.93	2.49	0.28	3.10	2.66	0.28
	19.4	2.47	2.39	0.34	2.75	2.40	0.35	3.03	2.62	0.36	3.13	2.82	0.36	3.31	2.81	0.36	3.50	2.98	0.37
	25.0	2.35	2.27	0.39	2.62	2.28	0.39	2.89	2.49	0.40	2.98	2.68	0.40	3.15	2.67	0.41	3.33	2.85	0.41
	30.6	2.22	2.14	0.44	2.48	2.16	0.44	2.73	2.35	0.45	2.81	2.54	0.45	2.98	2.53	0.46	3.15	2.69	0.46
	35.0	2.08	2.02	0.48	2.32	2.03	0.49	2.56	2.21	0.50	2.64	2.39	0.50	2.8	2.38	0.51	2.95	2.53	0.51
40.0	1.76	1.66	0.45	1.96	1.80	0.46	2.16	1.97	0.46	2.23	2.13	0.46	2.36	2.12	0.47	2.50	2.26	0.47	
46.0	1.62	1.56	0.45	1.81	1.67	0.46	1.99	1.82	0.46	2.05	1.98	0.46	2.18	1.97	0.47	2.30	2.10	0.47	

# Model: ASU12RLS3Y

AFR	CFM	489
-----	-----	-----

		Indoor temperature																	
		64			70			75			80			85			90		
		54			60			63			67			71			73		
Outdoor temperature	°FDB	TC	SHC	IP	TC	SHC	IP	TC	SHC	IP	TC	SHC	IP	TC	SHC	IP	TC	SHC	IP
	°FWB	kBTu			kBTu			kBTu			kBTu			kBTu			kBTu		
		kW			kW			kW			kW			kW			kW		
	15	10.34	9.52	0.28	11.53	9.58	0.28	12.72	10.47	0.29	13.11	11.30	0.29	13.87	11.21	0.29	14.67	11.96	0.30
	23	10.26	9.44	0.33	11.44	9.47	0.33	12.62	10.34	0.35	13.01	11.19	0.34	13.77	11.12	0.34	14.56	11.85	0.35
	32	10.18	9.35	0.36	11.36	9.39	0.36	12.52	10.27	0.38	12.91	11.09	0.37	13.67	11.03	0.38	14.45	11.78	0.39
	41	10.10	9.30	0.39	11.27	9.37	0.39	12.42	10.21	0.41	12.81	11.02	0.40	13.57	10.98	0.40	14.34	11.68	0.41
	50	10.03	9.21	0.40	11.18	9.25	0.40	12.32	10.10	0.42	12.71	10.92	0.41	13.47	10.86	0.41	14.23	11.60	0.42
	59	9.95	9.16	0.41	11.10	9.23	0.41	12.22	10.05	0.44	12.61	10.85	0.42	13.37	10.81	0.43	14.12	11.50	0.44
	67	11.22	10.32	0.54	12.51	10.40	0.55	13.77	11.34	0.55	14.22	12.25	0.56	15.07	12.18	0.56	15.92	12.98	0.57
77	10.67	9.82	0.62	11.90	9.85	0.63	13.13	10.76	0.64	13.53	11.63	0.64	14.32	11.56	0.64	15.14	12.32	0.65	
87	10.09	9.27	0.69	11.25	9.31	0.70	12.41	10.18	0.71	12.78	10.98	0.71	13.57	10.94	0.72	14.32	11.67	0.73	
95	9.48	8.72	0.76	10.53	8.76	0.77	11.63	9.56	0.79	12.00	10.32	0.79	12.72	10.29	0.80	13.43	10.94	0.81	
104	8.01	7.78	0.71	8.93	7.82	0.72	9.82	8.51	0.73	10.13	9.20	0.74	10.74	9.16	0.74	11.35	9.78	0.75	
115	7.36	7.20	0.71	8.22	7.23	0.72	9.07	7.89	0.74	9.34	8.54	0.74	9.89	8.51	0.74	10.47	9.05	0.75	

AFR	m³/h	830
-----	------	-----

		Indoor temperature																	
		17.8			21.1			23.9			26.7			29.4			32.2		
		12.2			15.6			17.2			19.4			21.7			22.8		
Outdoor temperature	°CDB	TC	SHC	IP	TC	SHC	IP	TC	SHC	IP	TC	SHC	IP	TC	SHC	IP	TC	SHC	IP
	°CWB	kW			kW			kW			kW			kW			kW		
		kW			kW			kW			kW			kW			kW		
	-10.0	3.03	2.79	0.28	3.38	2.81	0.28	3.73	3.07	0.29	3.84	3.31	0.29	4.07	3.29	0.29	4.30	3.50	0.30
	-5.0	3.01	2.77	0.33	3.35	2.78	0.33	3.70	3.03	0.35	3.81	3.28	0.34	4.04	3.26	0.34	4.27	3.47	0.35
	0.0	2.98	2.74	0.36	3.33	2.75	0.36	3.67	3.01	0.38	3.78	3.25	0.37	4.01	3.23	0.38	4.23	3.45	0.39
	5.0	2.96	2.73	0.39	3.30	2.75	0.39	3.64	2.99	0.41	3.75	3.23	0.40	3.98	3.22	0.40	4.20	3.42	0.41
	10.0	2.94	2.70	0.40	3.28	2.71	0.40	3.61	2.96	0.42	3.73	3.20	0.41	3.95	3.18	0.41	4.17	3.40	0.42
	15.0	2.92	2.68	0.41	3.25	2.71	0.41	3.58	2.94	0.44	3.70	3.18	0.42	3.92	3.17	0.43	4.14	3.37	0.44
	19.4	3.29	3.03	0.54	3.67	3.05	0.55	4.04	3.32	0.55	4.17	3.59	0.56	4.42	3.57	0.56	4.67	3.80	0.57
25.0	3.13	2.88	0.62	3.49	2.89	0.63	3.85	3.15	0.64	3.97	3.41	0.64	4.20	3.39	0.64	4.44	3.61	0.65	
30.6	2.96	2.72	0.69	3.30	2.73	0.70	3.64	2.98	0.71	3.75	3.22	0.71	3.98	3.21	0.72	4.20	3.42	0.73	
35.0	2.78	2.56	0.76	3.09	2.57	0.77	3.41	2.80	0.79	3.52	3.03	0.79	3.73	3.02	0.80	3.94	3.21	0.81	
40.0	2.35	2.28	0.71	2.62	2.29	0.72	2.88	2.49	0.73	2.97	2.70	0.74	3.15	2.68	0.74	3.33	2.87	0.75	
46.0	2.16	2.11	0.71	2.41	2.12	0.72	2.66	2.31	0.74	2.74	2.50	0.74	2.90	2.49	0.74	3.07	2.65	0.75	

# Model: ASU15RLS3Y

AFR	CFM	547
-----	-----	-----

		Indoor temperature																	
		64			70			75			80			85			90		
		54			60			63			67			71			73		
Outdoor temperature	°FDB	TC	SHC	IP	TC	SHC	IP	TC	SHC	IP	TC	SHC	IP	TC	SHC	IP	TC	SHC	IP
	°FWB	kBTu			kBTu			kBTu			kBTu			kBTu			kBTu		
	15	12.72	9.80	0.36	14.18	10.92	0.36	15.63	12.04	0.38	16.10	12.40	0.37	17.04	13.13	0.37	18.02	13.88	0.38
	23	12.53	9.62	0.39	13.95	10.72	0.39	15.38	11.82	0.41	15.85	12.18	0.40	16.78	12.90	0.40	17.75	13.63	0.42
	32	12.33	9.49	0.40	13.73	10.57	0.41	15.14	11.65	0.43	15.60	12.01	0.42	16.52	12.72	0.42	17.47	13.45	0.43
	41	12.13	9.34	0.41	13.51	10.41	0.41	14.89	11.47	0.43	15.35	11.82	0.42	16.26	12.52	0.42	17.19	13.24	0.44
	50	11.93	9.18	0.42	13.29	10.23	0.42	14.65	11.27	0.45	15.10	11.62	0.43	16.00	12.31	0.44	16.91	13.01	0.45
	59	11.73	9.01	0.45	13.07	10.04	0.45	14.41	11.07	0.48	14.85	11.41	0.46	15.74	12.10	0.46	16.64	12.78	0.48
	67	13.48	11.10	0.72	15.01	11.17	0.74	16.55	12.15	0.75	17.06	13.14	0.75	18.08	13.07	0.76	19.11	13.95	0.76
	77	12.86	10.57	0.82	14.33	10.64	0.83	15.80	11.59	0.84	16.27	12.50	0.84	17.23	12.47	0.85	18.22	13.28	0.86
	87	12.18	10.00	0.91	13.58	10.07	0.92	14.98	10.99	0.94	15.42	11.87	0.95	16.34	11.84	0.95	17.30	12.61	0.96
	95	11.46	9.40	1.01	12.76	9.48	1.02	14.06	10.32	1.03	14.50	11.17	1.04	15.35	11.10	1.05	16.24	11.84	1.06
	104	10.06	8.28	0.99	11.22	8.31	1.01	12.35	9.09	1.02	12.73	9.79	1.02	13.51	9.76	1.03	14.26	10.39	1.05
	115	9.18	7.54	0.97	10.20	7.57	0.99	11.26	8.28	1.01	11.60	8.91	1.01	12.32	8.88	1.02	13.00	9.48	1.03

AFR	m³/h	930
-----	------	-----

		Indoor temperature																	
		17.8			21.1			23.9			26.7			29.4			32.2		
		12.2			15.6			17.2			19.4			21.7			22.8		
Outdoor temperature	°CDB	TC	SHC	IP	TC	SHC	IP	TC	SHC	IP	TC	SHC	IP	TC	SHC	IP	TC	SHC	IP
	°CWB	kW			kW			kW			kW			kW			kW		
	-10.0	3.73	2.87	0.36	4.15	3.20	0.36	4.58	3.53	0.38	4.72	3.63	0.37	5.00	3.85	0.37	5.28	4.07	0.38
	-5.0	3.67	2.82	0.39	4.09	3.14	0.39	4.51	3.46	0.41	4.65	3.57	0.40	4.92	3.78	0.40	5.20	4.00	0.42
	0.0	3.61	2.78	0.40	4.02	3.10	0.41	4.44	3.42	0.43	4.57	3.52	0.42	4.84	3.73	0.42	5.12	3.94	0.43
	5.0	3.56	2.74	0.41	3.96	3.05	0.41	4.37	3.36	0.43	4.50	3.46	0.42	4.77	3.67	0.42	5.04	3.88	0.44
	10.0	3.50	2.69	0.42	3.90	3.00	0.42	4.29	3.30	0.45	4.43	3.41	0.43	4.69	3.61	0.44	4.96	3.81	0.45
	15.0	3.44	2.64	0.45	3.83	2.94	0.45	4.22	3.24	0.48	4.35	3.34	0.46	4.61	3.54	0.46	4.88	3.75	0.48
	19.4	3.95	3.25	0.72	4.40	3.27	0.74	4.85	3.56	0.75	5.00	3.85	0.75	5.30	3.83	0.76	5.60	4.09	0.76
	25.0	3.77	3.10	0.82	4.20	3.12	0.83	4.63	3.40	0.84	4.77	3.66	0.84	5.05	3.65	0.85	5.34	3.89	0.86
	30.6	3.57	2.93	0.91	3.98	2.95	0.92	4.39	3.22	0.94	4.52	3.48	0.95	4.79	3.47	0.95	5.07	3.70	0.96
	35.0	3.36	2.76	1.01	3.74	2.78	1.02	4.12	3.02	1.03	4.25	3.27	1.04	4.50	3.25	1.05	4.76	3.47	1.06
	40.0	2.95	2.43	0.99	3.29	2.44	1.01	3.62	2.66	1.02	3.73	2.87	1.02	3.96	2.86	1.03	4.18	3.05	1.05
	46.0	2.69	2.21	0.97	2.99	2.22	0.99	3.30	2.43	1.01	3.40	2.61	1.01	3.61	2.60	1.02	3.81	2.78	1.03

## 5-2. Heating capacity

### ■ Model: ASU9RLS3Y

AFR	CFM	489
-----	-----	-----

Outdoor temperature		Indoor temperature									
		°FDB	°FWB	60		65		70		75	
				TC kBtu/h	IP kW	TC kBtu/h	IP kW	TC kBtu/h	IP kW	TC kBtu/h	IP kW
-5	-7	14.7	2.01	14.3	2.05	14.0	2.09	13.3	2.17		
5	3	16.1	2.02	15.7	2.06	15.4	2.10	14.6	2.19		
14	12	16.8	1.98	16.4	2.02	16.0	2.07	15.2	2.15		
23	19	18.3	1.95	17.9	1.99	17.5	2.03	16.6	2.11		
32	28	18.8	1.91	18.4	1.95	17.9	1.99	17.0	2.07		
41	37	21.3	1.88	20.8	1.92	20.3	1.95	19.3	2.03		
47	43	23.1	1.85	22.6	1.89	22.0	1.93	20.9	2.01		
50	47	25.5	1.84	24.9	1.88	24.3	1.91	23.1	1.99		
59	50	26.5	1.63	25.8	1.67	25.2	1.70	23.9	1.77		

AFR	m <sup>3</sup> /h	830
-----	-------------------	-----

Outdoor temperature		Indoor temperature									
		°CDB	°CWB	15.6		18.3		21.1		23.9	
				TC kW	IP	TC kW	IP	TC kW	IP	TC kW	IP
-20.6	-21.7	4.31	2.01	4.20	2.05	4.10	2.09	3.90	2.17		
-15.0	-16.1	4.73	2.02	4.61	2.06	4.50	2.10	4.28	2.19		
-10.0	-11.1	4.91	1.98	4.80	2.02	4.68	2.07	4.45	2.15		
-5.0	-7.2	5.38	1.95	5.25	1.99	5.12	2.03	4.86	2.11		
0.0	-2.2	5.52	1.91	5.39	1.95	5.26	1.99	5.00	2.07		
5.0	2.8	6.25	1.88	6.10	1.92	5.95	1.95	5.65	2.03		
8.3	6.1	6.77	1.85	6.61	1.89	6.45	1.93	6.13	2.01		
10.0	8.3	7.48	1.84	7.30	1.88	7.13	1.91	6.77	1.99		
15.0	10.0	7.75	1.63	7.57	1.67	7.38	1.70	7.02	1.77		

### ■ Model: ASU12RLS3Y

AFR	CFM	489
-----	-----	-----

Outdoor temperature		Indoor temperature									
		°FDB	°FWB	60		65		70		75	
				TC kBtu/h	IP kW	TC kBtu/h	IP kW	TC kBtu/h	IP kW	TC kBtu/h	IP kW
-5	-7	15.8	2.01	15.4	2.05	15.0	2.09	14.3	2.17		
5	3	17.4	2.02	17.0	2.06	16.6	2.10	15.8	2.19		
14	12	18.3	1.98	17.8	2.03	17.4	2.07	16.5	2.15		
23	19	20.0	1.95	19.5	1.99	19.0	2.03	18.1	2.11		
32	28	20.6	1.92	20.1	1.96	19.6	2.00	18.6	2.08		
41	37	22.5	1.88	21.9	1.92	21.4	1.96	20.3	2.04		
47	43	23.2	1.86	22.7	1.90	22.1	1.94	21.0	2.02		
50	47	25.6	1.85	25.0	1.89	24.4	1.93	23.2	2.00		
59	50	26.6	1.64	25.9	1.68	25.3	1.71	24.0	1.78		

AFR	m <sup>3</sup> /h	830
-----	-------------------	-----

Outdoor temperature		Indoor temperature									
		°CDB	°CWB	15.6		18.3		21.1		23.9	
				TC kW	IP	TC kW	IP	TC kW	IP	TC kW	IP
-20.6	-21.7	4.63	2.01	4.52	2.05	4.41	2.09	4.19	2.17		
-15.0	-16.1	5.11	2.02	4.99	2.06	4.86	2.10	4.62	2.19		
-10.0	-11.1	5.36	1.98	5.23	2.03	5.10	2.07	4.85	2.15		
-5.0	-7.2	5.86	1.95	5.72	1.99	5.58	2.03	5.30	2.11		
0.0	-2.2	6.03	1.92	5.88	1.96	5.74	2.00	5.45	2.08		
5.0	2.8	6.58	1.88	6.43	1.92	6.27	1.96	5.96	2.04		
8.3	6.1	6.80	1.86	6.64	1.90	6.48	1.94	6.15	2.02		
10.0	8.3	7.52	1.85	7.34	1.89	7.16	1.93	6.80	2.00		
15.0	10.0	7.79	1.64	7.60	1.68	7.42	1.71	7.05	1.78		

# Model: ASU15RLS3Y

AFR	CFM	547
-----	-----	-----

		Indoor temperature									
		°FDB	60		65		70		75		
Outdoor temperature	°FDB	°FWB	TC	IP	TC	IP	TC	IP	TC	IP	
			kBtu/h	kW	kBtu/h	kW	kBtu/h	kW	kBtu/h	kW	
	-5	-7	19.6	2.63	19.1	2.69	18.6	2.74	17.7	2.85	
	5	3	22.0	2.64	21.5	2.70	21.0	2.75	19.9	2.86	
	14	12	22.7	2.53	22.2	2.58	21.6	2.63	20.5	2.74	
	23	19	23.3	2.41	22.8	2.46	22.2	2.51	21.1	2.61	
	32	28	24.0	2.30	23.4	2.34	22.9	2.39	21.7	2.49	
	41	37	24.7	2.18	24.1	2.22	23.5	2.27	22.3	2.36	
	47	43	25.1	2.10	24.5	2.15	23.9	2.19	22.7	2.28	
	50	47	26.1	1.97	25.5	2.01	24.9	2.05	23.6	2.13	
59	50	27.2	1.75	26.5	1.79	25.9	1.82	24.6	1.89		

AFR	m <sup>3</sup> /h	930
-----	-------------------	-----

		Indoor temperature									
		°CDB	15.6		18.3		21.1		23.9		
Outdoor temperature	°CDB	°CWB	TC	IP	TC	IP	TC	IP	TC	IP	
			kW		kW		kW		kW		
	-20.6	-21.7	5.73	2.63	5.60	2.69	5.46	2.74	5.19	2.85	
	-15.0	-16.1	6.46	2.64	6.31	2.70	6.15	2.75	5.84	2.86	
	-10.0	-11.1	6.65	2.53	6.49	2.58	6.33	2.63	6.02	2.74	
	-5.0	-7.2	6.84	2.41	6.68	2.46	6.52	2.51	6.19	2.61	
	0.0	-2.2	7.04	2.30	6.87	2.34	6.70	2.39	6.37	2.49	
	5.0	2.8	7.23	2.18	7.06	2.22	6.88	2.27	6.54	2.36	
	8.3	6.1	7.35	2.10	7.18	2.15	7.00	2.19	6.65	2.28	
	10.0	8.3	7.66	1.97	7.47	2.01	7.29	2.05	6.93	2.13	
15.0	10.0	7.97	1.75	7.78	1.79	7.59	1.82	7.21	1.89		



# 6. Fan performance

## 6-1. Air velocity distributions

### ■ Models: ASU9RLS3Y and ASU12RLS3Y

Measuring conditions	Fan speed	Operation mode
	HIGH	FAN

Top view  
Vertical airflow direction louver: Up  
Horizontal airflow direction louver: Center

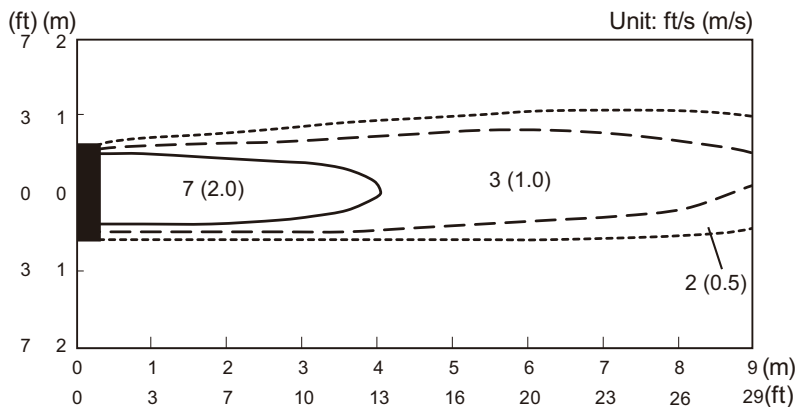

Top view  
Vertical airflow direction louver: Up  
Horizontal airflow direction louver: Left & Right

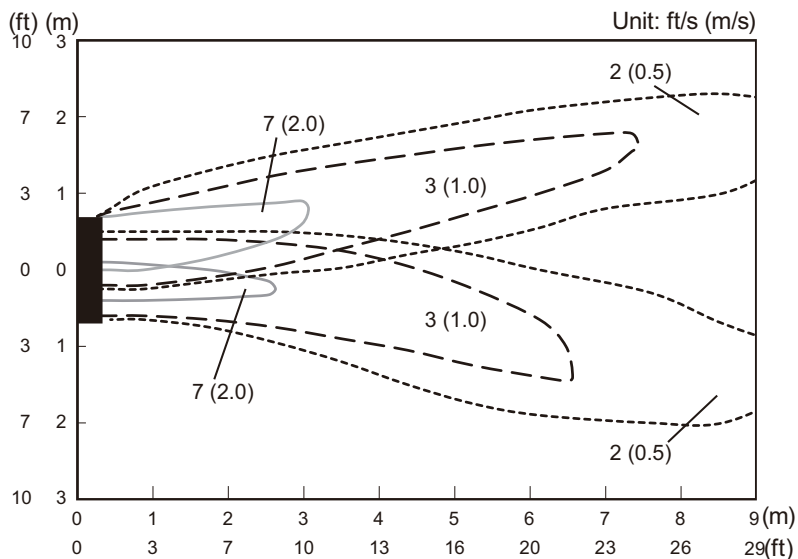

Side view  
Vertical airflow direction louver: Up  
Horizontal airflow direction louver: Center

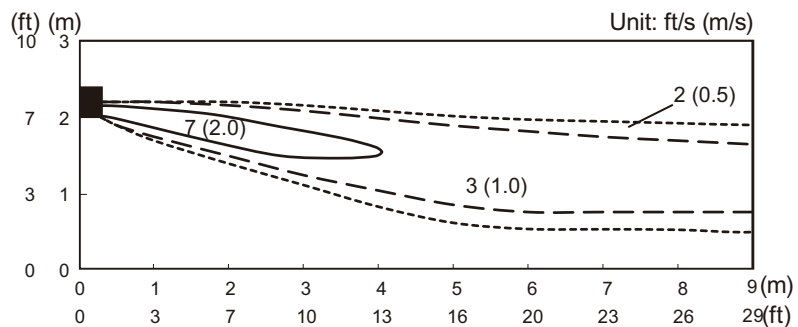

Side view  
Vertical airflow direction louver: Down  
Horizontal airflow direction louver: Center

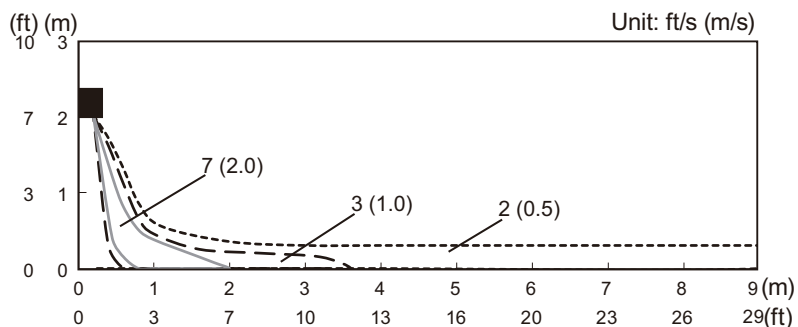

Model: ASU15RLS3Y

WALL MOUNTED  
ASU9-15RLS3Y

WALL MOUNTED  
ASU9-15RLS3Y

Measuring conditions	Fan speed	Operation mode
	HIGH	FAN

Top view  
Vertical airflow direction louver: Up  
Horizontal airflow direction louver: Center

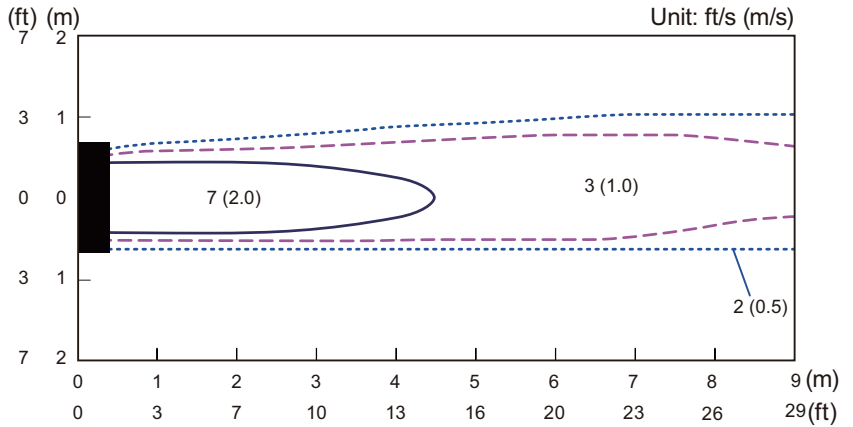

Top view  
Vertical airflow direction louver: Up  
Horizontal airflow direction louver: Left & Right

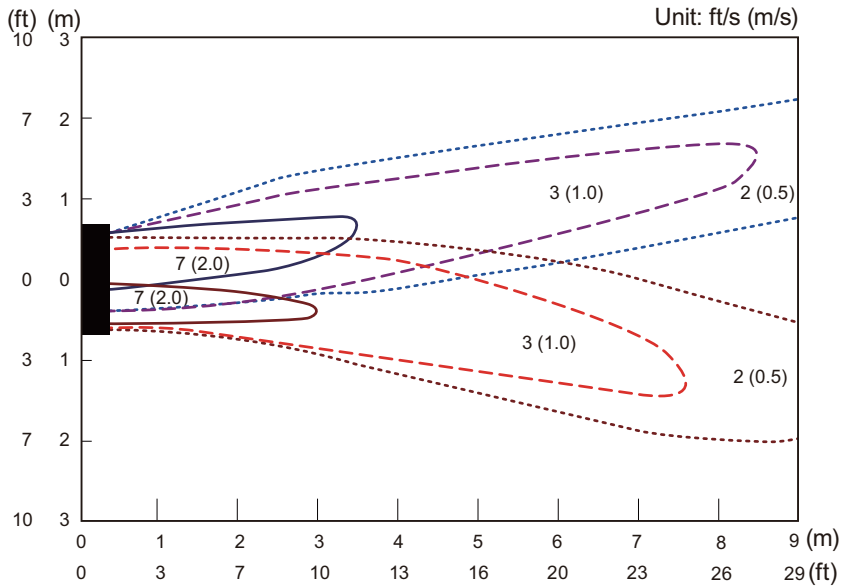

Side view  
Vertical airflow direction louver: Up  
Horizontal airflow direction louver: Center

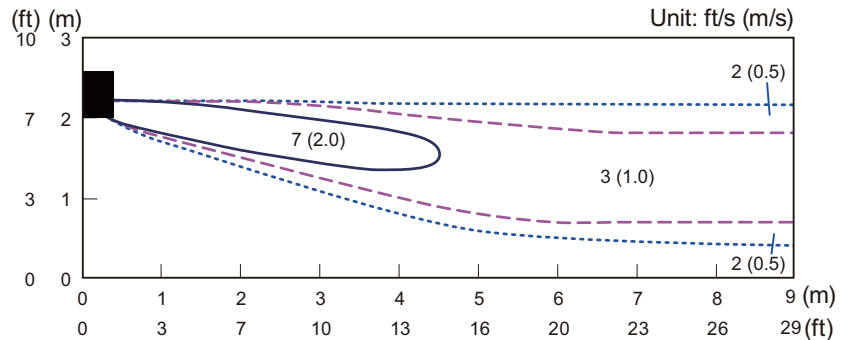

Side view  
Vertical airflow direction louver: Down  
Horizontal airflow direction louver: Center

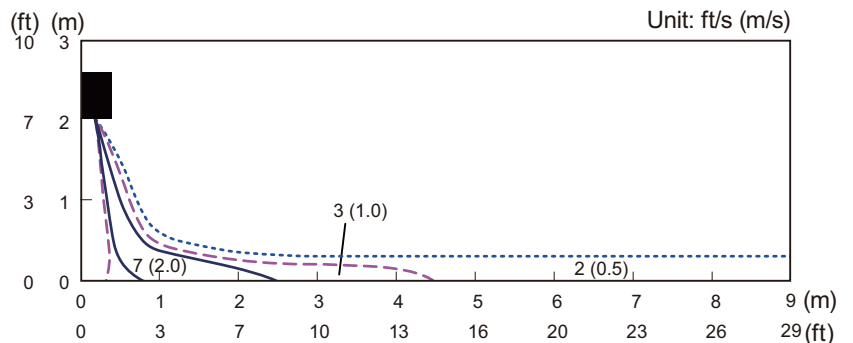

## 6-2. Airflow

### ■ Models: ASU9RLS3Y and ASU12RLS3Y

#### ● Cooling

Fan speed	Airflow	
HIGH	m <sup>3</sup> /h	830
	l/s	231
	CFM	489
MED	m <sup>3</sup> /h	680
	l/s	189
	CFM	400
LOW	m <sup>3</sup> /h	580
	l/s	161
	CFM	341
QUIET	m <sup>3</sup> /h	380
	l/s	106
	CFM	224

#### ● Heating

Fan speed	Airflow	
HIGH	m <sup>3</sup> /h	830
	l/s	231
	CFM	489
MED	m <sup>3</sup> /h	680
	l/s	189
	CFM	400
LOW	m <sup>3</sup> /h	580
	l/s	161
	CFM	341
QUIET	m <sup>3</sup> /h	380
	l/s	106
	CFM	224

## ■ Model: ASU15RLS3Y

### ● Cooling

Fan speed	Airflow	
HIGH	m <sup>3</sup> /h	930
	l/s	258
	CFM	547
MED	m <sup>3</sup> /h	780
	l/s	217
	CFM	459
LOW	m <sup>3</sup> /h	630
	l/s	175
	CFM	371
QUIET	m <sup>3</sup> /h	440
	l/s	122
	CFM	259

### ● Heating

Fan speed	Airflow	
HIGH	m <sup>3</sup> /h	930
	l/s	258
	CFM	547
MED	m <sup>3</sup> /h	780
	l/s	217
	CFM	459
LOW	m <sup>3</sup> /h	630
	l/s	175
	CFM	371
QUIET	m <sup>3</sup> /h	500
	l/s	139
	CFM	294

# 7. Operation noise (sound pressure)

## 7-1. Noise level curve

### Model: ASU9RLS3Y

#### Cooling

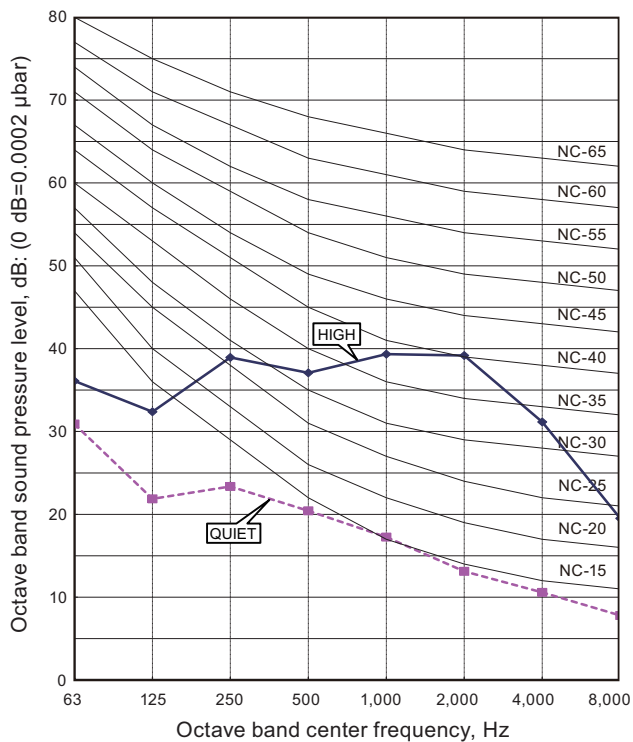

#### Heating

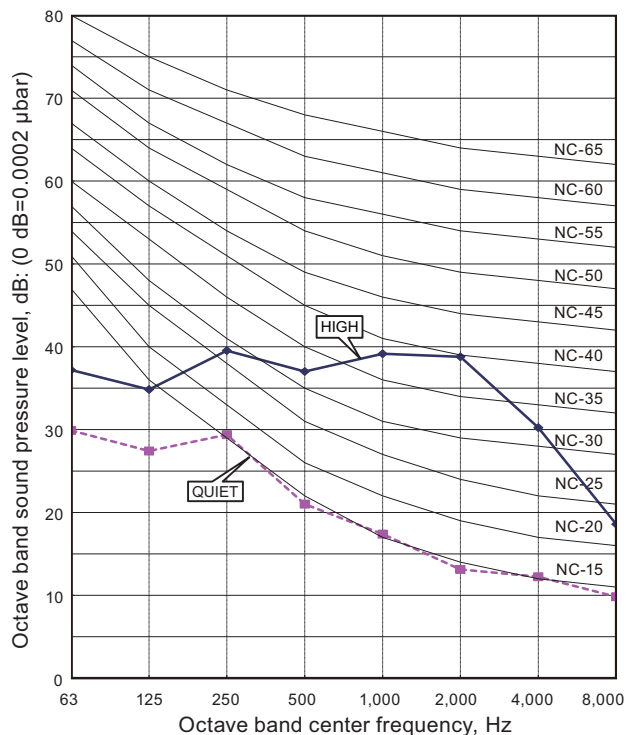

### Model: ASU12RLS3Y

#### Cooling

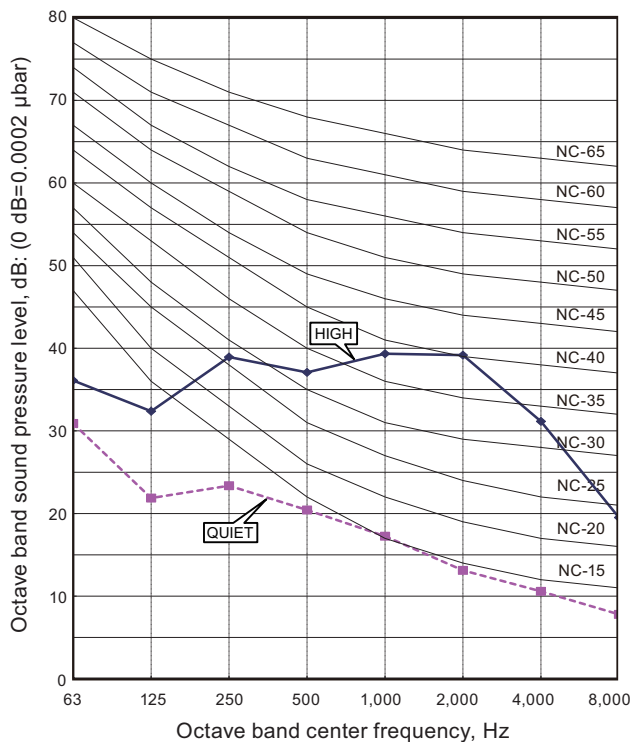

#### Heating

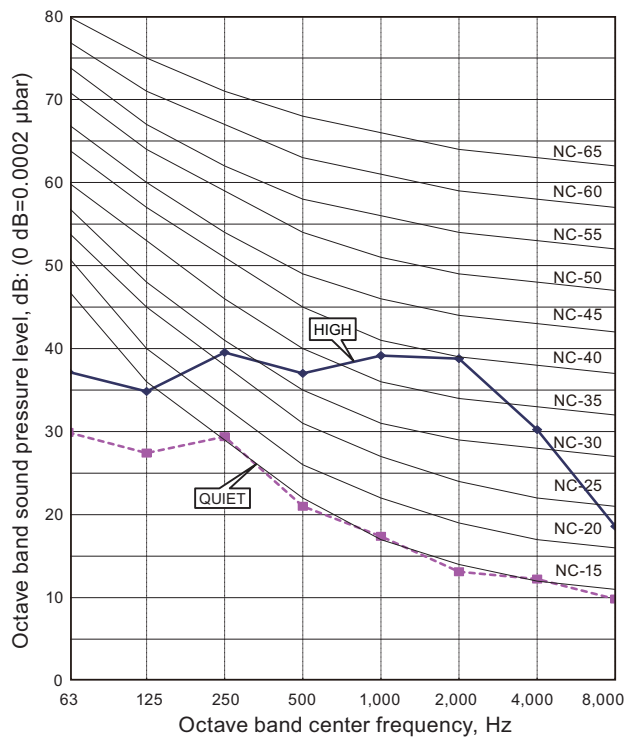

# Model: ASU15RLS3Y

## ● Cooling

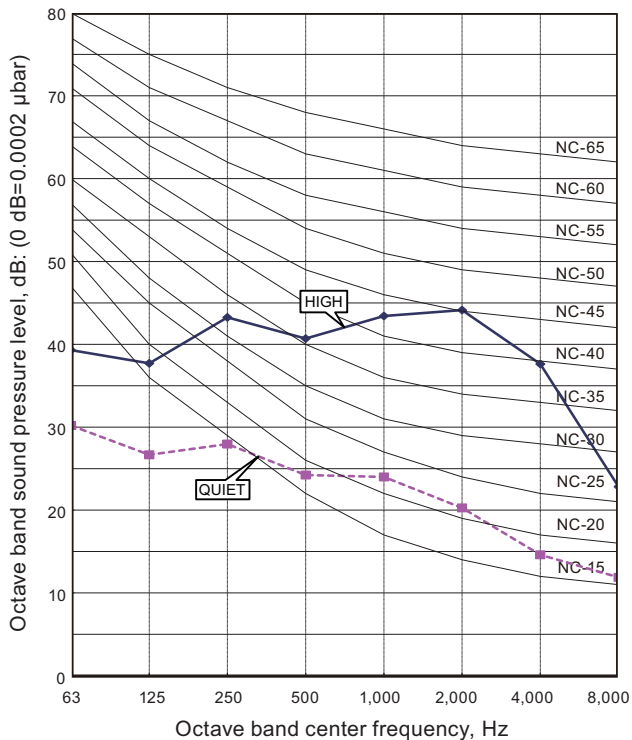

## ● Heating

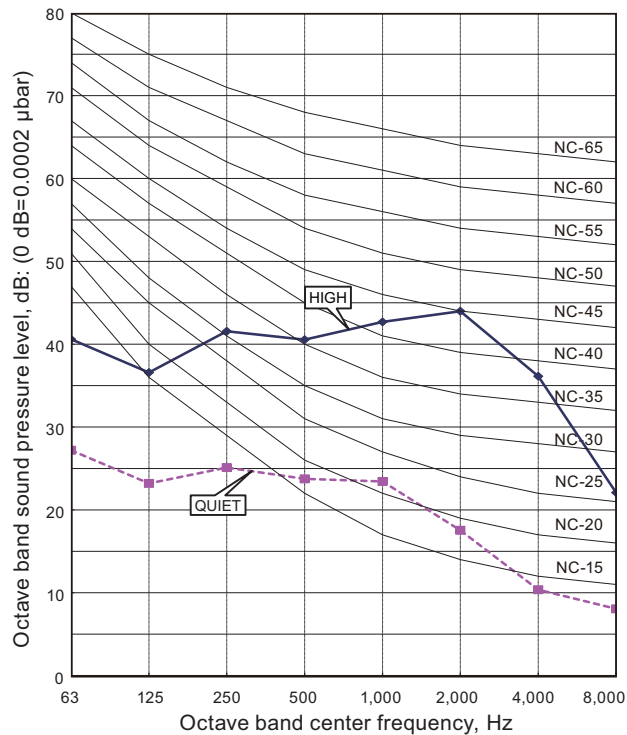

## 7-2. Sound level check point

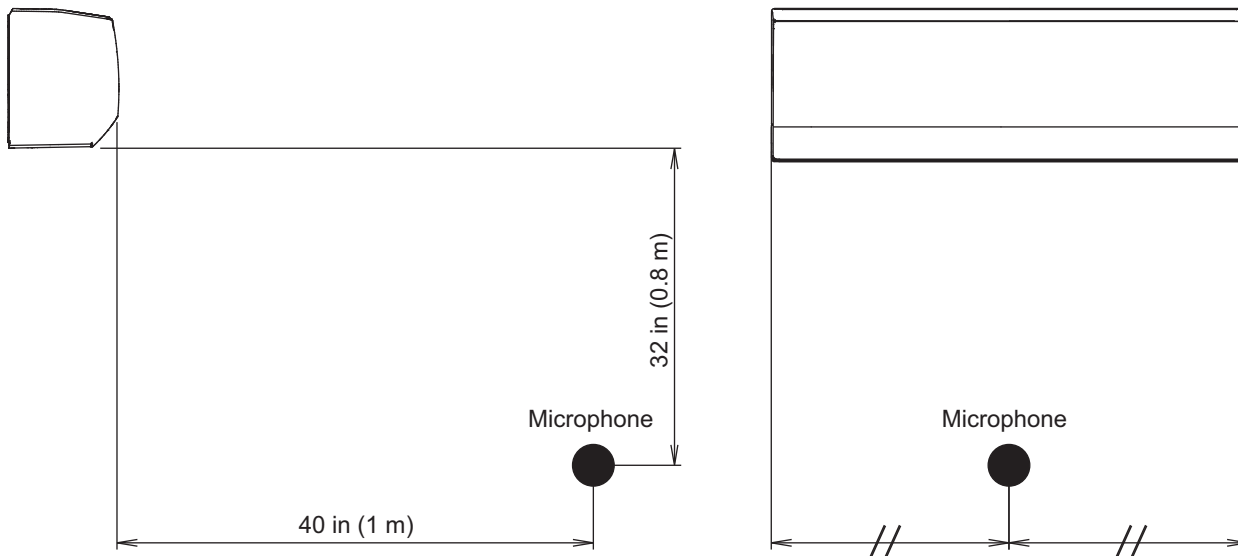

**NOTE:** Detailed shape of the actual indoor unit might be slightly different from the one illustrated above.

## 8. Safety devices

Type of protection	Protection form		Model		
			ASU9RLS3Y	ASU12RLS3Y	ASU15RLS3Y
Circuit protection	Current fuse (PCB*)		250 V, 3.15 A		
Fan motor protection	Thermal protector program	Activate	302±27 °F (150±15 °C) Fan motor speed down		
		Reset	248±27 °F (120±15 °C) Fan motor speed recover		

\*PCB: Printed Circuit Board

## 9. External input and output

With using external input and output functions, this product can be operated inter-connectedly with an external device.

Connector	Input	Output	Remarks
CNA01	Control input	—	See external input/output settings for details.
CNB01	—	Operation status output	
CNB02	—	Error status output	

### 9-1. External input

With using external input function, some functions on this product can be controlled from an external device.

- “Operation/Stop” mode can be selected with function setting of indoor unit.
- A twisted pair cable (22AWG) should be used. Maximum length of cable is 492 ft (150 m).
- The wire connection should be separate from the power cable line.

#### ■ Control input (Operation/Stop or Forced stop)

The air conditioner can be remotely operated by means of the following on-site work.

Unit operation is started at the following contents by adding the contact input of a commercial on/off switch to a connector on the external control PCB and turning it on.

Unit operation	Initial setting after power is on	Starting mode other than initial setting
Operation mode	Auto changeover	Mode at previous operation
Set temperature	75 °F (24 °C)	Temperature at previous operation
Airflow mode	AUTO	Mode at previous operation
Air direction (swing)	Standard air direction (swing: off)	Air direction at previous operation



• **Circuit diagram example**

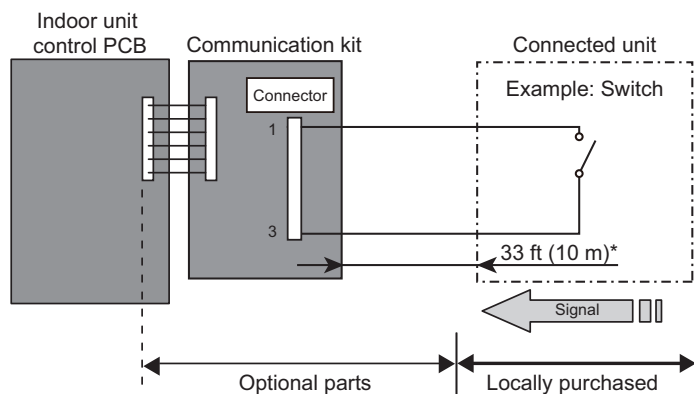

- Contact capacity: DC 24 V or more, 10 mA or more.
- \*: Make the distance from the PCB to the connected unit within 33 ft (10 m).
- Use non-polar relays and switches.

– When function setting is “Operation/Stop” mode

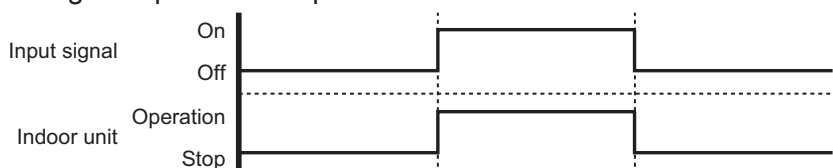

– When function setting is “Forced stop” mode

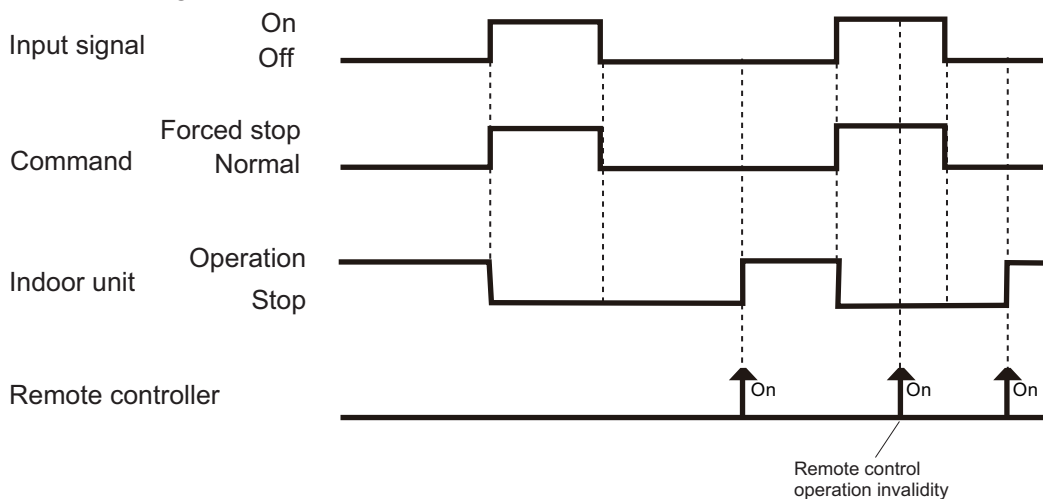

– When function setting is "Operation/Stop" mode 2

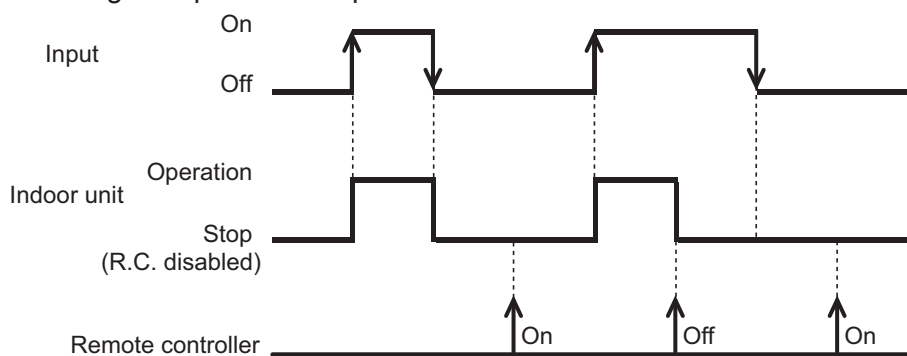

**NOTE:** When "Operation/Stop" mode 2 function is used with forming a remote controller group, connect the same equipment to each indoor unit within the group.

- **Optional part**

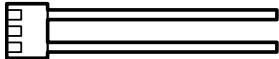
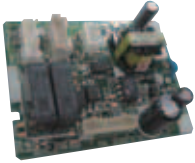
Part name	Model name	Exterior
External connect kit	UTY-XWZXZ5	External input wire 
Communication kit	UTY-TWBXF1	

\* For operating the external function, the wall mounted type requires the communication kit in addition to the wire (UTY-XWZXZ5).

## 9-2. External output

With using external output function, operating status of this product can be transmitted to the external device, and also, this product can be inter-connected with the external device.

### ■ Operation status output

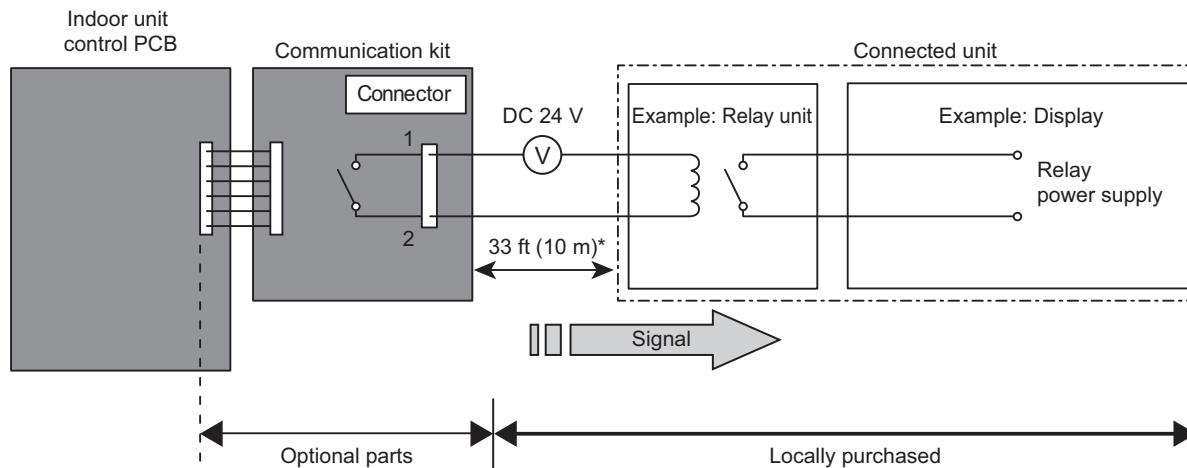

#### ● Circuit diagram example

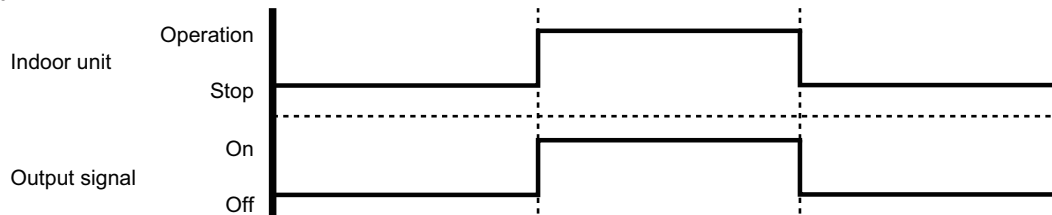

- \*: Make the distance from the PCB to the connected unit within 33 ft (10 m).
- Relay spec: Max. DC 24 V, 10 mA to less than 500 mA.

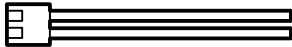

#### ● Optional part

Part name	Model name	Exterior
External connect kit	UTY-XWZXZ5	External output wire 
Communication kit	UTY-TWBXF1	

\* For operating the external function, the wall mounted type requires the communication kit in addition to the wire (UTY-XWZXZ5).

## ■ Error status output

### ● Circuit diagram example

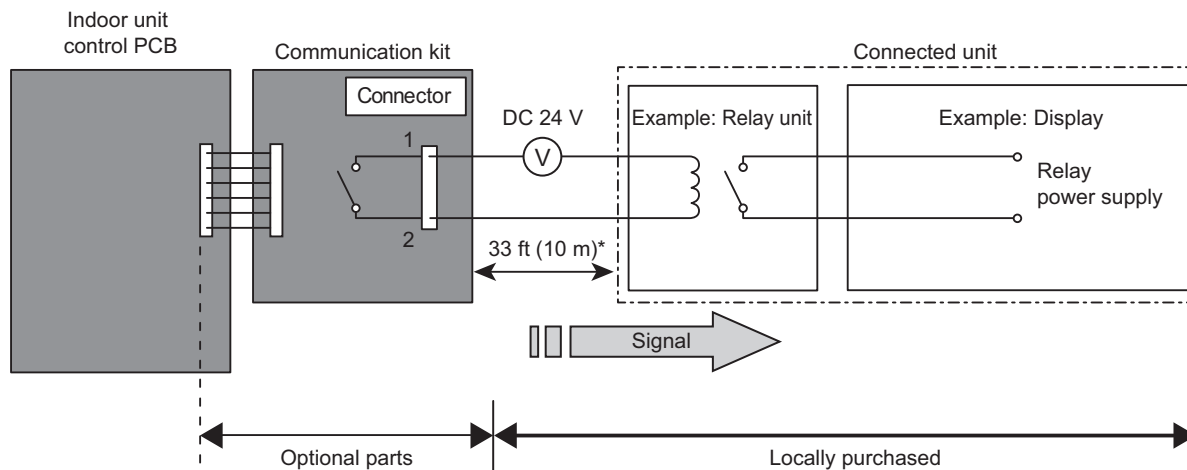

- \*: Make the distance from the PCB to the connected unit within 33 ft (10 m).
- Relay spec: Max. DC 24 V, 10 mA to less than 500 mA.

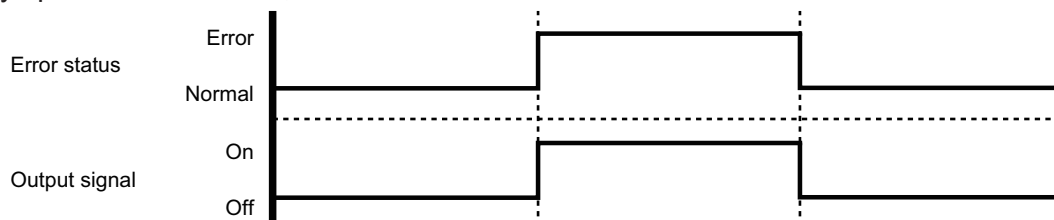

### ● Optional part

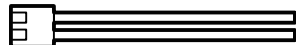
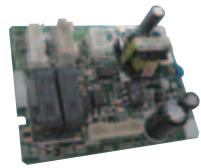
Part name	Model name	Exterior
External connect kit	UTY-XWZXZ5	External output wire 
Communication kit	UTY-TWBXF1	

\* For operating the external function, the wall mounted type requires the communication kit in addition to the wire (UTY-XWZXZ5).

# 10. Remote controller

## 10-1. Wireless remote controller

### Overview

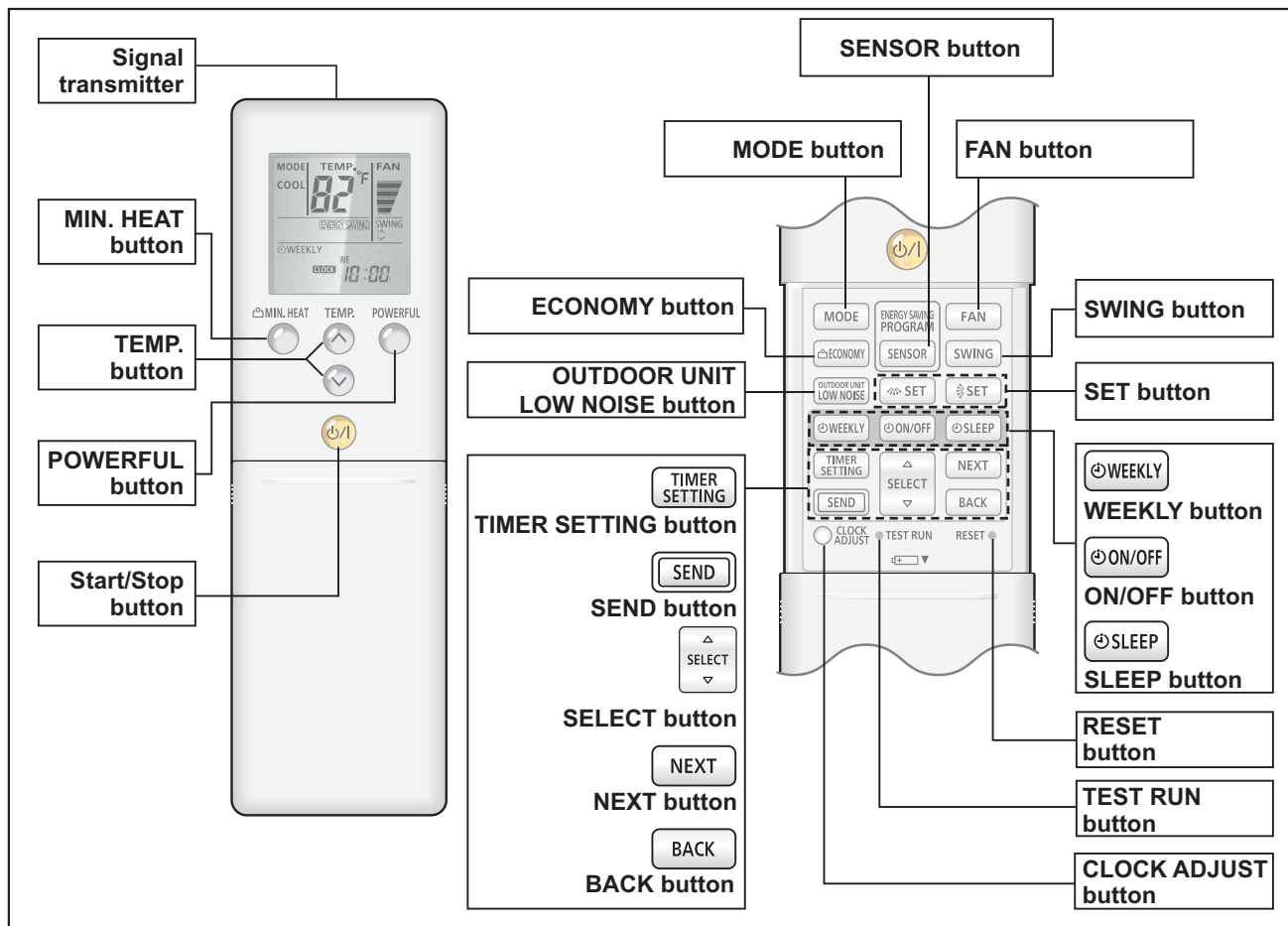

**NOTE:** Functions may differ by type of the indoor unit. For details, refer to the operation manual.

### Display panel

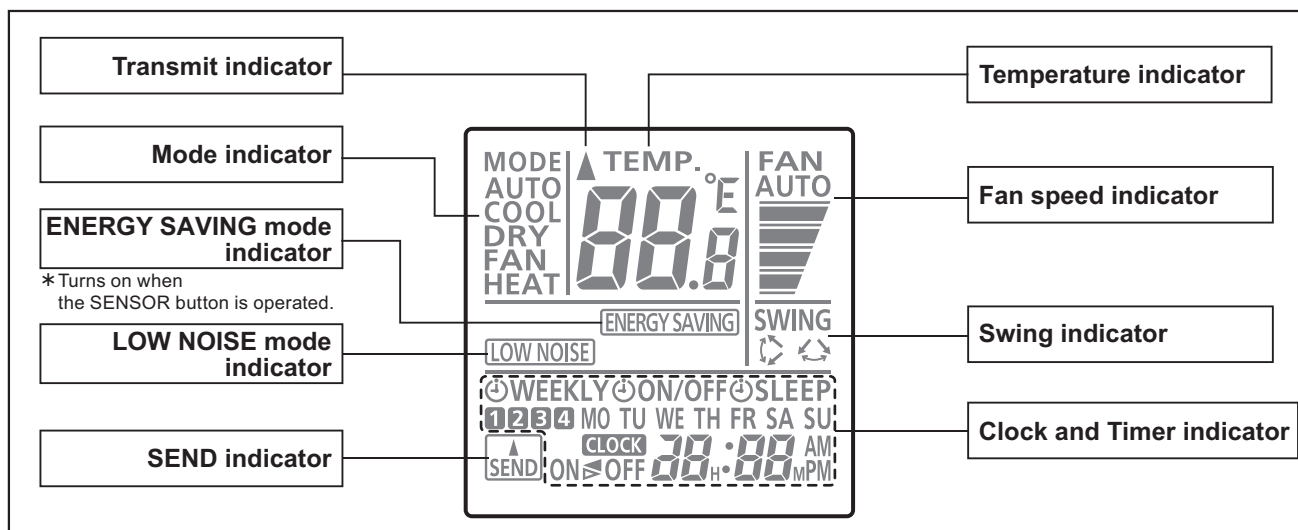

To facilitate explanation, the accompanying illustration has been drawn to show all possible indicators; in actual operation, however, the display will only show those indicators appropriate to the current operation.

# Specifications

## Controller

Unit: in (mm)

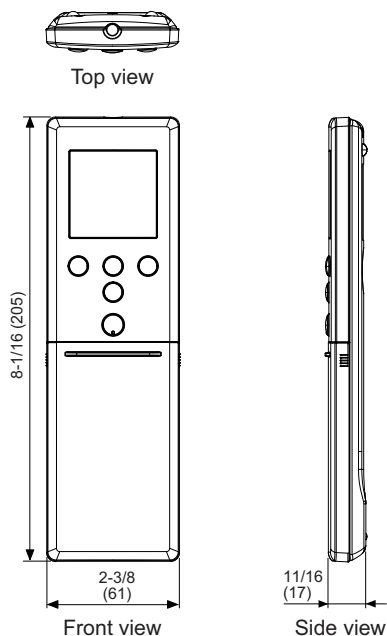

Size (H × W × D)	in (mm)	8-1/16 × 2-3/8 × 11/16 (205 × 61 × 17)
Weight	oz (g)	4.3 (122) (without batteries)

## Holder

Unit: in (mm)

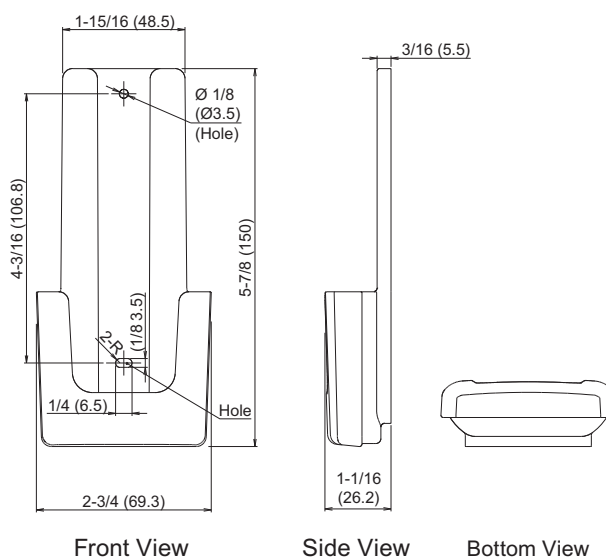

Size (H × W × D)	in (mm)	5-7/8 × 2-3/4 × 1-1/16 (150 × 69.3 × 26.2)
Weight	oz (g)	1 (27)

## 11. Function settings

To adjust the functions of this product according to the installation environment, various types of function settings are available.

**NOTE:** Incorrect settings can cause a product malfunction.

### 11-1. Function settings by using remote controller

Some function settings can be changed on the remote controller. After confirming the setting procedure and the content of each function setting, select appropriate functions for your installation environment.

#### ■ Setting procedure by using wireless remote controller

The function number and the associated setting value are displayed on the LCD of the remote controller. Follow the instructions written in the local setup procedure supplied with the remote controller, and select appropriate setting according to the installation environment.

**Before connecting the power supply of the indoor unit, reconfirm following items:**

- Cover for the electrical enclosure on the outdoor unit is in place.
- There is no wiring mistake.
- Piping air tight test and vacuuming have been performed firmly.
- All the necessary wiring work for outdoor unit has been finished.

After reconfirming the items listed above, connect the power supply of the indoor unit.

**NOTES:**

- Settings will not be changed if invalid numbers or setting values are selected.
- When optional wired remote controller is used, refer to the installation manual enclosed with the remote controller.

#### Entering function setting mode:

While pressing the POWERFUL button and TEMP. (^) button simultaneously, press the RESET button to enter the function setting mode.

#### Selecting the function number and setting value:

1. Press the TEMP. (^) (v) buttons to select the function number. To switch between the left and right digits, press the MIN. HEAT button.
2. Press the POWERFUL button to proceed to value setting. To return the function number selection, press the POWERFUL button again.
3. Press the TEMP. (^) (v) buttons to select the setting value. To switch between the left and right digits, press the MIN. HEAT button.
4. Press the MODE button once to send the function setting information. Confirm that you hear the beep sound.
5. Press the START/STOP button to fix the function setting. Confirm that you hear the beep sound.
6. Press the RESET button to end the function setting mode.
7. After completing the function setting, be sure to disconnect the power supply and then reconnect it.

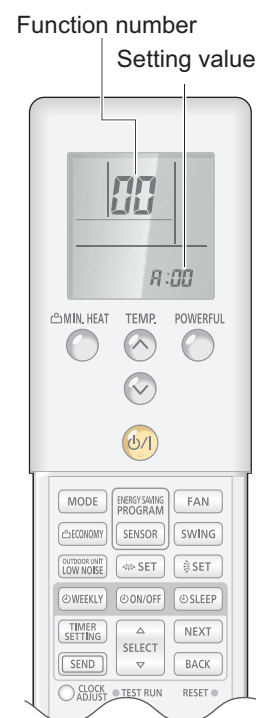

#### ⚠ CAUTION

After disconnecting the power supply, wait 30 seconds or more before reconnecting it. The function setting will not become active unless the power supply is disconnected and then reconnected.

## ■ Contents of function setting

Each function setting listed in this section is adjustable in accordance with the installation environment.

**NOTE:** Setting will not be changed if invalid numbers or setting values are selected.

### ● Function setting list

	Function no.	Functions
1)	11	Filter sign
2)	30/31	Room temperature control for indoor unit sensor
3)	35/36	Room temperature control for wired remote controller sensor
4)	40	Auto restart
5)	42	Room temperature sensor switching
6)	44	Remote controller custom code
7)	46	External input control
8)	48	Room temperature sensor switching (Aux.)
9)	49	Indoor unit fan control for energy saving for cooling
10)	95	Heat insulation condition (building insulation)

#### 1) Filter sign

Select appropriate intervals for displaying the filter sign on the indoor unit according to the estimated amount of dust in the air of the room.

If the indication is not required, select "No indication" (03).

Function number	Setting value	Setting description	Factory setting
11	00	Standard (400 hours)	
	01	Long interval (1,000 hours)	
	02	Short interval (200 hours)	
	03	No indication	◆



## 2) Room temperature control for indoor unit sensor

**NOTE:** Before performing this setting, refer to Function 95.

Depending on the installed environment, correction of the room temperature sensor may be required. Select the appropriate control setting according to the installed environment.

The temperature correction values show the difference from the Standard setting "00" (manufacturer's recommended value).

\*When Function 95-01 (High insulation) is set, the Standard setting "00" will be the same as "No correction 0.0 °F (0.0 °C)" (01).

Function number		Setting value	Setting description	Factory setting	
30 (For cooling)	31 (For heating)	00	Standard setting*	◆	
		01	No correction 0.0 °F (0.0 °C)		
		02	-1 °F (-0.5 °C)	More cooling Less heating	
		03	-2 °F (-1.0 °C)		
		04	-3 °F (-1.5 °C)		
		05	-4 °F (-2.0 °C)		
		06	-5 °F (-2.5 °C)		
		07	-6 °F (-3.0 °C)		
		08	-7 °F (-3.5 °C)		
		09	-8 °F (-4.0 °C)		
		10	+1 °F (+0.5 °C)	Less cooling More heating	
		11	+2 °F (+1.0 °C)		
		12	+3 °F (+1.5 °C)		
		13	+4 °F (+2.0 °C)		
		14	+5 °F (+2.5 °C)		
		15	+6 °F (+3.0 °C)		
		16	+7 °F (+3.5 °C)		
17	+8 °F (+4.0 °C)				

### 3) Room temperature control for wired remote controller sensor

**NOTE:** Before performing this setting, refer to Function 95.

Depending on the installed environment, correction of the wire remote temperature sensor may be required. Select the appropriate control setting according to the installed environment.

To change this setting, set Function 42 to Both "01".

Ensure that the Thermo Sensor icon is displayed on the remote controller screen.

Function number		Setting value	Setting description	Factory setting	
35 (For cooling)	36 (For heating)	00	Standard setting*	◆	
		01	No correction 0.0 °F (0.0 °C)		
		02	-1 °F (-0.5 °C)	More cooling Less heating	
		03	-2 °F (-1.0 °C)		
		04	-3 °F (-1.5 °C)		
		05	-4 °F (-2.0 °C)		
		06	-5 °F (-2.5 °C)		
		07	-6 °F (-3.0 °C)		
		08	-7 °F (-3.5 °C)		
		09	-8 °F (-4.0 °C)		
		10	+1 °F (+0.5 °C)	Less cooling More heating	
		11	+2 °F (+1.0 °C)		
		12	+3 °F (+1.5 °C)		
		13	+4 °F (+2.0 °C)		
		14	+5 °F (+2.5 °C)		
		15	+6 °F (+3.0 °C)		
		16	+7 °F (+3.5 °C)		
17	+8 °F (+4.0 °C)				

### 4) Auto restart

Enables or disables automatic restart after a power interruption.

Function number	Setting value	Setting description	Factory setting
40	00	Enable	◆
	01	Disable	

**NOTE:** Auto restart is an emergency function such as for power outage etc. Do not attempt to use this function in normal operation. Be sure to operate the unit by remote controller or external device.

### 5) Room temperature sensor switching

(Only for wired remote controller)

When using the wired remote controller temperature sensor, change the setting to "Both" (01).

Function number	Setting value	Setting description	Factory setting
42	00	Indoor unit	◆
	01	Both	

00: Sensor on the indoor unit is active.

01: Sensors on both indoor unit and wired remote controller are active.

**NOTE:** Remote controller sensor must be turned on by using the remote controller.

**6) Remote controller custom code**

(Only for wireless remote controller)

The indoor unit custom code can be changed. Select the appropriate custom code.

Function number	Setting value	Setting description	Factory setting
44	00	A	◆
	01	B	
	02	C	
	03	D	

**7) External input control**

"Operation/Stop" mode or "Forced stop" mode can be selected.

Function number	Setting value	Setting description	Factory setting
46	00	Operation/Stop mode 1	◆
	01	(Setting prohibited)	
	02	Forced stop mode	
	03	Operation/Stop mode 2	

**8) Room temperature sensor switching (Aux.)**

To use the temperature sensor on the wired remote controller only, change the setting to "Wired remote controller" (01).

This function will only work if the function setting 42 is set at "Both" (01).

When the setting value is set to "Both" (00), more suitable control of the room temperature is possible by setting function setting 30 and 31 too.

Function number	Setting value	Setting description	Factory setting
48	00	Both	◆
	01	Wired remote controller	

**9) Indoor unit fan control for energy saving for cooling**

Enables or disables the power-saving function by controlling the indoor unit fan rotation when the outdoor unit is stopped during cooling operation.

Function number	Setting value	Setting description	Factory setting
49	00	Disable	
	01	Enable	
	02	Remote controller	◆

00: When the outdoor unit is stopped, the indoor unit fan operates continuously following the setting on the remote controller.

01: When the outdoor unit is stopped, the indoor unit fan operates intermittently at a very low speed.

02: Enable or disable this function by remote controller setting.

**NOTES:**

- As the factory setting, this setting is initially invalidated.
- Set to "00" or "01" when connecting a remote controller that cannot set the Fan control for energy saving function or connecting a network converter.  
To confirm if the remote controller has this setting, refer to the operating manual of each remote controller.

**10) Heat insulation condition (building insulation)**

Heat insulation conditions differ according to the installed environment.

"Standard insulation" (00) allows system to rapidly respond to the cooling or heating load changes.

"High insulation" (01) is when the heat insulation structure of the building is high and does not require system to rapidly respond to cooling or heating load changes.

When "High insulation" (01) is selected:

- Overheating (overcooling) is prevented at the start-up.
- All room-temperature control settings (Function 30, 31, 35, and 36) will reset to "No correction 0.0 °F (0.0 °C)".

Function number	Setting value	Setting description	Factory setting
95	00	Standard insulation	◆
	01	High insulation	

**NOTE:** When changing Function 95, perform this setting before other room-temperature control settings (Function 30, 31, 35, and 36). If Function 95 is not set first, room-temperature control settings (Function 30, 31, 35, and 36) will be reset and you must re-do them again.

## 11-2. Custom code setting for wireless remote controller

To interconnect the air conditioner and the wireless remote controller, assignment of the custom code for the wireless remote controller is required.

**NOTE:** Air conditioner cannot receive a signal if the air conditioner has not been set for the custom code.

When 2 or more air conditioners are installed in a room, and the remote controller is operating an air conditioner other than the one you wish to set, change the custom code of the remote controller to operate only the air conditioner you wish to set. (4 selections possible.)

Confirm the setting of the remote controller custom code and the function setting. If these do not match, the remote controller cannot be used to operate for the air conditioner.

1. Press the START/STOP button until only the clock is displayed on the remote controller display.
2. Press the MODE button for at least 5 seconds to display the current custom code. (Initially set to  $\text{A}$ .)
3. Press the TEMP. ( $\wedge$ ) ( $\vee$ ) buttons to change the custom code between  $\text{A} \rightarrow \text{B} \rightarrow \text{C} \rightarrow \text{D}$ . Match the code on the display to the air conditioner custom code. (Initially set to  $\text{A}$ .)
4. Press the MODE button again to return to the clock display. The custom code will be changed.



### NOTES:

- If no button is pressed within 30 seconds after the custom code is displayed, the system returns to the original clock indicator. In this case, start again from step 1.
- The air conditioner custom code is set to  $\text{A}$  prior to shipment. To change the custom code, contact your retailer.
- If you do not know the assigned code for the air conditioner, try each of the custom code ( $\text{A} \rightarrow \text{B} \rightarrow \text{C} \rightarrow \text{D}$ ) until you find the code which operates the air conditioner.

## 11-3. Switching the temperature unit of remote controller







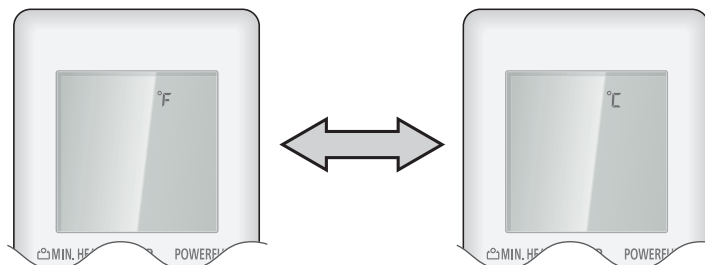



Displayed temperature unit on the remote controller LCD can be switched between °F (Fahrenheit) and °C (Celsius).

To change temperature unit, do as follows:

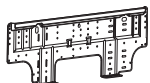
1. Press the TEMP. (Up) button (∧) for at least 5 seconds to display the current temperature unit. (Factory setting: °F)
2. Press the TEMP. (∧) (∨) buttons to switch the temperature unit between °F and °C.
3. With either of pressing the START/STOP button or no additional button operation for 30 seconds in step 2., the temperature unit currently selected will be set.

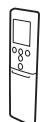
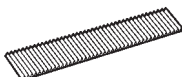

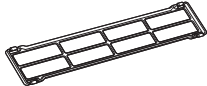

## 12. Accessories

Part name	Exterior	Q'ty	Part name	Exterior	Q'ty
Operating manual		1	Wireless LAN label (Attached to the indoor unit beside the wireless LAN indicator)		1
Setting manual (for Wireless LAN control)		1	Cloth tape		1
Installation manual		1	Tapping screw (large)		1
Wall hook bracket		1	Tapping screw (small)		5
Remote controller		1	Air cleaning filter		2
Battery		2	Filter holder		2
Remote controller holder		1	Seal A (for 15 model)		1

## 13. Optional parts

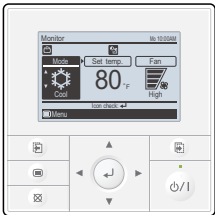
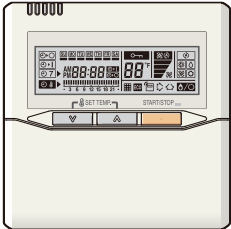

### 13-1. Controllers

Exterior	Part name	Model name	Summary
	Wired remote controller	UTY-RVNUM	Large and full-dot liquid crystal screen, wide and large keys easy to press, user-intuitive arrow key. Wire type: Polar 3-wire Optional communication kit is necessary for installation.
	Wired remote controller	UTY-RNNUM	Room temperature can be controlled by detecting the temperature accurately with built-in thermo sensor. Wire type: Polar 3-wire Optional communication kit is necessary for installation.
	Simple remote controller	UTY-RSNUM	Compact remote controller concentrates on the basic functions such as Start/Stop, fan control, temperature setting, and operation mode. Wire type: Polar 3-wire Optional communication kit is necessary for installation.

#### NOTES:

- Available functions may differ by the remote controller. For details, refer to the operation manual.
- In this product, group controlling system of the wired remote controller is prohibited.

### 13-2. Others

Exterior	Part name	Model name	Summary
	External connect kit	UTY-XWZXZ5	Required when external device is connected. Optional communication kit is necessary for installation.
	Communication kit	UTY-TWBXF1	Use to connect with optional devices and air conditioner PCB.



# **Part 2. OUTDOOR UNIT**

---

**SINGLE TYPE:**

**AOU9RLS3**

**AOU12RLS3**

**AOU15RLS3**

# 1. Specifications

Type				Inverter heat pump		
Model name				AOU9RLS3	AOU12RLS3	AOU15RLS3
Power supply				208/230 V ~ 60 Hz		
Available voltage range				188—253 V		
Starting current				3.3	4.7	5.2
Fan	Airflow rate	Cooling	CFM (m <sup>3</sup> /h)	989 (1,680)		1,206 (2,050)
		Heating		1,082 (1,840)		
	Type × Q'ty				Propeller fan × 1	
Motor output		W		49		
Sound pressure level *1	Cooling	dB (A)	42		43	49
	Heating		47			50
Heat exchanger type	Dimensions (H × W × D)	in	23-1/8 × 34-11/16 × 1-7/16			
		mm	588 × 881 × 36.4			
	Fin pitch	FPI	20			
	Rows × Stages				2 × 28	
	Pipe type				Copper	
	Fin type	Type (Material)	Corrugate (Aluminum)			
	Surface treatment	Corrosion resistance (Blue fin)				
Compressor	Type × Q'ty				Rotary × 1	
	Motor output	W	850		1,000	
Refrigerant	Type				R410A	
	Charge	lb oz	2 lb 14 oz		3 lb 1 oz	
		g	1,300		1,400	
Refrigerant oil	Type				FREOL (ø68SZ)	
	Amount	in <sup>3</sup> (cm <sup>3</sup> )				12.5 (205)
Enclosure	Material				Steel sheet	
	Color				Beige Approximate color of Munsell 10YR 7.5/1.0	
Dimensions (H × W × D)	Net	in	24-1/2 × 31-1/8 × 11-7/16			
		mm	620 × 790 × 290			
	Gross	in	28-1/16 × 37-3/16 × 15-9/16			
		mm	713 × 945 × 395			
Weight	Net	lb (kg)	84 (38)		86 (39)	
	Gross		93 (42)			
Connection pipe	Size	Liquid	in (mm)	Ø 1/4 (Ø 6.35)		
		Gas		Ø 3/8 (Ø 9.52)		
	Method		Flare			
	Pre-charge length		ft (m)	49 (15)		
	Max. length			66 (20)		
	Max. height difference			49 (15)		
Operation range	Cooling	°F (°C)	14 to 115 (-10 to 46)			
	Heating		-5 to 75 (-21 to 24)			
Drain hose	Material				LDPE	
	Size	in (mm)	Ø 9/16 (Ø 13.8) [I. D.] Ø 5/8 to Ø 11/16 (Ø 15.8 to Ø 16.7) [O. D.]			

**NOTES:**

- Specifications are based on the following conditions:
  - Cooling: Indoor temperature of 80 °FDB (26.67 °CDB) / 67 °FWB (19.44 °CWB), and outdoor temperature of 95 °FDB (35 °CDB) / 75 °FWB (23.9 °CWB).
  - Heating: Indoor temperature of 70 °FDB (21.11 °CDB) / 59 °FWB (15 °CWB), and outdoor temperature of 47 °FDB (8.33 °CDB) / 43 °FWB (6.11 °CWB).
  - Pipe length: 24.6 ft (7.5 m), Height difference: 0 ft (0 m). (Between outdoor unit and indoor unit.)
- Protective function might work when using it outside the operation range.
- \*1: Sound pressure level
  - Measured values in manufacturer's anechoic chamber.
  - Because of the surrounding sound environment, the sound levels measured in actual installation conditions might be higher than the specified values here.

## 2. Dimensions

### 2-1. Models: AOU9RLS3, AOU12RLS3, and AOU15RLS3

Unit: in (mm)

OUTDOOR UNIT  
AOU9-15RLS3

OUTDOOR UNIT  
AOU9-15RLS3

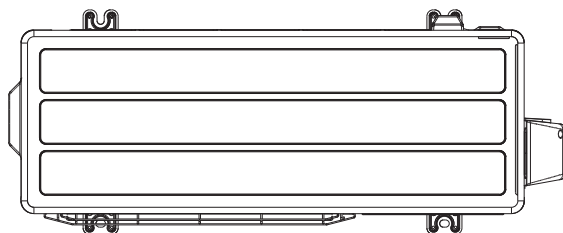

Top view

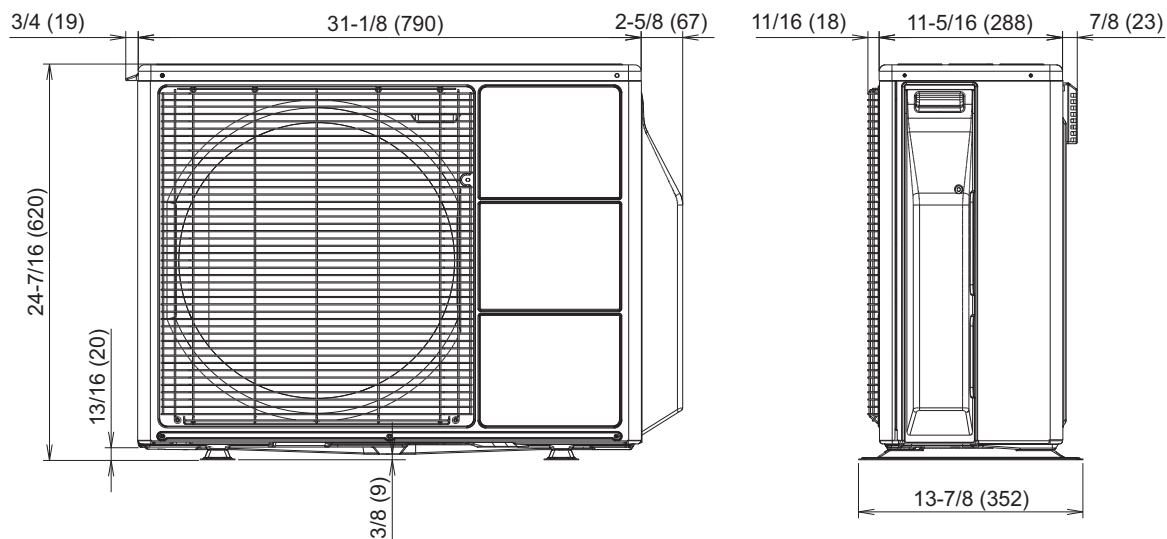

Front view

Side view

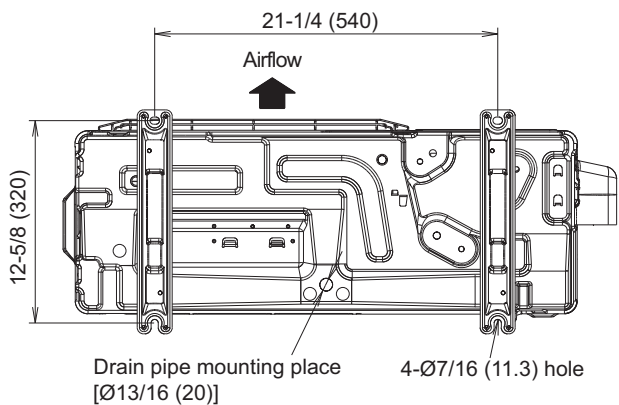

Bottom view

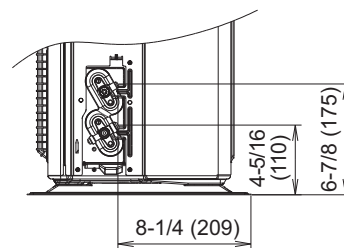

Drain pipe mounting place  
[Ø13/16 (20)]

4-Ø7/16 (11.3) hole

## 3. Installation space

### 3-1. Models: AOU9RLS3, AOU12RLS3, and AOU15RLS3

#### ■ Space requirement

Provide sufficient installation space for product safety.

#### ● Single outdoor unit installation

- When the upper space is open:

Unit: in (mm)

When there are obstacles at the rear only.

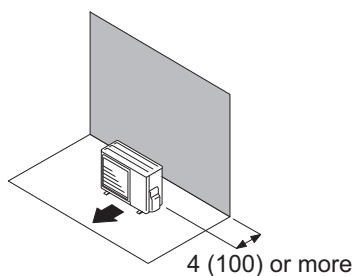

When there are obstacles at the rear and sides.

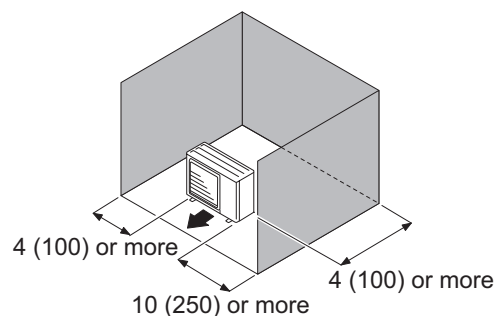

When there are obstacles at the front only.

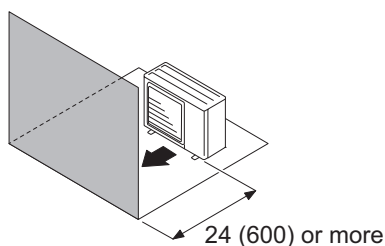

When there are obstacles at the front and rear.

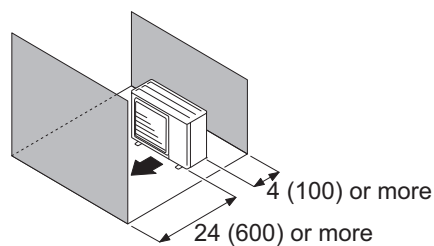

- When there is an obstruction in the upper space:

Unit: in (mm)

When there are obstacles at the rear and above.

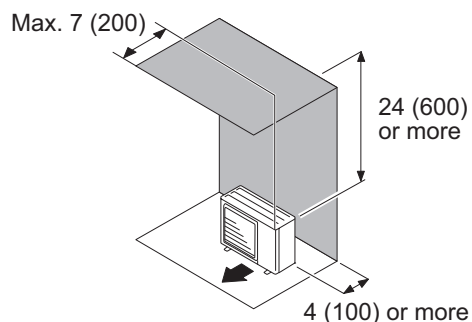

When there are obstacles at the rear, sides, and above.

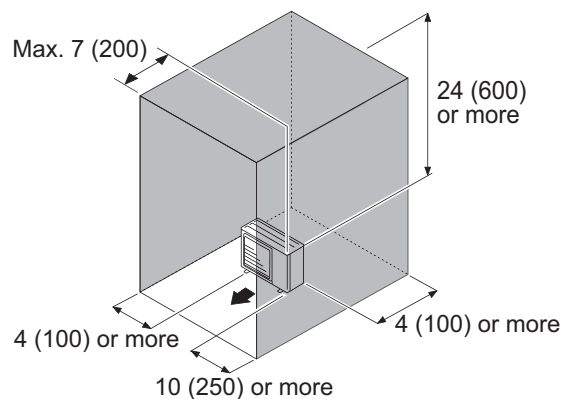

## ● Multiple outdoor unit installation

- When the upper space is open:

Unit: in (mm)

When there are obstacles at the rear only.

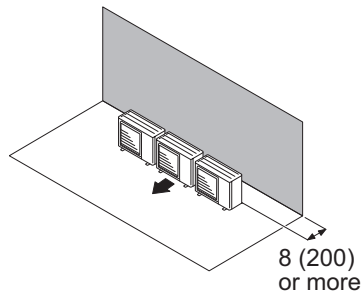

When there are obstacles at the front only.

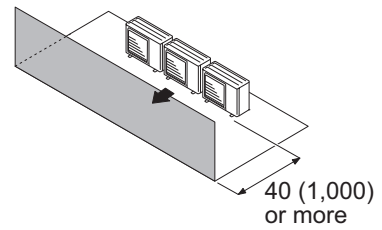

When there are obstacles at the front and rear.

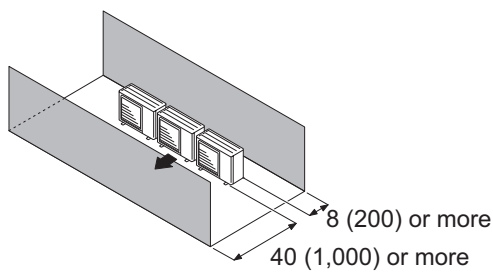

- When there is an obstruction in the upper space:

Unit: in (mm)

When there are obstacles at the rear and above.

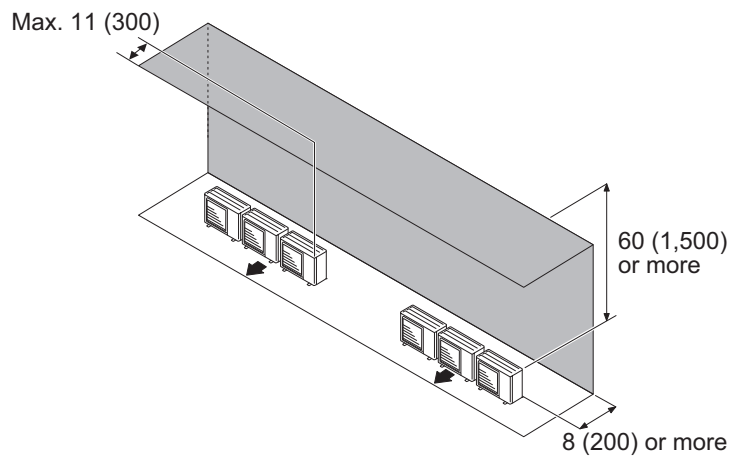

## ● Outdoor unit installation in multi-row

Unit: in (mm)

Single parallel unit arrangement

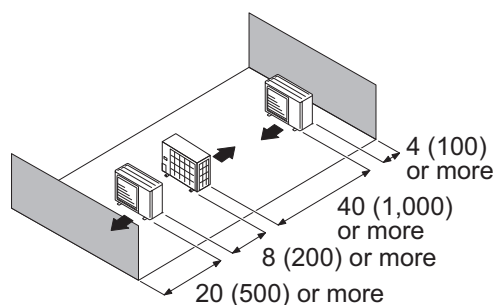

Multiple parallel unit arrangement

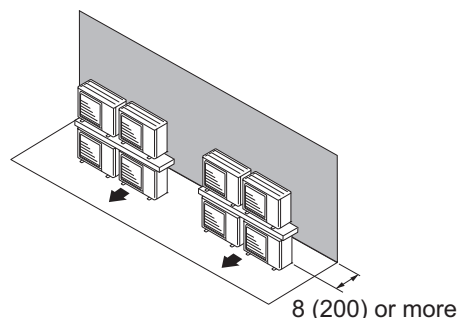
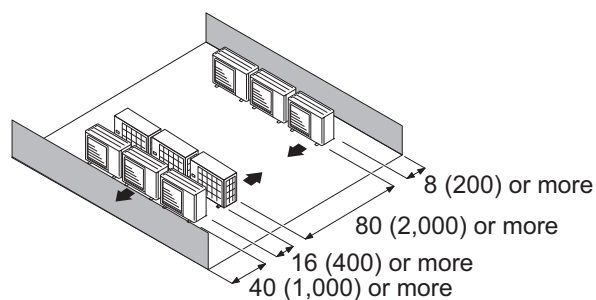

### NOTES:

- If the space is larger than stated above, the condition will be the same as when there is no obstacle.
- Height above the floor level should be 2 in (50 mm) or more.
- When installing the outdoor unit, be sure to open the front and left side to obtain better operation efficiency.

### ⚠ CAUTION

- Do not install the outdoor unit in two-stage where the drain water could freeze. Otherwise the drainage from the upper unit may form ice and cause a malfunction of the lower unit.
- When the outdoor temperature is 32 °F (0 °C) or less, do not use the accessory drain pipe and drain cap. If the drain pipe and drain cap are used, the drain water in the pipe may freeze in extremely cold climate. (For reverse cycle model only.)
- In area with heavy snowfall, if the inlet and outlet of the outdoor unit is blocked with snow, it might become difficult to get warm, and it is likely to cause product malfunction. Construct a canopy and a pedestal, or place the unit on a high stand that is locally installed.

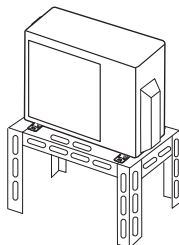

# 4. Refrigerant circuit

## 4-1. Models: AOU9RLS3 and AOU12RLS3

OUTDOOR UNIT  
AOU9-15RLS3

OUTDOOR UNIT  
AOU9-15RLS3

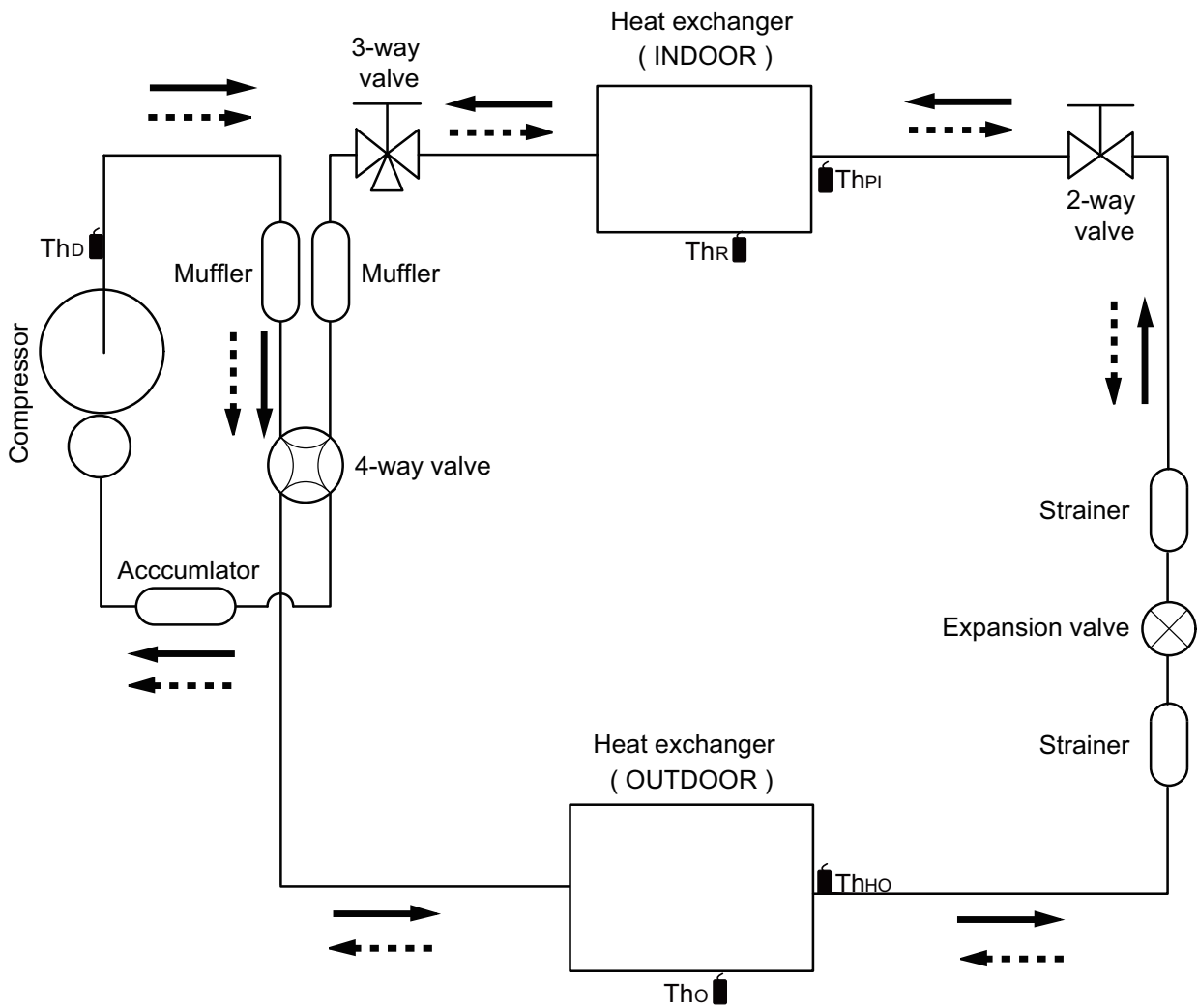

—————> Cooling  
 .....> Heating

- Th<sub>D</sub> : Thermistor (Discharge temp.)
- Th<sub>O</sub> : Thermistor (Outdoor temp.)
- Th<sub>HO</sub> : Thermistor (Heat exchanger out temp.)
- Th<sub>R</sub> : Thermistor (Room temp.)
- Th<sub>PI</sub> : Thermistor (Pipe temp.)

## 4-2. Model: AOU15RLS3

OUTDOOR UNIT  
AOU9-15RLS3

OUTDOOR UNIT  
AOU9-15RLS3

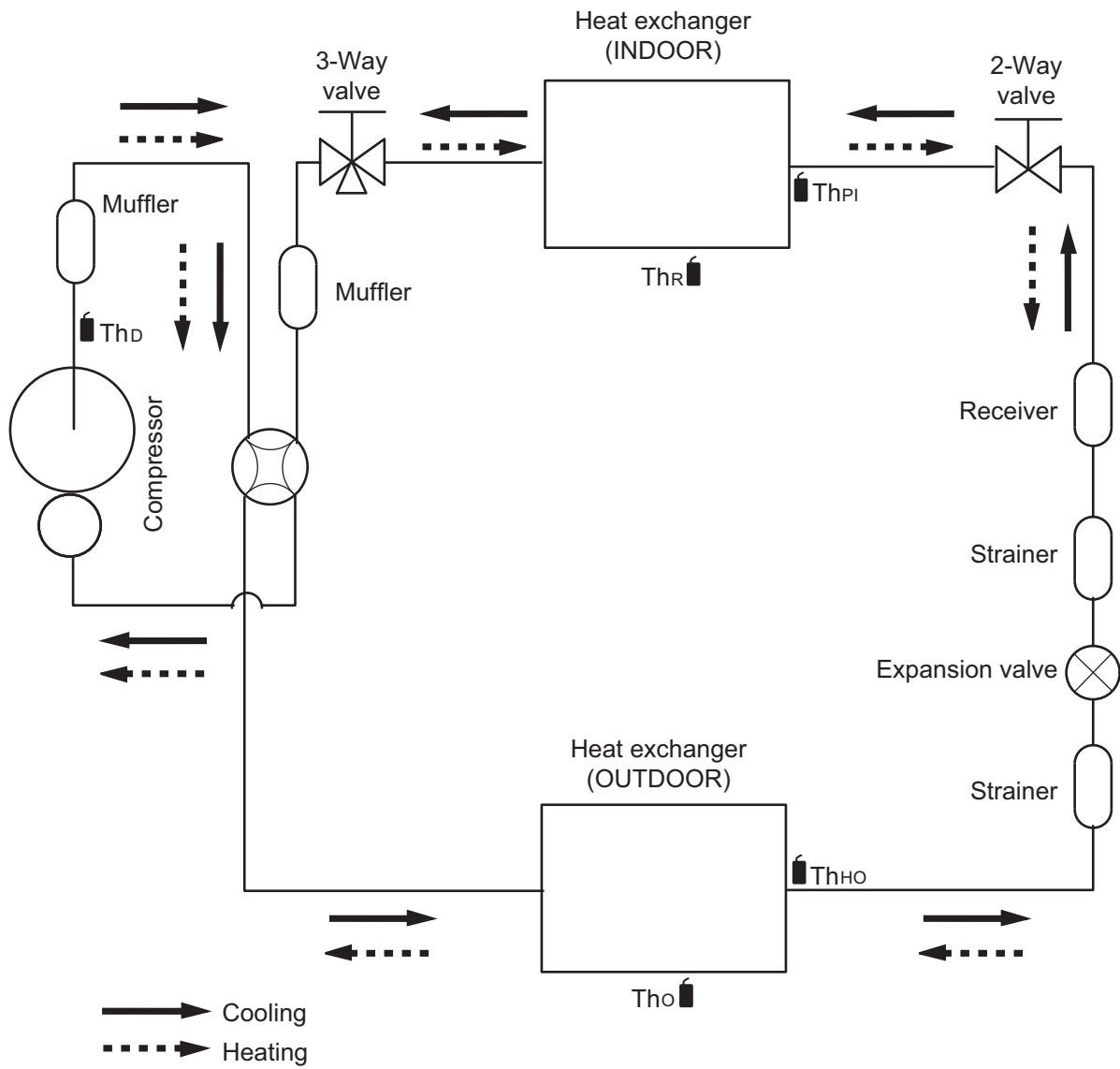

- Th<sub>D</sub> : Thermistor (Discharge temp.)
- Th<sub>O</sub> : Thermistor (Outdoor temp.)
- Th<sub>HO</sub> : Thermistor (Heat exchanger out temp.)
- Th<sub>R</sub> : Thermistor (Room temp.)
- Th<sub>PI</sub> : Thermistor (Pipe temp.)



# 5. Wiring diagrams

## 5-1. Models: AOU9RLS3 and AOU12RLS3

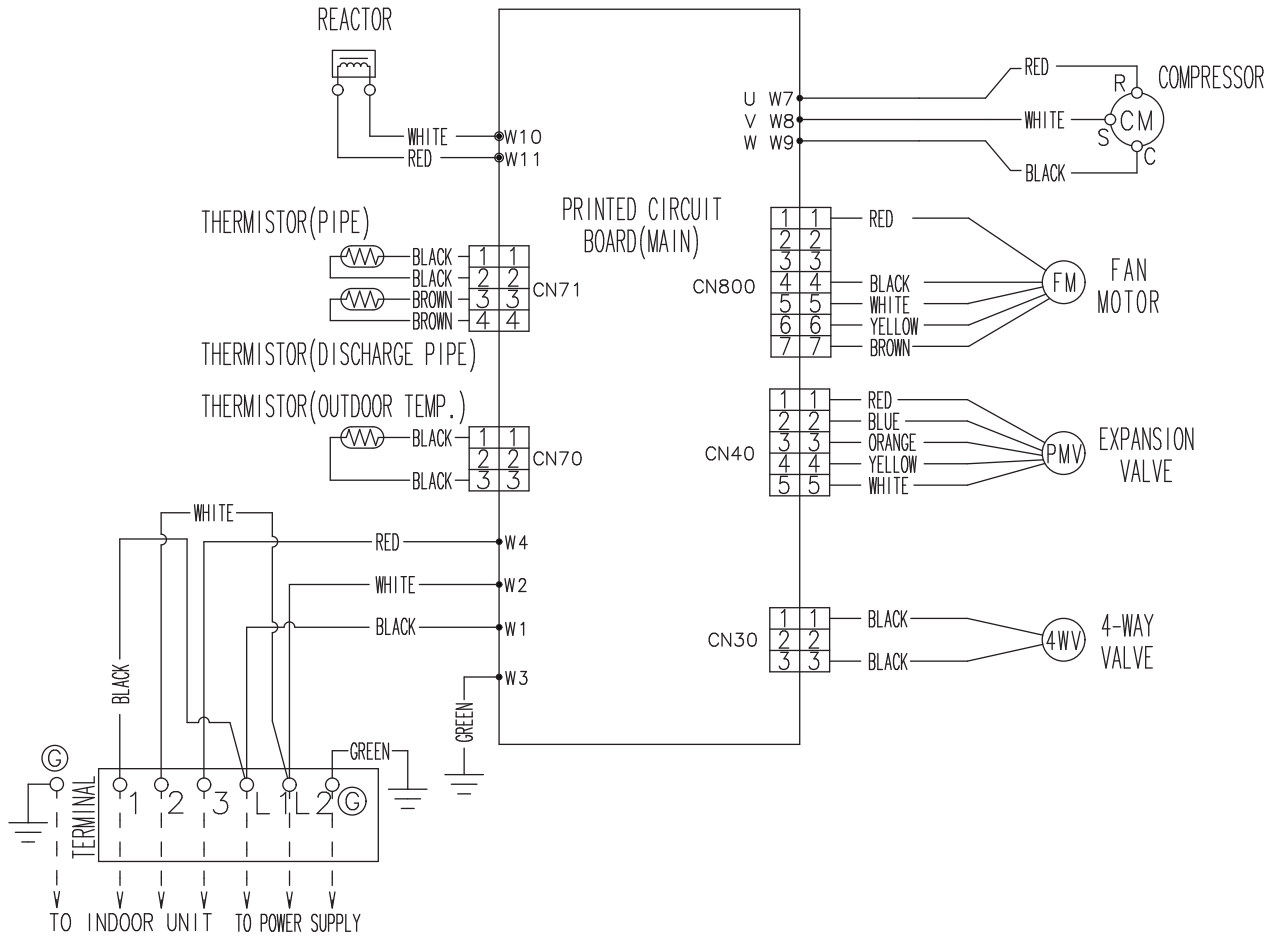

OUTDOOR UNIT  
AOU9-15RLS3

OUTDOOR UNIT  
AOU9-15RLS3

# 5-2. Model: AOU15RLS3

OUTDOOR UNIT  
AOU9-15RLS3

OUTDOOR UNIT  
AOU9-15RLS3

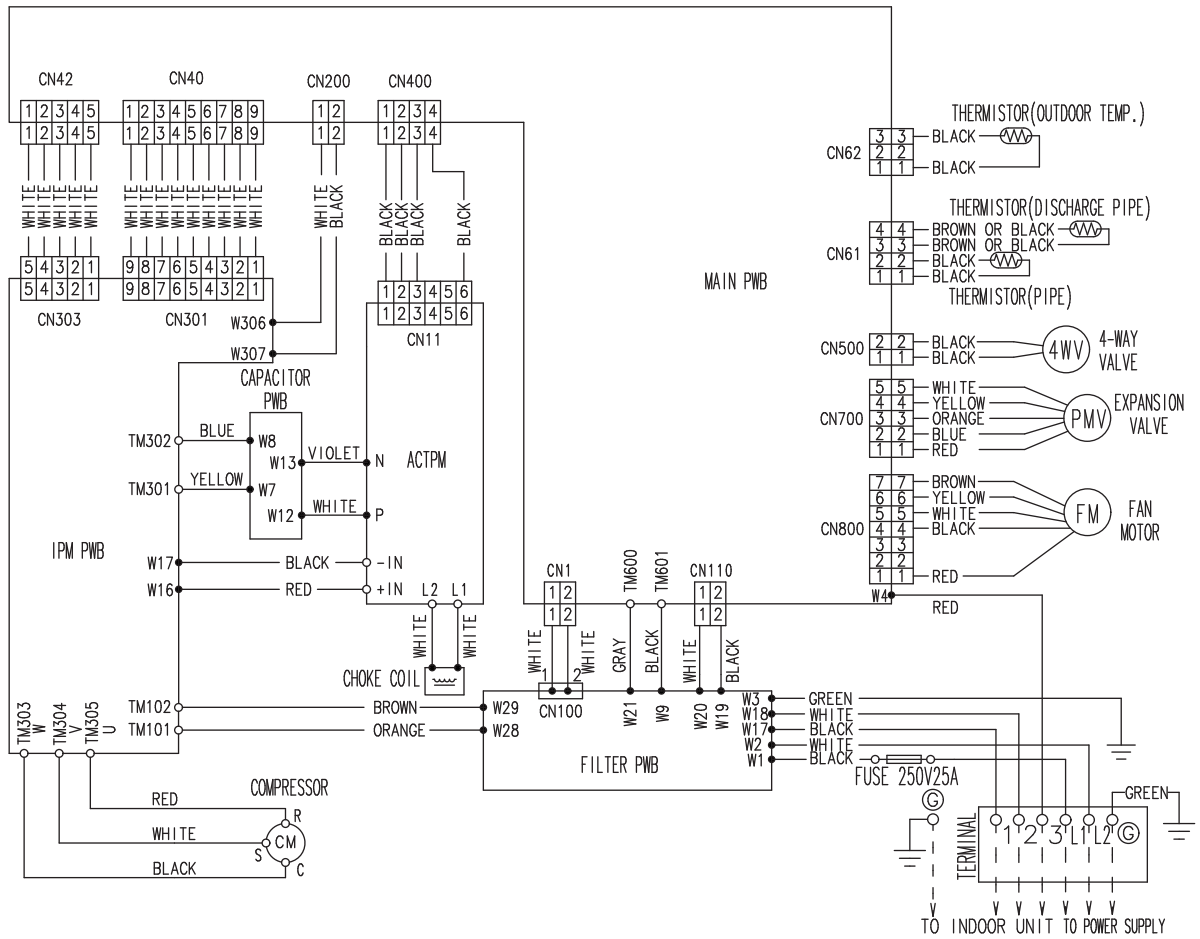

## 6. Capacity compensation rate for pipe length and height difference

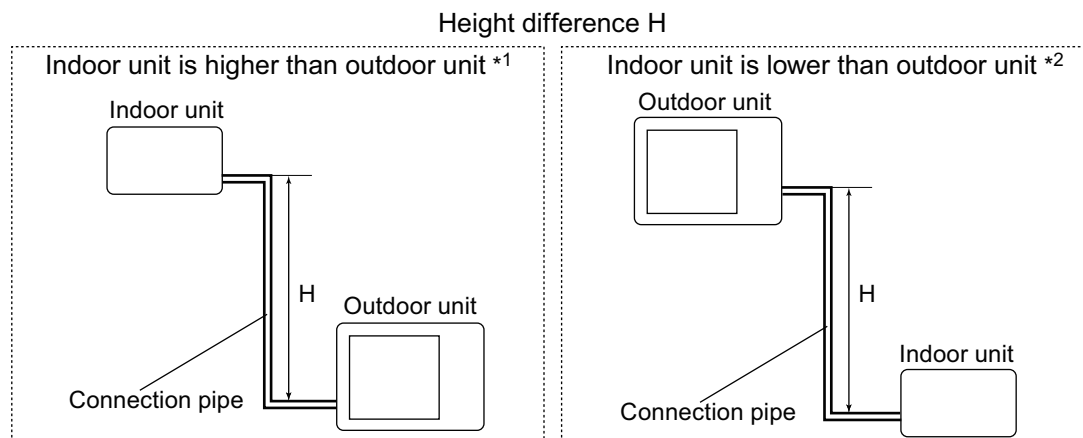

### 6-1. Models: AOU9RLS3 and AOU12RLS3

**NOTE:** Values mentioned in the table are calculated based on the maximum capacity.

COOLING		Pipe length						
		m						
			ft	5	7.5	10	15	20
Height difference H	Indoor unit is higher than outdoor unit *1	15	49	-	-	-	0.877	0.874
		10	32	-	-	0.956	0.891	0.888
		7.5	24	-	0.988	0.960	0.895	0.892
		5	16	1.017	0.992	0.964	0.899	0.895
	Indoor unit is lower than outdoor unit *2	0	0	1.025	1.000	0.971	0.906	0.902
		-5	-16	1.025	1.000	0.971	0.906	0.902
		-7.5	-24	-	1.000	0.971	0.906	0.902
		-10	-32	-	-	0.971	0.906	0.902
		-15	-49	-	-	-	0.906	0.902

HEATING		Pipe length						
		m						
			ft	5	7.5	10	15	20
Height difference H	Indoor unit is higher than outdoor unit *1	15	49	-	-	-	0.933	0.925
		10	32	-	-	0.981	0.933	0.925
		7.5	24	-	1.000	0.981	0.933	0.925
		5	16	1.017	1.000	0.981	0.933	0.925
	Indoor unit is lower than outdoor unit *2	0	0	1.017	1.000	0.981	0.933	0.925
		-5	-16	1.012	0.995	0.976	0.928	0.920
		-7.5	-24	-	0.993	0.974	0.926	0.918
		-10	-32	-	-	0.971	0.923	0.916
		-15	-49	-	-	-	0.914	0.906

## 6-2. Model: AOU15RLS3

**NOTE:** Values mentioned in the table are calculated based on the maximum capacity.

COOLING		Pipe length						
		m	ft	5	7.5	10	15	20
				16	24	32	49	65
Height difference H	Indoor unit is higher than outdoor unit *1	15	49	-	-	-	0.951	0.950
		10	32	-	-	0.979	0.967	0.966
		7.5	24	-	0.988	0.983	0.971	0.970
		5	16	0.994	0.992	0.987	0.975	0.974
	0	0	1.002	1.000	0.995	0.983	0.982	
Indoor unit is lower than outdoor unit *2	-5	-16	1.002	1.000	0.995	0.983	0.982	
	-7.5	-24	-	1.000	0.995	0.983	0.982	
	-10	-32	-	-	0.995	0.983	0.982	
	-15	-49	-	-	-	0.983	0.982	

HEATING		Pipe length						
		m	ft	5	7.5	10	15	20
				16	24	32	49	65
Height difference H	Indoor unit is higher than outdoor unit *1	15	49	-	-	-	0.994	0.979
		10	32	-	-	1.012	0.994	0.979
		7.5	24	-	1.000	1.012	0.994	0.979
		5	16	0.969	1.000	1.012	0.994	0.979
	0	0	0.969	1.000	1.012	0.994	0.979	
Indoor unit is lower than outdoor unit *2	-5	-16	0.964	0.995	1.007	0.989	0.974	
	-7.5	-24	-	0.993	1.004	0.986	0.972	
	-10	-32	-	-	1.002	0.984	0.969	
	-15	-49	-	-	-	0.974	0.959	

## 7. Additional charge calculation

### 7-1. Models: AOU9RLS3 and AOU12RLS3

Refrigerant type		R410A
Refrigerant amount	lb oz	2 lb 14 oz
	g	1,300

#### ■ Refrigerant charge

Total pipe length	ft	49 or less	66 (Max.)	0.22 oz/ft (20 g/m)
	m	15 or less	20 (Max.)	
Additional charge	oz	0	+3.5	
	g	0	+100	

### 7-2. Model: AOU15RLS3

Refrigerant type		R410A
Refrigerant amount	lb oz	3 lb 1 oz
	g	1,400

#### ■ Refrigerant charge

Total pipe length	ft	49 or less	66 (Max.)	0.22 oz/ft (20 g/m)
	m	15 or less	20 (Max.)	
Additional charge	oz	0	+3.5	
	g	0	+100	

## 8. Airflow

### 8-1. Models: AOU9RLS3 and AOU12RLS3

#### ● Cooling

m <sup>3</sup> /h	1,680
l/s	467
CFM	989

#### ● Heating

m <sup>3</sup> /h	1,840
l/s	510
CFM	1,082

### 8-2. Model: AOU15RLS3

#### ● Cooling

m <sup>3</sup> /h	2,050
l/s	569
CFM	1,206

#### ● Heating

m <sup>3</sup> /h	1,840
l/s	510
CFM	1,082

# 9. Operation noise (sound pressure)

## 9-1. Noise level curve

### Model: AOU9RLS3

#### Cooling

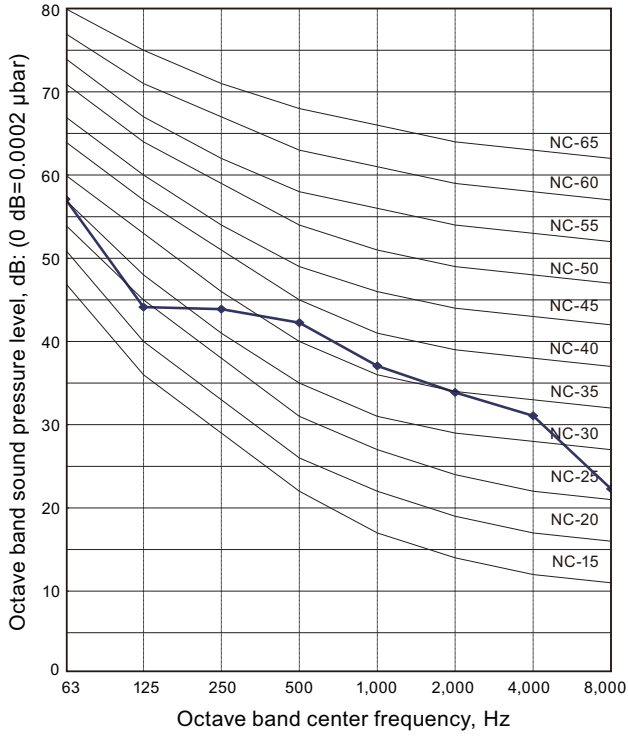

#### Heating

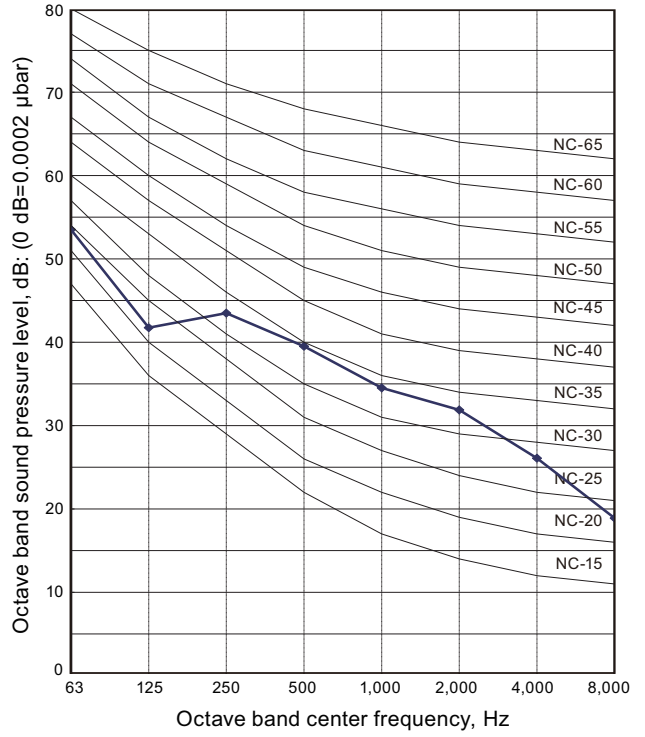

### Model: AOU12RLS3

#### Cooling

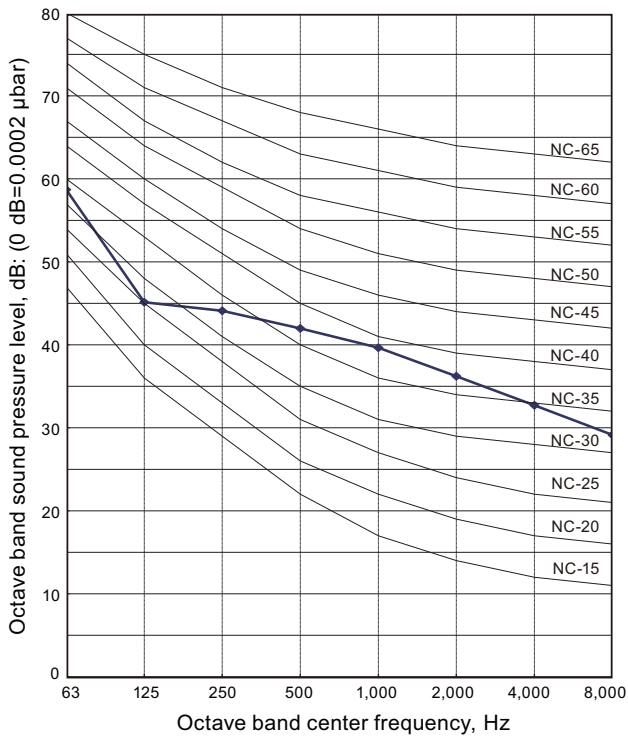

#### Heating

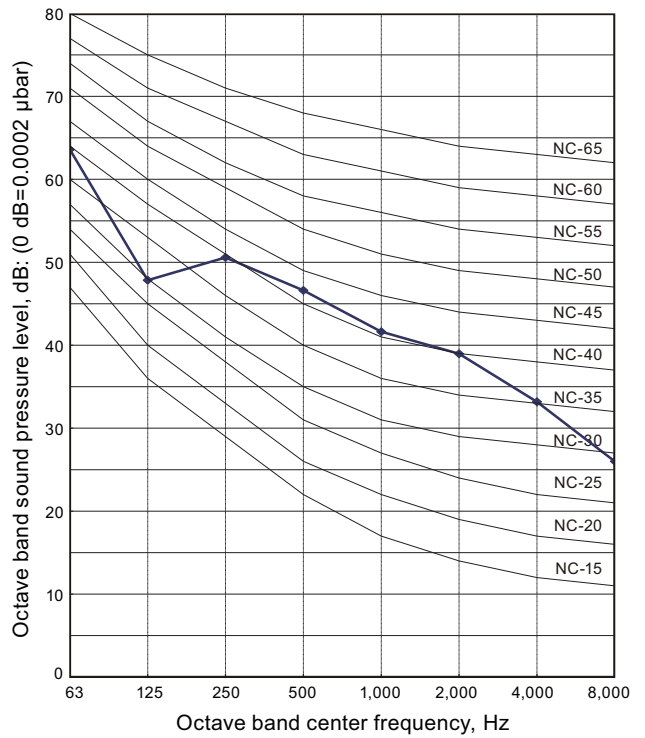

OUTDOOR UNIT  
AOU9-15RLS3

OUTDOOR UNIT  
AOU9-15RLS3

Model: AOU15RLS3

● Cooling

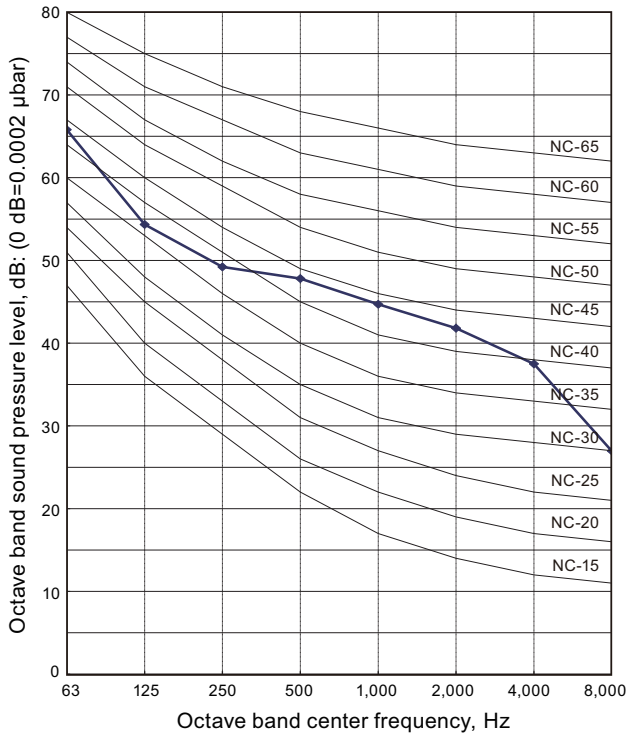

● Heating

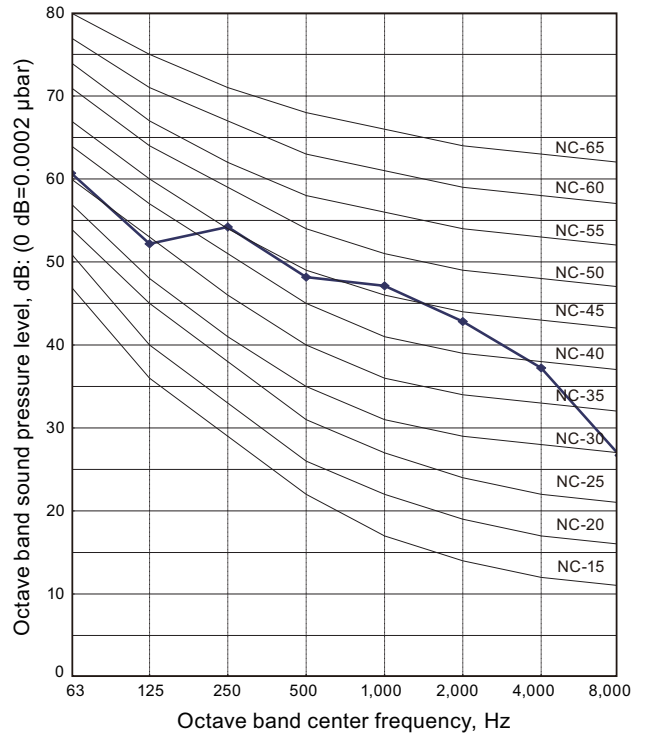

OUTDOOR UNIT  
AOU9-15RLS3

OUTDOOR UNIT  
AOU9-15RLS3

9-2. Sound level check point

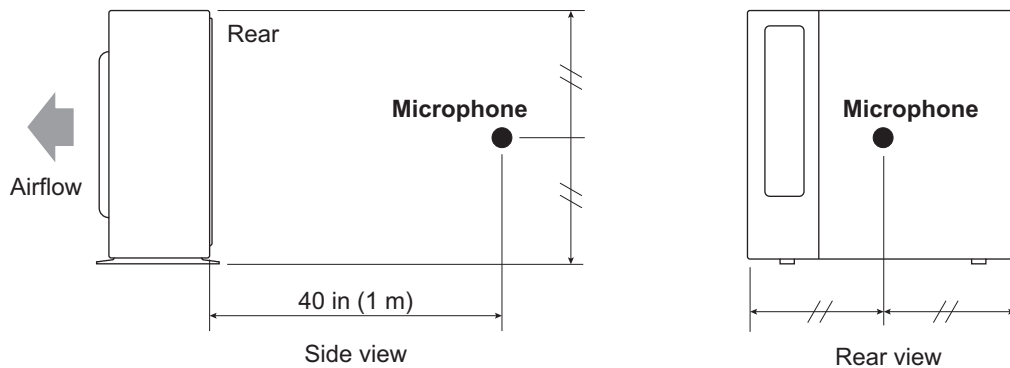

**NOTE:** Detailed shape of the actual outdoor unit might be slightly different from the one illustrated above.



## 10. Electrical characteristics

Model name			AOU9RLS3	AOU12RLS3	AOU15RLS3
Power supply	Voltage		V		
	Frequency		Hz		
MCA *1			13.4		17.2
Starting current			3.3	4.7	5.2
Wiring spec. *2	MAX. CKT. BKR *3		15		20
	Power cable		14		12
	Connection cable *4	Size	AWG		
		Limited wiring length	ft (m)		
			14		68 (21)

\*1: Minimum Circuit Ampacity (Calculation based on UL1995)

\*2: Selected sample based on Japan Electrotechnical Standards and Codes Committee E0005. As the regulations of wire size and circuit breaker differ in each country or region, select appropriate devices complied to the regional standard.



\*3: Maximum Circuit Breaker

\*4: Limit voltage drop to less than 2%. If voltage drop is 2% or more, increase cable conductor size.

## 11. Safety devices

Type of protection	Protection form		Model		
			AOU9RLS3	AOU12RLS3	AOU15RLS3
Circuit protection	Current fuse (Near the terminal)		250 V, 20 A		250 V, 25 A
			250 V, 5 A		
	Current fuse (Filter PCB)		—		250 V, 15 A
	Current fuse (Main PCB)		250 V, 15 A		250 V, 3.15 A
250 V, 3.15 A					
Fan motor protection	Thermal protection program	Activate	212±27 °F (110±15 °C) Fan motor stop		
		Reset	203±18 °F (95±10 °C) Fan motor restart		
Compressor protection	Thermal protection program (Discharge temp.)	Activate	230 °F (110 °C) Compressor stop		
		Reset	After 7 minutes Compressor restart		

## 12. Accessories

Part name	Exterior	Q'ty	Part name	Exterior	Q'ty
Installation manual		1	Drain cap		3
Drain pipe		1			