

**SPLIT TYPE
ROOM AIR CONDITIONER
WALL MOUNTED^{type}
INVERTER**

SERVICE INSTRUCTION

Models	Indoor unit	Outdoor unit
	ASU30RLE	AOU30RLXEH

Refrigerant
R410A

CONTENTS

1. DESCRIPTION OF EACH CONTROL OPERATION

1-1	COOLING OPERATION.....	01-01
1-2	HEATING OPERATION.....	01-02
1-3	DRY OPERATION.....	01-02
1-4	AUTO CHANGEOVER OPERATION.....	01-03
1-5	INDOOR FAN CONTROL.....	01-04
1-6	OUTDOOR FAN CONTROL.....	01-07
1-7	LOUVER CONTROL.....	01-08
1-8	COMPRESSOR CONTROL.....	01-09
1-9	TIMER OPERATION CONTROL.....	01-10
1-10	ELECTRONIC EXPANSION VALVE CONTROL.....	01-14
1-11	TEST OPERATION CONTROL.....	01-14
1-12	PREVENT TO RESTART FOR 3 MINUTES.....	01-15
1-13	4-WAY VALVE EXTENSION SELECT.....	01-15
1-14	AUTO RESTART.....	01-15
1-15	MANUAL AUTO OPERATION.....	01-15
1-16	COMPRESSOR PREHEATING.....	01-16
1-17	POWERFUL OPERATION.....	01-16
1-18	MINIMUM HEAT OPERATION.....	01-16
1-19	ECONOMY OPERATION.....	01-16
1-20	COMPRESSOR STOP OPERATION.....	01-17
1-21	LOW NOISE OPERATION.....	01-17
1-22	HUMAN SENSOR OPERATION.....	01-18
1-23	BASE HEATER OPERATION.....	01-18
1-24	PEAK CUT OPERATION.....	01-18
1-25	FORCED COOLING OPERATION.....	01-19
1-26	HEAT INSULATION CONDITION (When using the wireless RC).....	01-19
1-27	THERMO CONTROL (FOR INDOOR UNIT SENSOR).....	01-19
1-28	THERMO CONTROL (FOR WIRED REMOTE SENSOR).....	01-19
1-29	PUMP DOWN.....	01-20
1-30	DEFROST OPERATION CONTROL.....	01-21
1-31	OFF DEFROST OPERATION CONTROL.....	01-23
1-32	VARIOUS PROTECTIONS.....	01-24
1-33	DESCRIPTION OF DISPLAY UNIT.....	01-27
1-33-1	LAYOUT OF DISPLAY UNIT.....	01-27
1-33-2	DISPLAY MODE.....	01-28
1-33-3	ERROR HISTORY MODE.....	01-29

2. TROUBLE SHOOTING

2-1	ERROR DISPLAY	02-01
2-1-1	INDOOR UNIT AND WIRED REMOTE CONTROLLER DISPLAY.....	02-01
2-1-2	WIRED REMOTE CONTROLLER DISPLAY.....	02-02
2-1-3	OUTDOOR UNIT DISPLAY.....	02-03
2-2	TROUBLE SHOOTING WITH ERROR CODE.....	02-04
2-3	TROUBLE SHOOTING WITH NO ERROR CODE	02-37
2-4	SERVICE PARTS INFORMATION.....	02-46

3. APPENDING DATA

3-1	FUNCTION SETTING.....	03-01
3-2	THERMISTOR RESISTANCE VALUES.....	03-09
3-3	EXTERNAL INPUT AND OUTPUT.....	03-10

WALL MOUNTED type INVERTER

1 . DESCRIPTION OF EACH CONTROL OPERATION

1-1 COOLING OPERATION

A sensor (room temperature thermistor) built in the indoor unit will usually perceive difference or variation between a set temperature and present room temperature, and controls the operation frequency of the compressor.

- If the room temperature is 7.0°F(3.5°C) higher than a set temperature, the compressor operation frequency will attain to maximum frequency.
- If the room temperature is 1.0°F(0.5°C) lower than a set temperature, the compressor will be stopped.
- When the room temperature is between +7.0°F(3.5°C) to -1.0°F(0.5°C) of the setting temperature, the compressor frequency is controlled within the range shown in Table1. However, the maximum frequency is limited in the range shown in Fig.1 based on the fan speed mode and the outdoor temperature.

(Table 1 : Compressor frequency range)

	Minimum frequency	Maximum frequency
AOU30RLXEH	17 rps	46 rps

(Fig 1 : Limit of maximum frequency based on outdoor temperature)

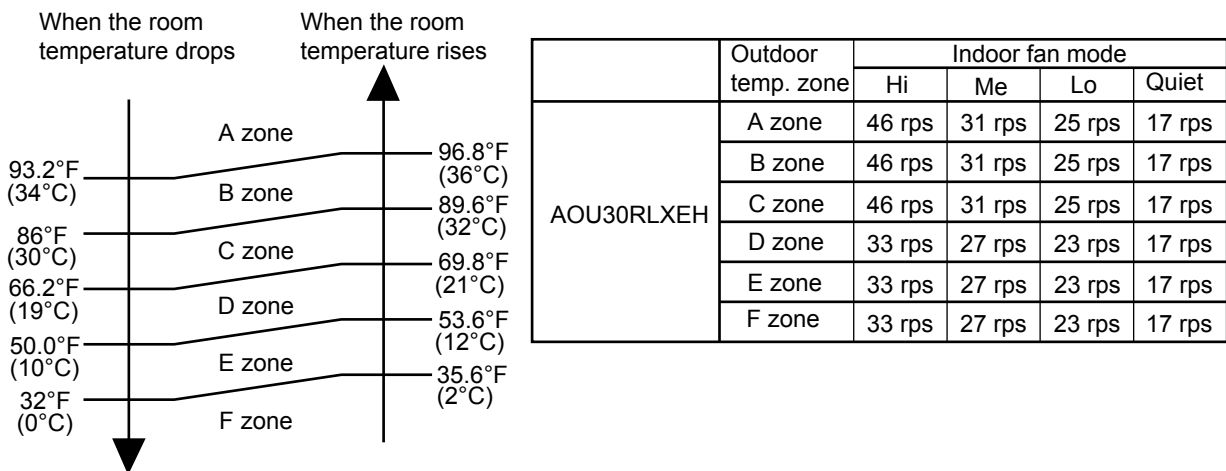

1-2. HEATING OPERATION

A sensor (room temperature thermistor) built in the indoor unit will usually perceive difference or variation between a set temperature and present room temperature, and controls the operation frequency of the compressor.

- If the room temperature is lower 9°F(4.5°C) than a set temperature, the compressor operation frequency will attain to maximum frequency.
- If the room temperature is higher 1°F(0.5°C) than a set temperature, the compressor will be stopped.
- When the room temperature is between +1°F(0.5°C) to -9°F(4.5°C) of the setting temperature, the compressor frequency is controlled within the range shown in Table 2.

(Table 2 : Compressor frequency range)

	Minimum frequency	Maximum frequency
AOU30RLXEH	18 rps	45 rps

1-3. DRY OPERATION

The compressor rotation frequency shall change according to set temperature and room temperature variation which the room temperature sensor of the indoor unit has detected as shown in the Table 3.

(Table 3 : Compressor frequency range)

		Frequency
AOU30RLXEH	J zone	17 rps
	X zone	15 rps
	Y zone	0 rps

(Fig.2 : Compressor control based on room temperature)

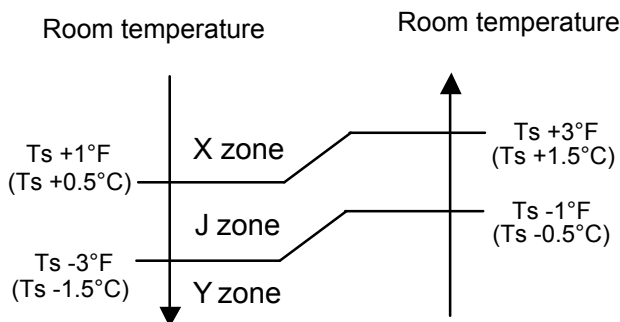

T_s : Setting temperature

1-4. AUTO CHANGEOVER OPERATION

When the air conditioner is set to the Auto mode by remote controller, operation starts in the optimum mode from among the Heating, Cooling, Dry and Monitoring mode.
 During operation, the optimum mode is automatically switched in accordance with temperature changes.
 The temperature can be set between 64°F (18°C) and 86°F (30°C) in 2°F (1°C) steps.

■ AUTO CHANGEOVER operation flow chart

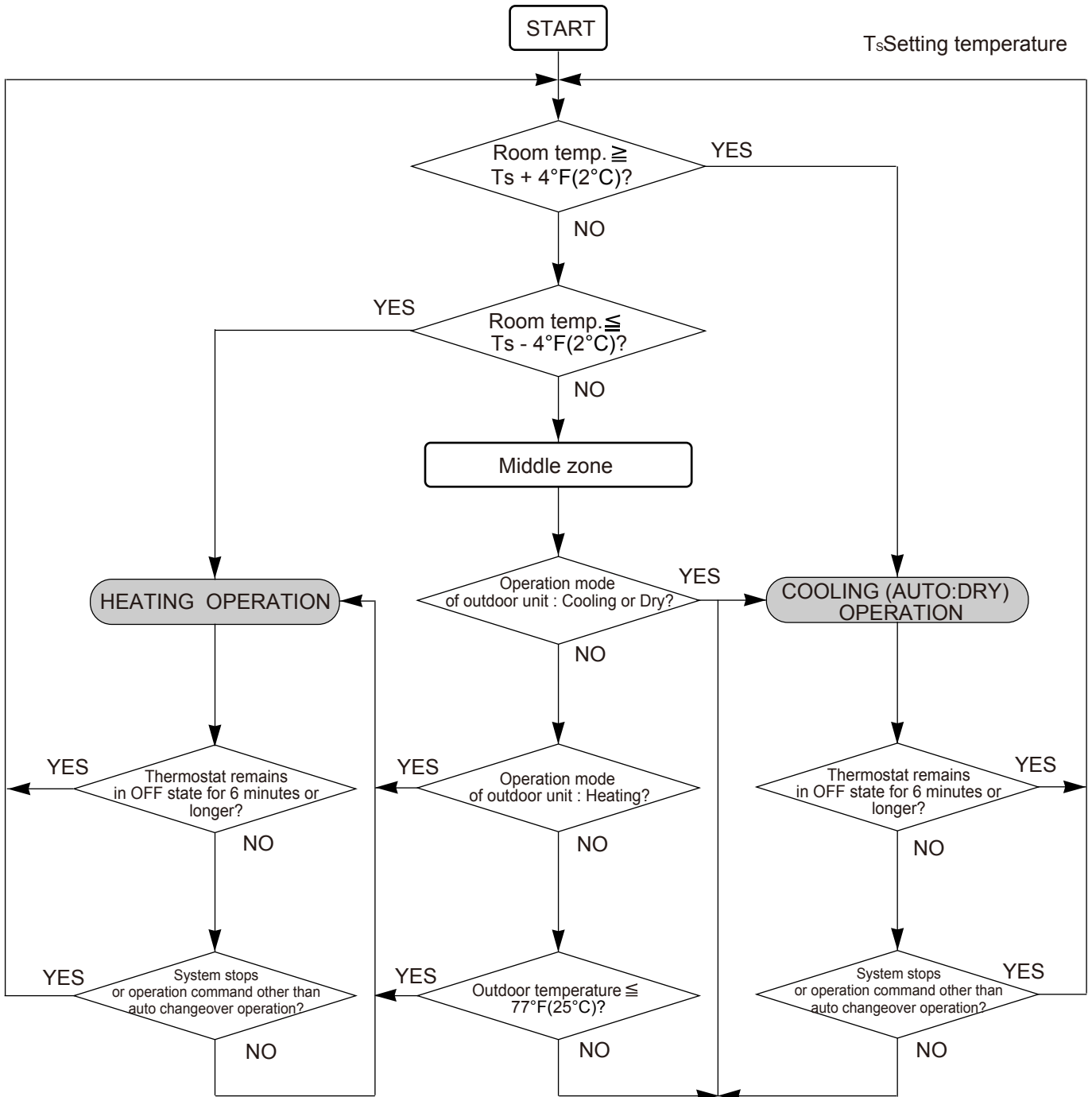

1-5. INDOOR FAN CONTROL

1. Fan speed

(Table 5 : Indoor fan speed)

Operation mode	Air flow mode	Speed (rpm)
Heating	Powerful	1520
	Hi	1370
	Me+	1260
	Me	1150
	Lo	950
	Quiet	780
	Cool air prevention	600
	S-Lo	540
Cooling /	Powerful	1520
	Hi	1370
	Me	1150
	Lo	950
	Quiet	780
Dry		X : 780 J : 680

2. FAN OPERATION

The airflow can be switched in 5 steps such as Auto, Quiet, Low, Med, High, while the indoor fan only runs.

3. COOLING OPERATION

Switch the airflow [Auto], and the indoor fan motor will run according to a room temperature, as shown in Fig.7.

On the other hand, if switched in [High]~[Quiet], the indoor motor will run at a constant airflow of [Cool] operation modes Quiet, Low, Med, High, as shown in Table 5.

(Fig.5 : Airflow change - over (Cooling : Auto))

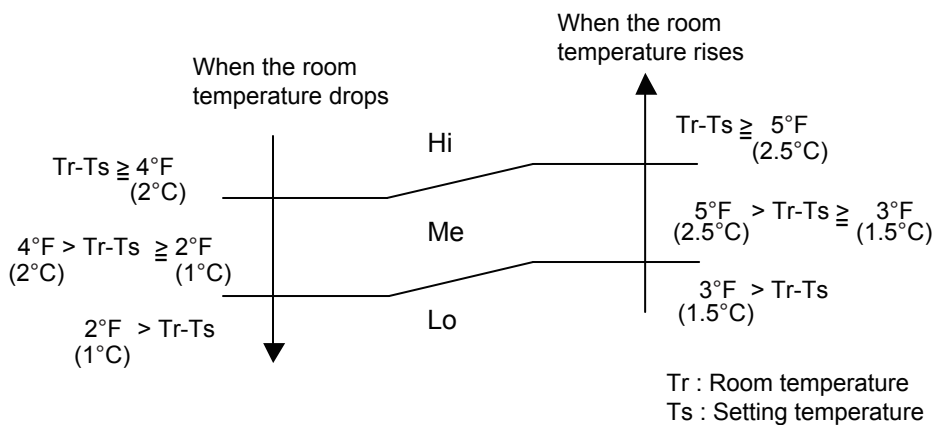

4. DRY OPERATION

The airflow can be switched in 5 steps such as Auto, Quiet, Low, Med, High, while the indoor fan only runs.

4. HEATING OPERATION

Switch the airflow [AUTO], and the indoor fan motor will run according to a room temperature, as shown in Fig.6.

On the other hand, if switched in [High] ~ [Quiet], the indoor motor will run at a constant airflow of [Heat] operation modes Quiet, Low, Med, High, as shown in Table 5.

(Fig.6 : Airflow change - over (Heating : Auto))

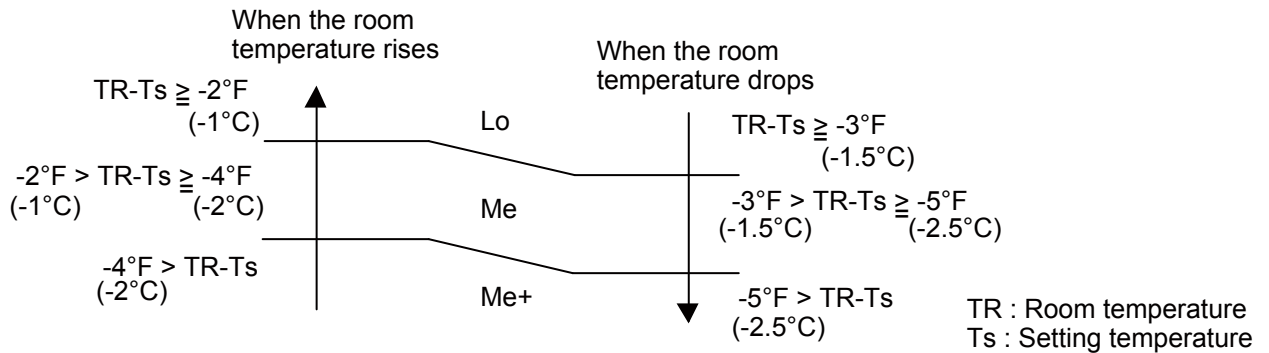

5. COOL AIR PREVENTION CONTROL

The maximum value of the indoor fan speed is set as shown in Fig.7, based on the detected temperature by the indoor heat exchanger sensor on heating mode.

When the compressor does not operate, the indoor fan motor operates [S-Lo] or [Stop] mode.

(Fig.7 : Cool air prevention control)

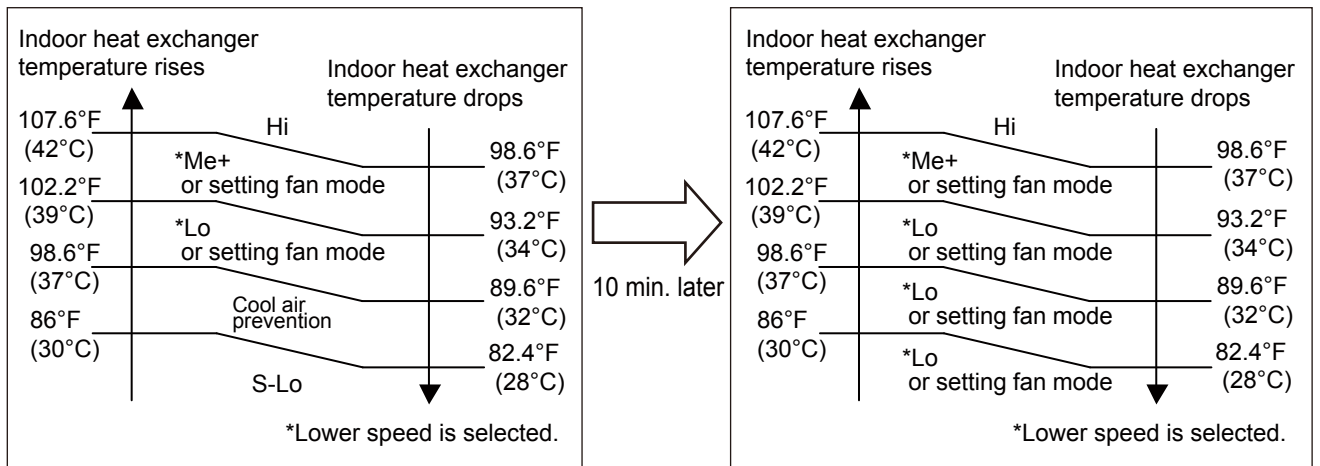

6. DEFROST OPERATION

When the defrost operation starts, the indoor fan runs according to cool air prevention control for 20 seconds. And the fan is stopped if 20 seconds have passed.

When 60 seconds have passed after defrost operation is released, the fan runs according to cool air prevention control.

8. MOISTURE RETURN PREVENTION CONTROL (Cooling mode& Dry mode)

Switch the airflow [AUTO] at cooling mode, addition, in the case of Energy saving setting "ON" and the indoor fan motor will run as shown in Fig. 8.

(Fig. 8 : Indoor Fan Control)

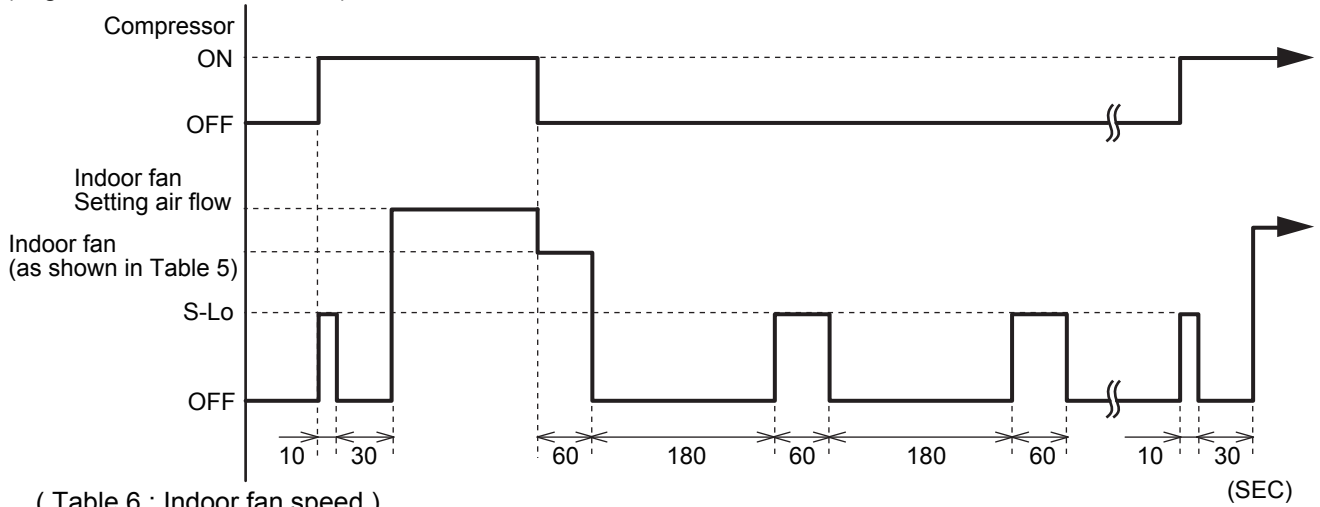

(Table 6 : Indoor fan speed)

	Dry			Cooling
	X zone	J zone	Y zone	
ASU30RLE	780rpm	680rpm	540rpm	780rpm

9. FAN CONTROL FOR ENERGY SAVING

When the air flow setting except AUTO mode, the indoor fan motor will run as shown in Fig. 9.

(Fig.9 : Indoor fan control)

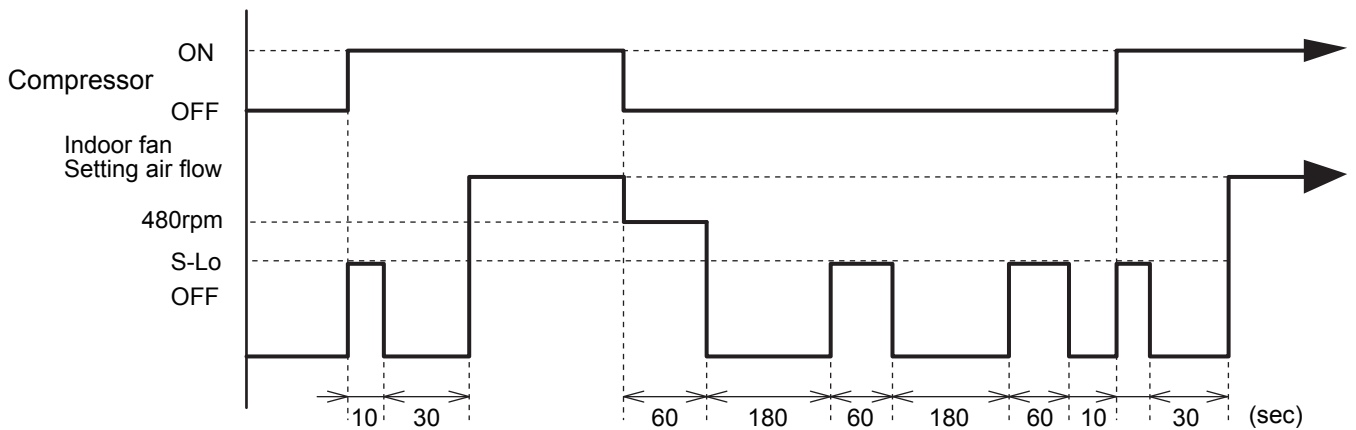

(◆ . . Factory setting)

Setting Description	Function Number	Setting Value
Disable	49	00
Enable		01
Remote controller		02

00 : When the outdoor unit is stopped, the indoor unit fan operates continuously following the setting on the remote controller.

01 : When the outdoor unit is stopped, the indoor unit fan operates intermittently at a very low speed.

02 : Enable or disable this function by remote controller setting.

Set to "00" or "01" when connecting a remote controller that cannot set the Fan control for energy saving function or connecting a network converter.

To confirm if the remote controller has this setting, refer to the operating manual of each remote controller.

1-6. OUTDOOR FAN CONTROL

1. Fan Speed

Following table shows the fan speed of the outdoor unit.

(Table 7 : Fan speed of the outdoor unit)

Cooling

AOU30RLXEH	Upper fan	850/ 780/ 520/ 480/ 400/ 350/ 280 rpm
	Lower fan	800/ 750/ 520/ 350/ 280/ 0 rpm

Heating

AOU30RLXEH	Upper fan	870/ 780/ 520/ 350/ 200/ 170/ 150 rpm
	Lower fan	840/ 750/ 520/ 350/ 200/ 170/ 150 rpm

- The outdoor fan speed is decided depending on the compressor and the outdoor temperature.
- The compressor and the fan start-up at the same time, and the fan stops after the compressor stops and 60 seconds has passed.

1-7. LOUVER CONTROL

1. VERTICAL LOUVER CONTROL

(Function Range)

Each time the button is pressed, the air direction range will change as follow:

① ⇄ ② ⇄ ③ ⇄ ④ ⇄ ⑤ ⇄ ⑥

The Remote Controller's display does not change.

(Fig. 10 : Vertical air direction range)

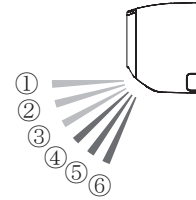

- Use the air direction adjustments within the ranges shown above.
- The vertical airflow direction is set automatically as shown, in accordance with the type of operation selected.

During Cooling / Dry mode : Horizontal flow ①

During Heating mode : Downward flow ⑤

- During AUTO mode operation, for the first a few minutes after beginning operation, airflow will be horizontal ① ; the air direction cannot be adjusted during this period.

The airflow direction setting will temporarily become ① when the temperature of the airflow is low at the start of the Heating mode.

- After beginning of AUTO/HEAT mode operated and automatic defrosting operation time, the air flow will be horizontal ①. However, the Airflow Direction cannot be adjusted at beginning AUTO operation mode.

2. HORIZONTAL LOUVER CONTROL

(Function Range)

Each time the button is pressed, the air direction range will change as follows.

⑤ ⇄ ④ ⇄ ① ⇄ ② ⇄ ③

(Fig. 11 : Horizontal air direction range)

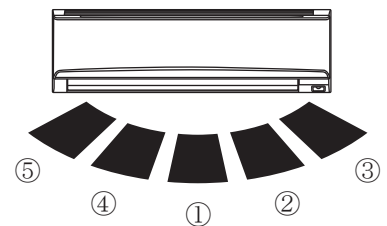

3. SWING OPERATION

To select Vertical Airflow Swing Operation

When the swing signal is received from the remote controller, the vertical louver starts to swing.

(Table 8 : Swinging range)

	Range
Cooling / Dry mode Fan mode (① ~ ③)	① ⇄ ④
Heating mode Fan mode (④ ~ ⑥)	③ ⇄ ⑥

- When the indoor fan is S-Lo or Stop mode, the swing operation is interrupted and it stops at either upper end or bottom end.

To select Horizontal Airflow Swing Operation

When the swing signal is received from the remote controller, the horizontal louver starts to swing.

(Table 9 : Swinging range)

	Range
All mode	① ⇄ ⑤

- When the indoor fan is S-Lo or Stop mode, the swing operation is interrupted and it stops at either upper end or bottom end.

To select Vertical and Horizontal Airflow Swing Operation

- When the horizontal swing signal is input from remote control, the combination of the vertical and horizontal swing operation is performed.

1-8. COMPRESSOR CONTROL

1. OPERATION FREQUENCY RANGE

The operation frequency of the compressor is different based on the operation mode as shown in Table 10.

(Table 10 : Compressor operation frequency range)

	Cooling		Heating	
	Min	Max	Min	Max
AOU30RLXEH	15rps	55rps	18rps	80rps

2. OPERATION FREQUENCY CONTROL AT START UP

The compressor frequency soon after the start-up is controlled as shown in Fig.12.

(Fig.12 : Compressor Control at Start-up)

< Normal start-up >

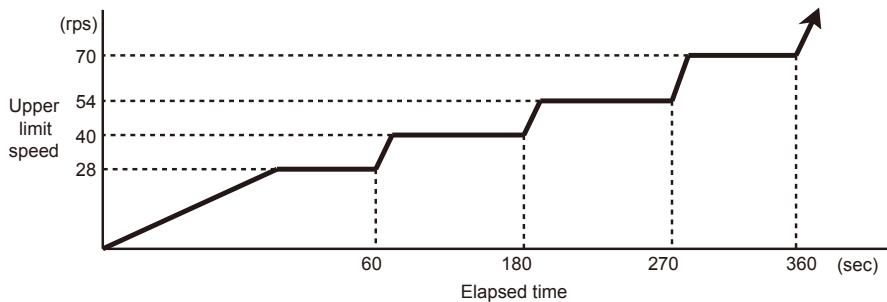

Condition
Mode: Cooling Below 3 hours from comp stop
Mode: Heating Below 3 hours from comp stop $T_a \geq 50^\circ\text{F}(10^\circ\text{C}), T_c \geq 89.6^\circ\text{F}(32^\circ\text{C})$

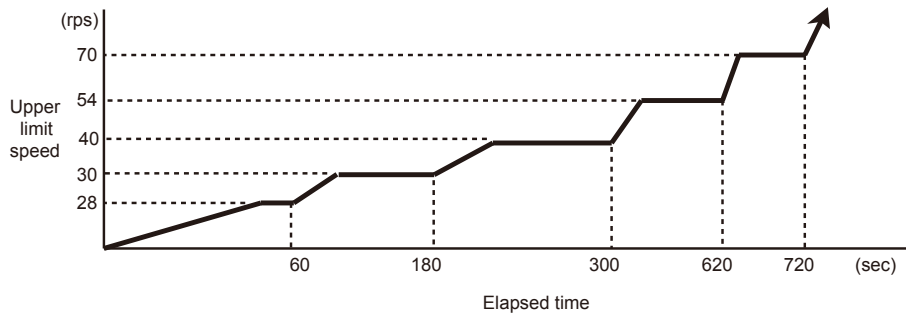

Condition
Mode: Cooling 3 hours or longer from comp stop $T_c > 89.6^\circ\text{F}(32^\circ\text{C})$

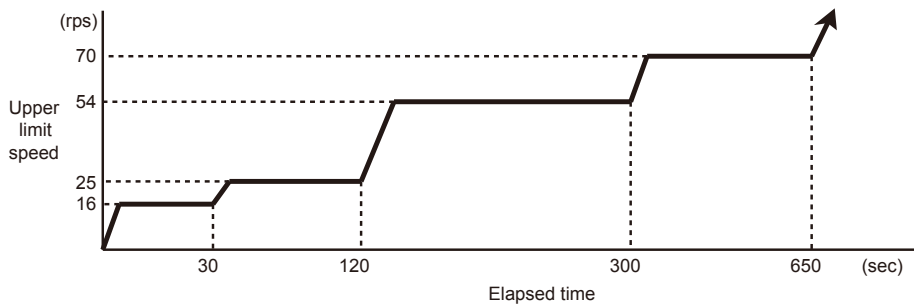

Condition
Mode: Heating 3 hours or longer from comp stop $T_a < 50^\circ\text{F}(10^\circ\text{C})$

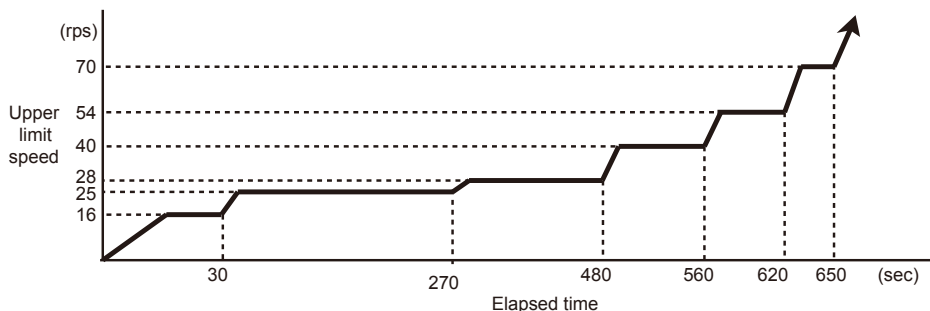

Condition
Mode: Heating 3 hours or longer from comp stop $T_a \geq 50^\circ\text{F}(10^\circ\text{C})$

T_a : Outdoor temperature
 T_c : Compressor temperature

1-9. TIMER OPERATION CONTROL

1-9-1 Wireless Remote Controller

The Table 11 show the available timer setting based on the product model.

(Table 11 : Timer setting)

	ON / OFF TIMER	PROGRAM TIMER	SLEEP TIMER	WEEKLY TIMER
ASU30RLE	○	○	○	○

1. ON / OFF TIMER

- OFF timer : When the clock reaches the set time, the air conditioner will be turned off.

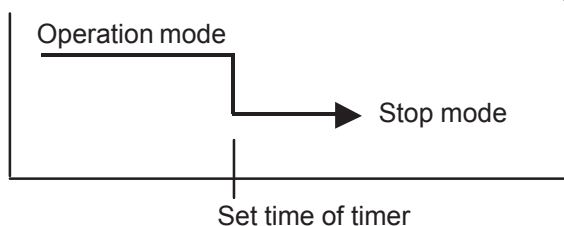

- ON timer : When the clock reaches the set time, the air conditioner will be turned on.

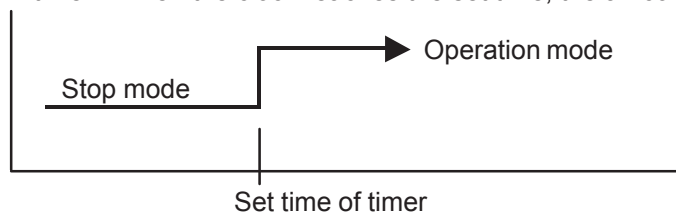

2. PROGRAM TIMER

- The program timer allows the OFF timer and ON timer to be used in combination one time.

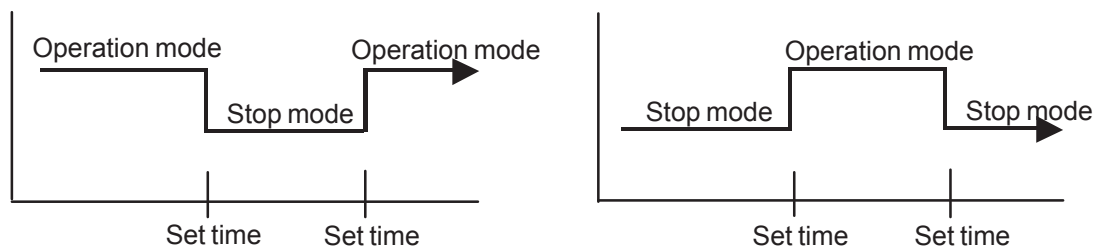

- Operation will start from the timer setting (either OFF timer or ON timer) whichever is closest to the clock's current timer setting.
The order of operations is indicated by the arrow in the remote control unit's display.
- SLEEP timer operation cannot be combined with ON timer operation.

3. SLEEP TIMER

- If the sleep timer is set, the room temperature is monitored and the operation is stopped automatically. If the operation mode or the set temperature is change after the sleep timer is set, the operation is continued according to the changed setting of the sleep timer from that time ON.

In the COOLING operation mode

When the sleep timer is set, the setting temperature is increased 2°F (1°C) . It increases the setting temperature another 2°F (1°C) after 1 hour. After that, the setting temperature is not changed and the operation is stopped at the time of timer setting.

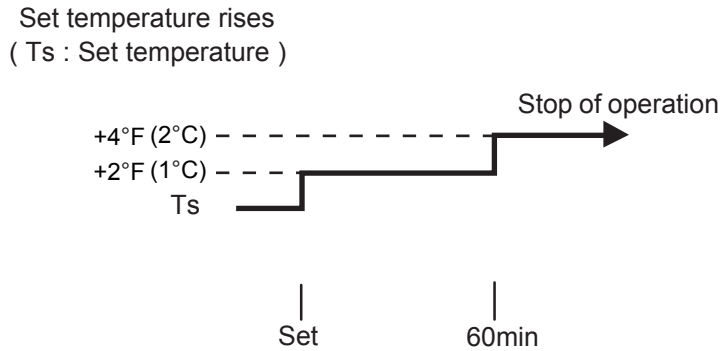

In the HEATING operation mode

When the sleep timer is set, the setting temperature is decreased 2°F (1°C). It decreases the setting temperature another 2°F (1°C) every 30 minutes. Upon lowering 8°F (4°C), the setting temperature is not changed and the operation stops at the time of timer setting.

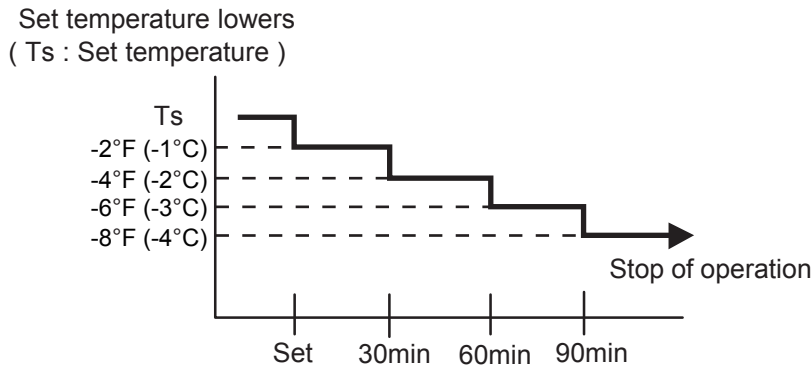

4. WEEKLY TIMER

ON and OFF timer can be combined, and up to 4 reservations per day and 28 reservations per week. Before setting the program, please set the week and time of the air conditioner first. If the week and time are not set, the weekly timer will not operate correctly at the set time.

1-9-2 Wired Remote Controller

AR-WEC1E(2 wire remote controller)

- ON / TIMER
- OFF / TIMER
- WEEKLY TIMER

*3 wire remote controller can be connected

If 3 wire remote controller is connected, set the DIP-SW on the controller PCB

Refer to the installation manual for detailed.

If used in combination with wireless and wired remote controller, the following function is limited.

- Sleep timer
- Timer
- 10°C heat operation

1. ON / OFF TIMER

- OFF timer : When the clock reaches the set time, the air conditioner will be turned off.

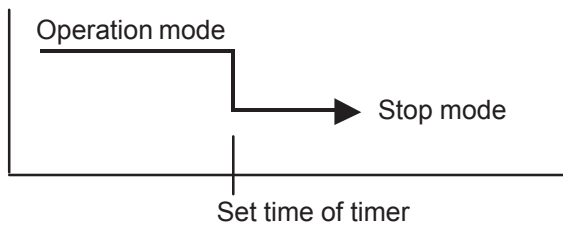

- ON timer : When the clock reaches the set time, the air conditioner will be turned on.

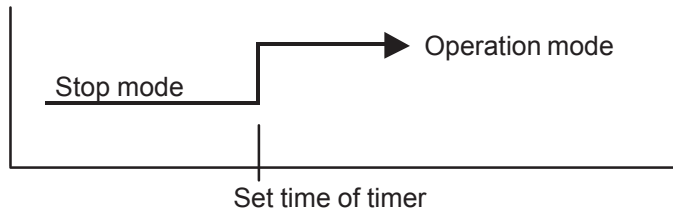

2. WEEKLY TIMER

2-1. WEEKLY TIMER

- Use this timer function to set operating time for each day of the week.
- The weekly timer allows up to two ON and OFF time to set up per day.

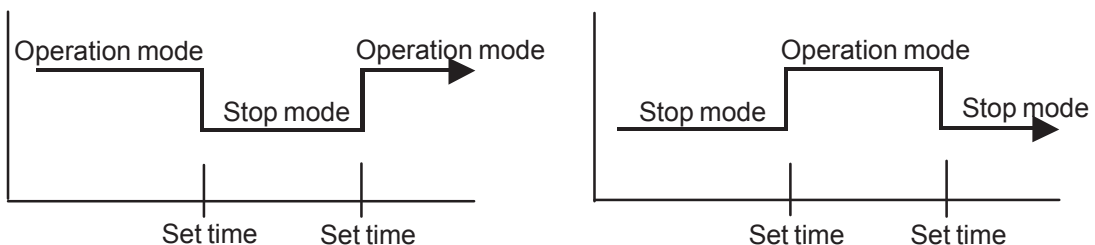

- The operating time can be set in 30 min increments only.
- The OFF time can be carried over to next day.
- The ON timer and the OFF timer functions cannot be set with using the weekly timer. Both ON and OFF time must be set.

2-2. DAY OFF setting

- The DAY OFF setting is only available for days for which weekly settings already exist.
- If the operating time carries over to the next day (during a next day setting), the effective DAY OFF range will be set as shown below.

• Normal

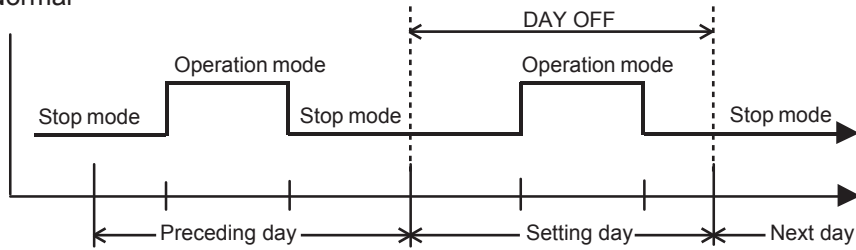

• Next day setting

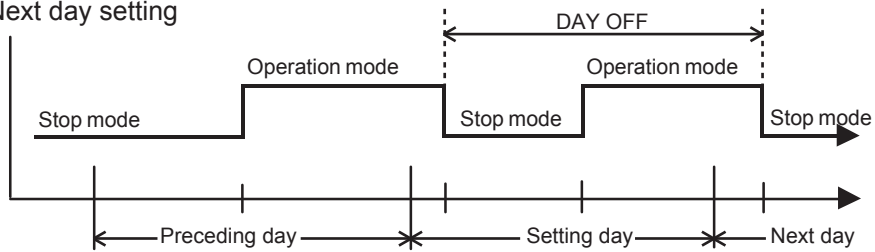

- The DAY OFF setting can only be set one time. The DAY OFF setting is cancelled automatically after the set day has passed.

1-10. ELECTRONIC EXPANSION VALVE CONTROL

The most proper opening of the electronic expansion valve is calculated and controlled under the present operating condition based on the following values.

The compressor frequency, the temperatures detected by the discharge temperature sensor, the indoor heat exchanger sensor, the outdoor heat exchanger sensor, and the outdoor temperature sensor.

(Table 13 : The pulse range of the electronic expansion valve control)

	Operation	Pulse range
AOU30RLXEH	Cooling / Dry	50 ~ 480 pulse
	Heating	60 ~ 480 pulse

The EEV is set up at 480 pulses when the compressor is stopped.

Initialization (Input of 528 pulses toward closing direction) is operated under the following condition.

* When the power is turned on.

* 4 hours has passed since the last initialization, and 3 minutes has passed after the compressor stop.
(If 12 hours has passed since the last initialization, the compressor is compulsorily stopped.)

1-11. TEST OPERATION CONTROL

▪ With Wireless Remote Controller

Under the condition where the air conditioner runs, press the TEST RUN button, and the test operation control mode will appear.

During test running, the Operation LED and Timer LED of the air conditioner body blinks simultaneously. Set the test operation mode, and the compressor will continue to run regardless of whether the room temperature sensor detects.

The test operation mode is released if 60 minutes have passed after setting up the test operation.

▪ With Wired Remote Controller

Under the condition where the air conditioner stops, press the MASTER CONTROL button and the FAN CONTROL button simultaneously for 2 seconds or more, and the test operation control mode will appear.

During test running, "a f" will display on the remote controller display.

Set the test operation mode, and the compressor will continue to run regardless of whatever the room temperature sensor detects.

The test operation mode is released if 60 minutes have passed after setting up the test operation.

UTY-RVNUM

Press the [Menu button] twice while "Monitor" screen is displayed, it switches to the "Submenu" screen.

Press the [Screen switch button (Left)] and [Screen switch button (Right)] simultaneously for 5 seconds to switch to "Service" screen.

Select [Test run] with the [Cursor button (Up/Down)] and press the [Enter button],

To start the test run, select "Yes" with the [Cursor button (Left/Right)], and press the [Enter button].

In Set temp., test run is displayed.

▪ With Outdoor Unit

Make sure that the outdoor unit in standby mode (LED POWER/MODE lights up)

Press the ENTER button for more than 3 seconds.

Select the operation mode (Cool / Heat) by SELECT button.

(L3 blink: Cool / L2 blink: Heat)

TEST operation starts by pressing ENTER button.

(L3 lights ON: test in cooling / L2 lights ON: test in heating)

By pressing ENTER button, the test operation stops.

1-12. PREVENT TO RESTART FOR 3 MINUTES (3 MINUTES ST)

The compressor won't enter operation status for 3 minutes after the compressor is stopped, even if any operation is given.

1-13. 4-WAY VALVE EXTENSION SELECT

At the time when the air conditioner is switched from the Cooling mode to Heating mode, the compressor is stopped, and the 4-way valve is switched in 3 minutes later after the compressor stopped.

1-14. AUTO RESTART

When the power was interrupted by a power failure, etc. during operation, the operation contents at that time are memorized and when power is recovered, operation is automatically resumed with the memorized operation contents.

When the power is interrupted and recovered during timer operation, timer operation is canceled, but only setting time is memorized.

[Operation contents memorized when the power is interrupted]

- Operation mode
- Set temperature
- Set air flow
- Timer mode and timer time (Set by wireless remote controller)
- MIN. HEAT (Wireless remote controller is in use)
- ECONOMY
- Air flow direction (Swing setting)
- Individual air flow direction (Swing setting)
- Human sensor auto saving (setting/timer)
- Human sensor auto off (setting/timer)
- Energy saving setting
- Each central setting

1-15. MANUAL AUTO OPERATION (When using the Wireless RC)

If MANUAL / AUTO Button is pushed for less than 10 seconds, the operation is controlled as shown in Table 9.

If the remote control is lost or battery power dissipated, this function will work without the remote control.

(Table 14 : Manual auto operation)

Operation mode	Auto changeover
Setting temp.	75°F (24°C)
Fan control mode	Auto
Timer mode	Continuous (No timer setting available)
Vertical louver	Normal
Horizontal louver	Normal
Swing	OFF
Economy	OFF

1-16. COMPRESSOR PREHEATING

When the outdoor temperature is lower than 68°F (20°C) and the all operation mode has been stopped for 30 minutes, power is applied to the compressor and the compressor is heated. (By heating the compressor, warm air is quickly discharged when operation is started.)

When operation was started and when the outdoor temperature rises to 78.8°F (26°C) or greater, preheating is ended.

1-17. POWERFUL OPERATION

The POWERFUL OPERATION functions by pressing POWERFUL button on the remote controller. The indoor unit & outdoor unit will operate at maximum power as shown in Table 16.

(Table 16 : Powerful operation)

	Powerful operation
COMPRESSOR FREQUENCY	Maximum
FAN CONT. MODE	Powerful
SETTING LOUVER	Cooling/ Dry : 3, Heating : 5

Release Condition is as follows.

[Cooling / Dry]

- Room temperature \leq Setting temperature -1°F(- 0.5°C) or Operation time has passed 20 minutes.

[Heating]

- Room temperature \geq Setting temperature +1°F(+ 0.5°C) or Operation time has passed 20 minutes.

1-18. MINIMUM HEAT OPERATION

The MINIMUM HEAT operation functions by pressing MIN. HEAT button on the remote controller. The MINIMUM HEAT operation can be set by the wireless remote controller.

* The timer and MINIMUM HEAT (Wireless R.C. only) functions of the remote controller specified as the secondary cannot be used.

(Table 17 : Minimum heat operation)

Mode	Heating
Setting temperature	50°F (10°C)
Fan mode	AUTO

1-19. ECONOMY OPERATION

The ECONOMY operation functions by pressing ECONOMY button on the remote controller. The ECONOMY operation is almost the same operation as below settings.

(Table 18 : Economy operation)

Mode	Cooling/ Dry	Heating
Target temperature	Setting temp.+2°F (+1°C)	Setting temp.-2°F (-1°C)

1-20. COMPRESSOR STOP CONTROL

When the detection value of outdoor temperature sensor is lower than temperature I in the table below, the compressor is stopped.

(Table 19 : Operation temperature of compressor stop control)

	Temperature I	
	Cooling	Heating
Operation temperature	-13°F (-25°C)	-4°F (-20°C)
Maximum frequency	110 rps	
Release temperature	-4°F (-20°C)	5°F (-15°C)

1-21. LOW NOISE OPERATION

The compressor speed and the outdoor unit fan speed are limited to reduce the operation noise by External Input.

During the LOW NOISE OPERATION, "CURRENT OVERLOAD OPERATION", "ECONOMY OPERATION" and "PEAK CUT OPERATION" are effective, and the outdoor unit operates by lowest current of them.

However, during the DEFROST OPERATION, the compressor operates by the speed for DEFROST OPERATION.

(Table 20 : Detail of low noise operation)

Low Noise mode		Compressor speed [rps]	Outdoor fan speed (Upper / Lower) [rpm]
LEVEL 1	Cooling	50	520/520
	Heating	46	
LEVEL 2	Cooling	36	
	Heating	37	

*The performance drops when operating in the LOW NOISE OPERATION.

Capacity priority mode

(1) Operation condition

- The function setting is set the "1" for the capacity priority mode.

(2) Check the capacity condition

Shortage	Required compressor speed > Limited compressor speed of low noise mode
Enough	Required compressor speed \leq Limited compressor speed of low noise mode

(3) Operation

- When detect the shortage capacity or enough capacity condition continuous 30 minute, the mode is upped or downed for 1 step.

Automatic switching 1
Level 1 setting

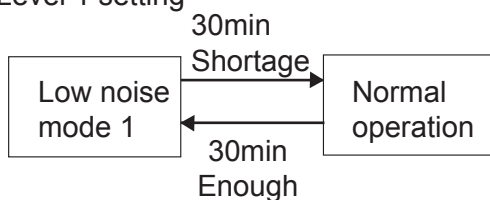

Automatic switching 2
Level 2 setting

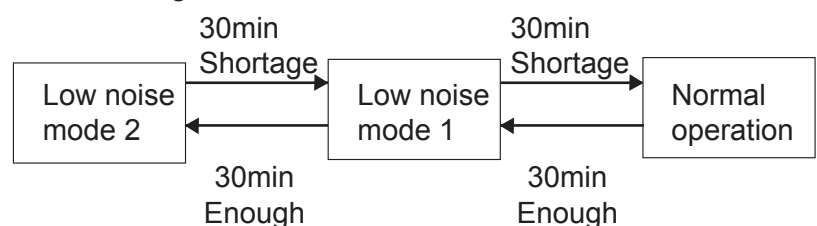

1-22. HUMAN SENSOR OPERATION

The HUMAN SENSOR functions by pressing SENSOR button on the remote controller. When the sensor detects that there is no one in the room for 20 minutes or more, it automatically changes the operation as below settings. When someone comes back into the room, the human sensor will detect this, and automatically revert to the original settings.

(Table 21 : Human sensor control)

Mode	Cooling/ Dry	Heating
Target temperature	Setting temp.+4°F(+2°C)	Setting temp.-8°F(-4°C)

(Application range)

Vertical angle 90°(Side view)

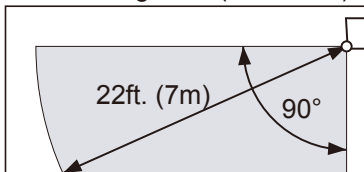

Horizontal angle 100°(Top view)

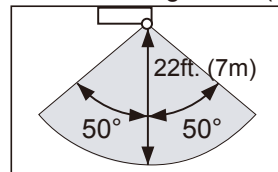

※ The sensor unit should detect when the human body (estimate: 150cmX30cm) or the object which has more than 8 °F(4°C) temp, difference from the background and are crossed with 1.0m/s speed in front of the sensor unit.

1-23. BASE HEATER OPERATION

The base heater is operated as shown in Fig. 13 .

(Fig.13 : Base heater control)

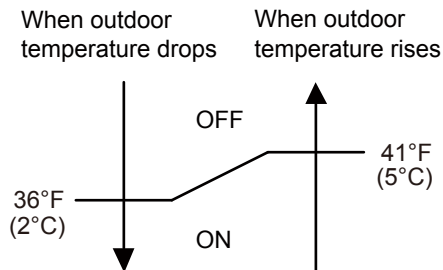

- * When the compressor stops, Base heater is OFF.
- * When the outdoor fan motor stops, Base heater is OFF.
- * In the cooling mode, Base heater is OFF.
- * After defrost, it will turn OFF the heater (Comp Accumulated operation time) after 15 minutes.

1-24. PEAK CUT OPERATION

The Current Value is limited to reduce the power consumption by External Input. During the PEAK CUT OPERATION , "CURRENT OVERLOAD OPERATION", "ECONOMY OPERATION" and "LOW NOISE OPERATION" are effective, and the outdoor unit operates by lowest current of them. However, this function becomes invalid during DEFROST OPERATION.

(Table 22 : Outline of peak cut operation)

PEAK CUT LEVEL	LEVEL 1	LEVEL 2	LEVEL 3	LEVEL 4
Peak Cut For Rated Capacity	Forced thermostat-OFF	50%	75%	100%

*Percentage is rated electrical power ratio.

1-25. FORCED COOLING OPERATION (When using the Wireless RC)

The FORCED COOLING OPERATION starts up when MANUAL / AUTO button is pressed more than 10 seconds. During the FORCED COOLING OPERATION, it keeps operation regardless of detection value of room temperature sensor.

Operation LED and Timer LED blinks simultaneously while the unit is on the FORCED COOLING OPERATION. It is released after 60 minutes from starting time.

1-26. HEAT INSULATION CONDITION (BUILDING INSULATION)

This setting can make the room temperature control more suitable for homes or buildings with high insulation (Function Number 95).

When the thermo sensor is turned ON it controls the compressor frequency at initial start to prevent overshoot in heating or cooling.

1-27. THERMO CONTROL (FOR INDOOR UNIT SENSOR)

When room temperature is controlled by the Indoor unit sensor, compressor operation is as shown in Fig. 14 and 15 .

But, adjustment is possible by the room temperature correction function setting. (Function Number 30 or 31)

(Fig. 14 : For cooling operation)

(Fig. 15 : For heating operation)

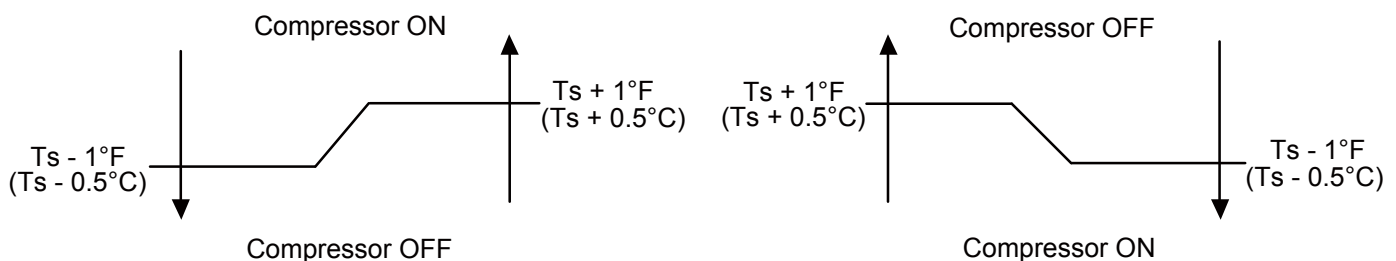

• T_s : Setting temperature

1-28. THERMO CONTROL (FOR WIRED REMOTE SENSOR)

When room temperature is controlled by the Wired remote sensor, compressor operation is as shown in Fig. 16 and 17 .

But, adjustment is possible by the room temperature correction function setting. (Function Number 92 or 93)

(Fig. 16 : For cooling operation)

(Fig. 17 : For heating operation)

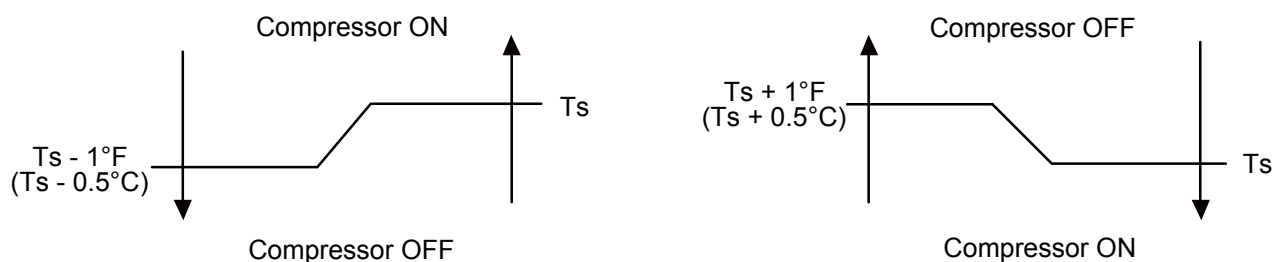

• T_s : Setting temperature

1-29. PUMP DOWN

⚠ WARNING

Never touch electrical components such as the terminal blocks except the button on the display board. It may cause a serious accident such as electric shock.

During the pump-down operation, make sure that the compressor is turned off before you remove the refrigerant piping.
Do not remove the connection pipe while the compressor is in operation with 2-way or 3-way valve open. This may cause abnormal pressure in the refrigeration cycle that leads to breakage and even injury.

⚠ CAUTION

Perform the pump down operation before disconnecting any refrigerant pipe or electric cable.

Collect refrigerant from the service port or the 3-way valve if pump down cannot be performed.

In case of a group control system installation, do not turn the power off pump down is completed in all outdoor units.
(Group control system installation described in "SPECIAL INSTALLATION METHODS" in the installation manual of the indoor unit.)

Please check the refrigerant circuit for any leaks before starting the pump down operation.
Do not proceed with the pump down operation if there is no refrigerant left in the circuit due to bent or broken piping.

- Operate "PUMP DOWN" button on the display board in the manner described below.

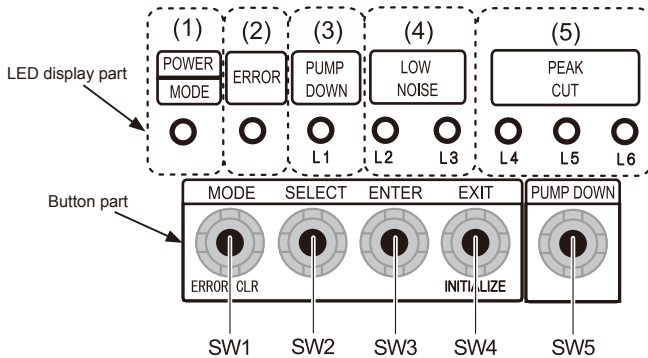

16.1. Preparation for pump down

- Confirm that the power is off, and then open the service panel.

16.2. Pump down procedure

- Check the 3-way valves (both the liquid side and gas side) are opened.
- Turn the power on.

POWER/ MODE	ERROR	PUMP DOWN	LOW NOISE			PEAK CUT		
		(L1)	(L2)	(L3)	(L4)	(L5)	(L6)	
●	○	○	○	○	○	○	○	○

Sign "○": Lights off, "●": Lights on

- Press "PUMP DOWN" button for 3 seconds or more after 3 minutes after power on.

POWER/ MODE	ERROR	PUMP DOWN	LOW NOISE			PEAK CUT		
		(L1)	(L2)	(L3)	(L4)	(L5)	(L6)	
●	○	●	○	○	○	●	●	●

Sign "○": Lights off, "●": Lights on

LED display lights on as shown in the above figure, and the fans and the compressor start operating.

- If the "PUMP DOWN" button is pressed while the compressor is operating, the compressor will stop, then start again in about 3 minutes.
- LED display will change as shown below about 3 minutes after the compressor starts. Fully close the 3-way valve on the liquid pipe side at this stage.

POWER/ MODE	ERROR	PUMP DOWN	LOW NOISE			PEAK CUT		
		(L1)	(L2)	(L3)	(L4)	(L5)	(L6)	
●	○	●	○	○	○	●	●	●

Sign "○": Lights off, "●": Lights on

- If the valve on the liquid pipe side is not closed, the pump down cannot be performed.
- When LED display changes as shown in the below figure, close the 3-way valve on the gas pipe side tightly.

POWER/ MODE	ERROR	PUMP DOWN	LOW NOISE			PEAK CUT		
		(L1)	(L2)	(L3)	(L4)	(L5)	(L6)	
●	○	●	○	○	○	○	○	●

Sign "○": Lights off, "●": Lights on

- If the valve on the gas pipe side is not closed, refrigerant may flow into the piping after the compressor stops.

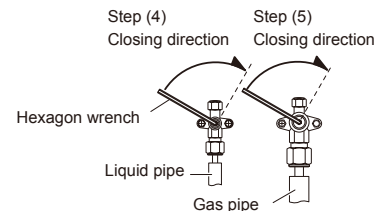

- LED display changes after 1 minute as shown in the figure below.

POWER/ MODE	ERROR	PUMP DOWN	LOW NOISE			PEAK CUT		
		(L1)	(L2)	(L3)	(L4)	(L5)	(L6)	
●	○	●	○	○	○	○	○	○

Sign "○": Lights off, "●": Lights on

Fans and compressor stop automatically.

- If the pump down is successfully completed (the above LED display is shown), the outdoor unit remains stopped until the power is turned off.

- Turn the power off.

POWER/ MODE	ERROR	PUMP DOWN	LOW NOISE			PEAK CUT		
		(L1)	(L2)	(L3)	(L4)	(L5)	(L6)	
○	○	○	○	○	○	○	○	○

Sign "○": Lights off

PUMP DOWN is completed.

(Note)

- To stop pump down, press the "PUMP DOWN" button again.
- To start the pump down again after the compressor is automatically stopped due to an error, turn the power off and open the 3-way valves. Wait 3 minutes, turn the power on and start the pump down again.
- When starting the operation after completion of the pump down, turn the power off, and then open the 3-way valves. Wait 3 minutes, turn the power on and perform a test run in the "COOL" operation mode.
- If an error occurs, recover the refrigerant from service port.

1-30. DEFROST OPEARTION CONTROL

1. CONDITION OF STARTING THE DEFROST OPERATION

The defrost operation starts as shown in the following Table 23, 24, 25 and 26.

(Table 23 : Condition of 1st defrost operation)

1st defrost after starting operation	Compressor integrating operation time		
	Less than 17 minutes	More than 17 minutes	More than 57 minutes
Does not operate		$T_n \leq 15.8^{\circ}\text{F}(-9^{\circ}\text{C})$ and $T_a - T_n \geq 41^{\circ}\text{F}(5^{\circ}\text{C})$ (and after 5 minutes, in the $41^{\circ}\text{F}(5^{\circ}\text{C})$)	$T_n \leq 23^{\circ}\text{F}(-5^{\circ}\text{C})$ (and after 5 minutes, if the $23^{\circ}\text{F}(-5^{\circ}\text{C})$)

T_n : Outdoor heat exchanger temperature.
 T_a : Outdoor temperature.

(Table 24 : Condition of 2nd defrost operation)

From 2nd and later defrost after starting operation	Compressor integrating operation time	
	Less than 35 minutes	More than 35 minutes
Does not operate		① $T_n \leq -77^{\circ}\text{F}(-25^{\circ}\text{C})$ ② $T_n - T_{n10} < -41^{\circ}\text{F}(5^{\circ}\text{C})$ ($T_n \leq -42.8^{\circ}\text{F}(6^{\circ}\text{C})$) ③ $T_n - T_{nb} < -35.6^{\circ}\text{F}(2^{\circ}\text{C})$ ($T_n \leq -42.8^{\circ}\text{F}(6^{\circ}\text{C})$)

T_{n10} : Temperature of continuous operation at 10 minutes.
 T_{nb} : Back 5 minutes temperature.

(Table 25 : Condition of Integrating defrost operation)

Integrating defrost	Compressor integrating operation time	
	More than 210 minutes (For long continuous operation)	More than 210 minutes (For long continuous operation)
	$T_n \leq 26.6^{\circ}\text{F}(-3^{\circ}\text{C})$ (and after 30 minutes, if the $26.6^{\circ}\text{F}(-3^{\circ}\text{C})$)	$T_n \leq 23^{\circ}\text{F}(-5^{\circ}\text{C})$ (and after 5 minutes, if the $23^{\circ}\text{F}(-5^{\circ}\text{C})$)

(Table 26 : Condition of Integrating (OFF count) defrost operation)

Integrating defrost (OFF count defrost)	Compressor integrating operation time
	Less than 10 minutes* (For intermittent operation) OFF count of the compressor : 40 times

*If the compressor continuous operation time is less than 10 minutes, the OFF number of the compressor is counted.
 If any defrost operated, the compressor OFF count is cleared.

2. CONDITION OF THE DEFROST OPERATION COMPLETION

Defrost operation is released when the conditions becomes as shown in Table 27.

(Table 27 : Condition of defrost release)

Release Condition
Outdoor heat exchanger temperature is higher than $55.4^{\circ}\text{F}(13^{\circ}\text{C})$ or Compressor operation time has passed 15 minutes.

3. Defrost Flow Chart

The defrosting shall proceed by the integrating operation time, outdoor temperature and outdoor heat exchanger temperature as follows.

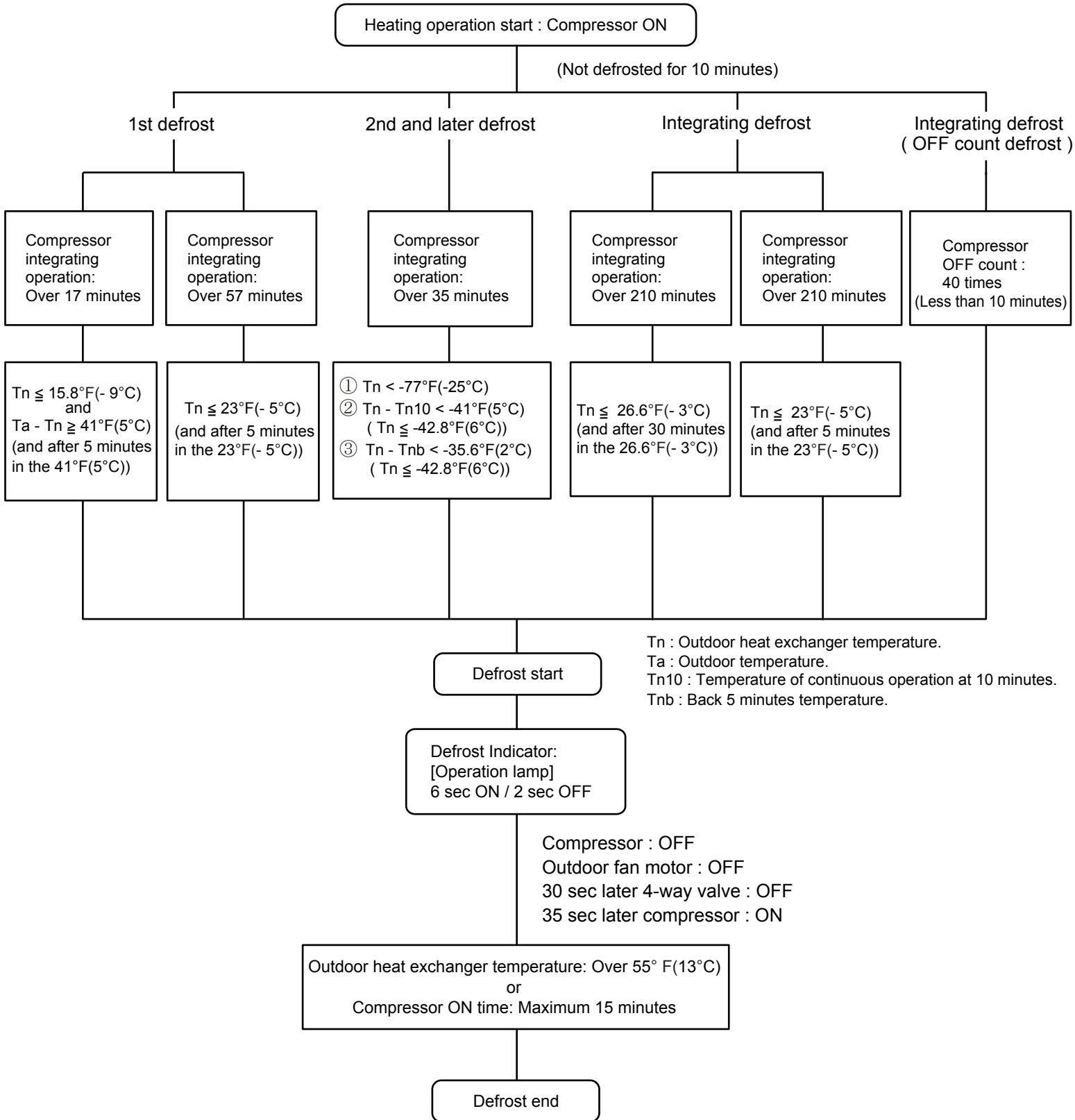

1-31. OFF DEFROST OPEARTION CONTROL

When operation stops in the [Heating operation] mode, if frost is adhered to the outdoor unit heat exchanger, the defrost operation will proceed automatically. In this time, if indoor unit operation lamp flashes slowly (7 sec ON / 2 sec OFF), the outdoor unit will allow the heat exchanger to defrost, and then stop.

1. OFF DEFROST OPERATION CONDITION

In heating operation, the outdoor heat exchanger temperature is less than 24.8°F (-4°C), and compressor operation integrating time lasts for more than 30 minutes.

2. OFF DEFROST RELEASE CONDITION

OFF defrost operation is released when the conditions becomes as shown in Table 28.

(Table 28 : OFF Defrost release condition)

Release Condition
Outdoor heat exchanger temp. is higher than 53.6°F (12°C) or Compressor operation time has passed 15 minutes.

OFF Defrost Flow Chart

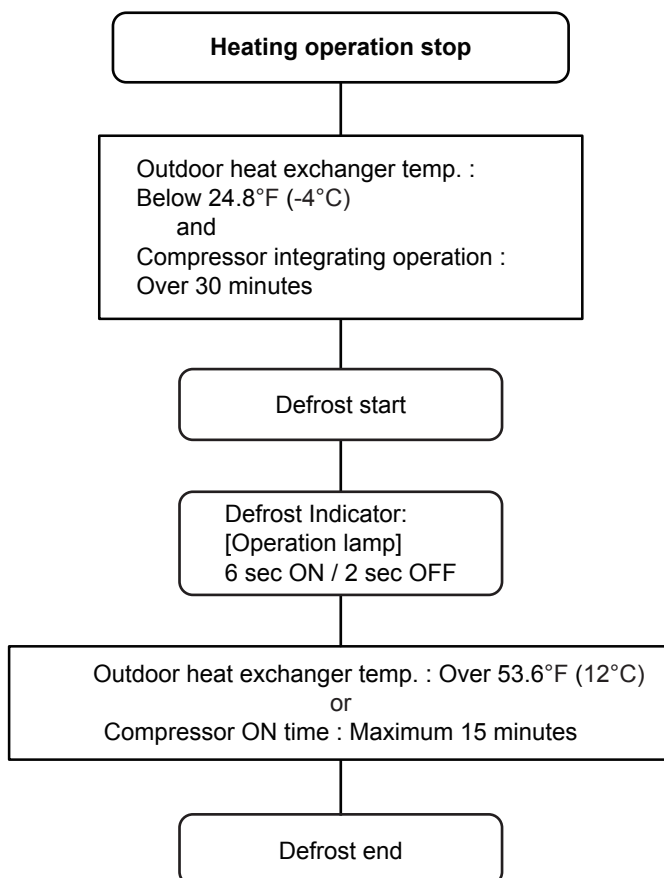

1-32. VARIOUS PROTECTIONS

1. DISCHARGE GAS TEMPERATURE OVERRISE PREVENTION CONTROL

The discharge gas thermosensor (discharge thermistor : Outdoor side) will detect discharge gas temperature.

When the discharge temperature becomes higher than Temperature I ,the compressor frequency is decreased 10rps, and it continues to decrease the frequency for 10rps every 120 seconds until the temperature becomes lower than Temperature I .

When the discharge temperature becomes lower than Temperature II , the control of the compressor frequency is released.

When the discharge temperature becomes higher than Temperature III, the compressor is stopped and the indoor unit LED starts blinking.

(Table 29 : Discharge temperature over rise prevention control / Release temperature)

Temperature I	Temperature II	Temperature III
221°F (105°C)	212°F (100°C)	239°F (115°C)

2. CURRENT RELEASE CONTROL

The compressor frequency is controlled so that the outdoor unit input current does not exceeds the current limit value that was set up with the outdoor temperature.

The compressor frequency returns to the designated frequency of the indoor unit at the time when the frequency becomes lower than the release value.

(Table 30 : Operation value / Release value Ta: Outdoor temperature)

[Heating]

	Outdoor unit fan speed (UP / LO)				
	870/840rpm	780/750rpm	520/520rpm	350/350rpm	200/200rpm
68.0°F (20°C) ≤ Ta	14.5A/14.0A				
53.6°F (12°C) ≤ Ta < 68.0°F (20°C)	16.5A/16.0A				
Ta < 53.6°F (12°C)	19.5A/19.0A				

[Cooling]

	Outdoor unit fan speed (UP / LO)							
	850/800rpm	780/750rpm	520/520rpm	350/350rpm	280/280rpm	480/ 0rpm	400/ 0rpm	280/ 0rpm
122°F (50°C) ≤ Ta	9.5A/9.0A		6.5A/6.0A	5.0A/4.5A				
114.8°F (46°C) ≤ Ta < 122°F (50°C)	13.5A/13.0A	12.5A/12.0A	9.0A/8.5A	6.0A/5.5A				
104.0°F (40°C) ≤ Ta < 114.8°F (46°C)	17.5A/17.0A		10.0A/9.5A	9.0A/8.5A		6.0A/5.5A		
100.4°F (38°C) ≤ Ta < 104.0°F (40°C)	19.0A/18.5A	13.5A/13.0A		10.0A/9.5A	9.0A/8.5A		6.0A/5.5A	
87.8°F (31°C) ≤ Ta < 100.4°F (38°C)	14.5A/14.0A		10.0A/9.5A		9.0A/8.5A		6.0A/5.5A	
66.2°F (19°C) ≤ Ta < 87.8°F (31°C)	15.0A/14.5A		11.0A/10.5A		10.0A/9.5A		6.0A/5.5A	
55.4°F (13°C) ≤ Ta < 66.2°F (19°C)	13.5A/13.0A		10.5A/10.0A		9.0A/8.5A		6.0A/5.5A	
44.6°F (7°C) ≤ Ta < 55.4°F (13°C)	12.5A/12.0A		9.0A/8.5A		8.0A/7.5A		6.0A/5.5A	
32.0°F (0°C) ≤ Ta < 44.6°F (7°C)	19.5A/19.0A	19.0A/18.5A	16.0A/15.5A		12.5A/12.0A		12.0A/11.5A	
23.0°F (-5°C) ≤ Ta < 32.0°F (0°C)	16.0A/15.5A		14.5A/14.0A		12.0A/11.5A		12.5A/12.0A	
14.0°F (-10°C) ≤ Ta < 23.0°F (-5°C)	15.5A/15.0A		12.5A/12.0A		12.5A/12.0A		12.5A/12.0A	
5.0°F (-15°C) ≤ Ta < 14.0°F (-10°C)	16.5A/16.0A		13.0A/12.5A		13.0A/12.5A		8.0A/7.5A	
Ta < 5.0°F (-15°C)	16.5A/16.0A		13.0A/12.5A		13.0A/12.5A		8.0A/7.5A	

3. ANTIFREEZING CONTROL (Cooling and Dry mode)

The compressor frequency is decrease on cooling & dry mode when the indoor heat exchanger temperature sensor detects the temperature lower than Temperature I. Then, the anti-freezing control is released when it becomes higher than Temperature II.

(Table 31 : Anti-freezing protection operation / Release temperature)

Outdoor temperature	Temperature I	Temperature II
Over than 10°C *1 or 12°C *2	39.2°F (4°C)	44.6°F (7°C)
Less than 10°C *1 or 12°C *2		55.4°F (13°C)

*1. When the temperature rises.

*2. When the temperature drops.

4. COOLING PRESSURE OVER RISE PROTECTION

On cooling mode, the compressor frequency is controlled as following based on the detection value of the outdoor heat exchanger temperature sensor.

(Fig.18 : Cooling pressure over rise protection control)

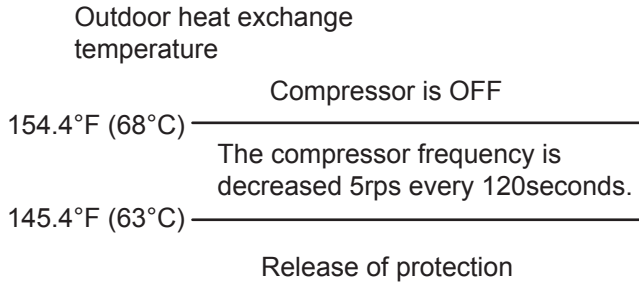

5. LOW PRESSURE PROTECTION CONTROL (For Cooling mode)

5-1. Low Pressure Protection 1

<After the compressor start-up and 1 minute has passed>

- (a).The detected value of pressure sensor is 17.4 psi(0.02MPaG) or less, continues for 5 minutes, the compressor is stopped.
- (b). When 7 minutes has passed and low pressure sensor detects value is more than 21.8 psi(0.05MPaG) after the protection stop by (a), the compressor restarts.
- (c).When the protection (a) operates 5 times within 2 hours after the restart by (b), the error is displayed and the compressor stops. **[Permanent stop]**

(Fig. 19 : Low pressure protection 1)



5-2. Low Pressure Protection 2

<After the compressor start-up and 10 minutes has passed>

- (a).When the low pressure value becomes ??? psi(0.68MPaG) or less continues for 1 minute, the compressor speed -8 rps.
- (b). When the low pressure value becomes ??? psi(0.68MPaG) or less after the protection (a), the compressor continues speed -8 rps every 1 minute until the detected value becomes more than ??? psi (0.68MPaG).
- (c). When the low pressure value becomes more than 0.78MPaG, this protection is released.

(Fig. 20 : Anti freezing protection)

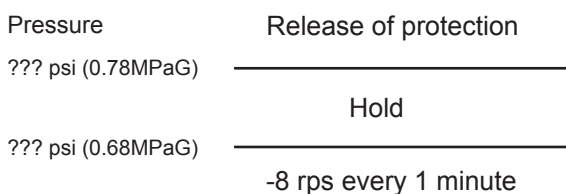

1-33. DESCRIPTION OF DISPLAY UNIT

1-33-1 Layout of Display Unit

- Various settings can be adjusted by changing Push switches on the board of the outdoor unit.
(Excerpt from the "INSTALATION MANUAL")

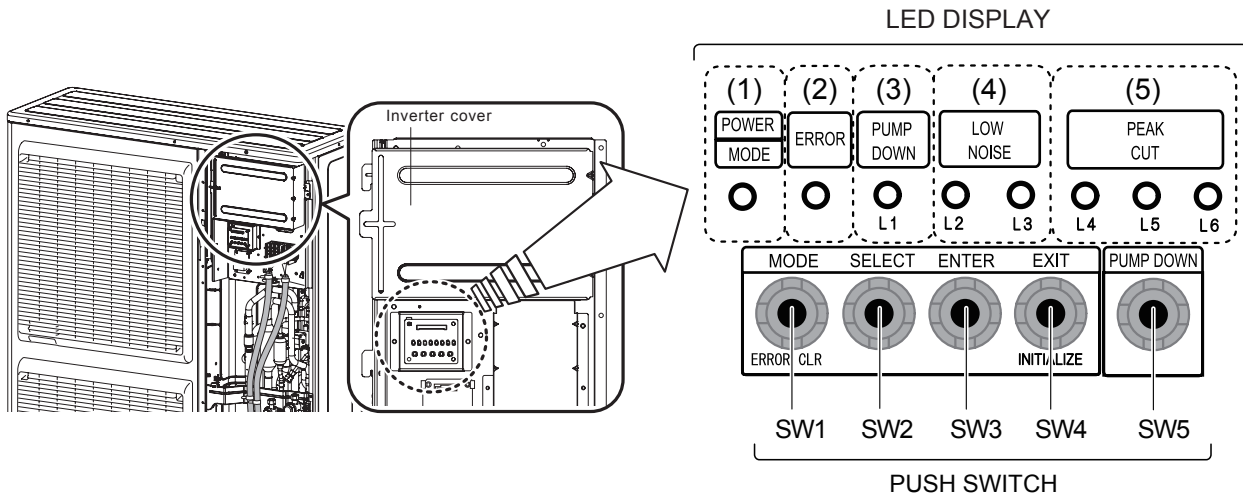

Display lamp		Function or operation method
(1) POWER / MODE	Green	Lights on while power on. Local setting in outdoor unit or error code is displayed with blink.
(2) ERROR	Red	Blinks during abnormal air-conditioner operation.
(3) PUMP DOWN (L1)	Orange	Lights on during pump down operation.
(4) LOW NOISE MODE (L2, L3)	Orange	Lights on during "Low noise" mode when local setting is activated. (Lighting pattern of L2 and L3 indicates low noise level)
(5) PEAK CUT (L4, L5, L6)	Orange	Lights on during "Peak cut" mode when local setting is activated. (Lighting pattern of L4, L5 and L6 indicates peak cut level)

Switch		Function or operation method
MODE	SW1	To switch between "Local setting" and "Error code display".
SELECT	SW2	To switch between the individual "Local settings" and the "Error code displays".
ENTER	SW3	To fix the individual "Local settings" and the "Error code displays".
EXIT / INITIALIZE	SW4	To return to "Operation status display".
PUMP DOWN	SW5	To start the pump down operation.

1-33-2 Display mode

- In this mode, the "Operation Condition" and "Error Code" can be displayed by Push Switch on outdoor unit PCB

(Table 32 : Procedure for present value) ○ : Light OFF ● : Light ON ◐ : Blinking ◆1 : 1 Time Blinking

Procedure	Operation	Power Mode	Error	L1	L2	L3	L4	L5	L6
1	During status display, press the MODE SWITCH 1 time. (Status display : Outdoor unit is stopping and no error)	◆1	○	○	○	○	○	○	○
2	When the POWER / MODE LED blinking 1 time, press the ENTER SWITCH.	◆1	○	○	○	◐	○	○	○
3	Press the SELECT SWITCH and adjust to DISPLAY ITEM (from L1 to L3) that you want to confirm. (Refer to Table : 32)	◆1	○	○	◐	○	○	○	○
4	Press the ENTER SWITCH. (Data is displayed by lighting LED. Refer to Table : 32)	◆1	○	○	●	○	DATA		
5	Selecting display items can be done by pressing the SELECT SWITCH. (Return to Procedure 3)	◆1	○	○	◐	○	○	○	○
	When the EXIT SWITCH is pressed, this mode ends and returns to the status display.	●	○	○	○	○	○	○	○

(Table 33 : Display pattern) ○ : Light OFF ● : Light ON ◐ : Blinking ◆n : n Time Blinking

Power / Mode LED	Display Item	LED			
		ERROR	L1	L2	L3
Present Value Of Each Item ◆1	Compressor frequency	○	○	○	●
	Upper fan speed (Outdoor unit)	○	○	●	○
	Lower fan speed (Outdoor unit)	○	○	●	●
	EEV pulse	○	●	○	○
	Pressure sensor value (Low pressure range)	○	●	○	●
	Pressure sensor value (High pressure range)	○	●	●	○
	Outdoor air temperature sensor value	○	●	●	●
	Discharge temperature sensor value	●	○	○	○
	Heat-exchanger temperature sensor value (Middle)	●	○	○	●
	Current value	●	○	●	○
	Compressor accumulated time	●	○	●	●

(Table 34 : Detail of LED display data)

○ : Light OFF ● : Light ON ◆1 : 1 Time Blinking

Item No.	Display Item		Power Mode	Error	L1	L2	L3	L4	L5	L6
1	Compressor Frequency (0 ~ 95rps)	0	◆1	○	○	○	●	○	○	○
		1 ~ 15	◆1	○	○	○	●	○	○	●
		16 ~ 30	◆1	○	○	○	●	○	●	○
		31 ~ 45	◆1	○	○	○	●	○	●	●
		46 ~ 60	◆1	○	○	○	●	●	○	○
		61 ~ 75	◆1	○	○	○	●	●	○	●
		76 ~ 90	◆1	○	○	○	●	●	●	○
		90 ~ 95	◆1	○	○	○	●	●	●	●
2	Outdoor Unit Upper Fan Speed (0 ~ 900rpm)	0	◆1	○	○	●	○	○	○	○
		1 ~ 150	◆1	○	○	●	○	○	○	●
		151 ~ 300	◆1	○	○	●	○	○	●	○
		301 ~ 450	◆1	○	○	●	○	○	●	●
		451 ~ 600	◆1	○	○	●	○	●	○	○
		601 ~ 750	◆1	○	○	●	○	●	○	●
		751 ~ 900	◆1	○	○	●	○	●	●	○
		901 ~	◆1	○	○	●	○	●	●	●
3	Outdoor Unit Lower Fan Speed (0 ~ 900rpm)	0	◆1	○	○	●	●	○	○	○
		1 ~ 150	◆1	○	○	●	●	○	○	●
		151 ~ 300	◆1	○	○	●	●	○	●	○
		301 ~ 450	◆1	○	○	●	●	○	●	●
		451 ~ 600	◆1	○	○	●	●	●	○	○
		601 ~ 750	◆1	○	○	●	●	●	○	●
		751 ~ 900	◆1	○	○	●	●	●	●	○
		901 ~	◆1	○	○	●	●	●	●	●
4	EEV Pulse (0 ~ 480pulse)	0	◆1	○	●	○	○	○	○	○
		1 ~ 80	◆1	○	●	○	○	○	○	●
		81 ~ 160	◆1	○	●	○	○	○	○	○
		161 ~ 240	◆1	○	●	○	○	○	○	●
		241 ~ 320	◆1	○	●	○	○	○	○	○
		321 ~ 400	◆1	○	●	○	○	○	○	○
		401 ~ 480	◆1	○	●	○	○	○	○	○
		481 ~	◆1	○	●	○	○	○	○	○
5	Pressure sensor value <Low pressure range> (0 ~ 304.58psi) (0 ~ 2.1MPa) Check the High Pressure Range if it is displayed [1.81 ~ 2.1]	~ 0.0	◆1	○	●	○	●	○	○	○
		0.01 ~ 0.3	◆1	○	●	○	●	○	○	●
		0.31 ~ 0.6	◆1	○	●	○	●	○	○	○
		0.61 ~ 0.9	◆1	○	●	○	●	○	○	●
		0.91 ~ 1.2	◆1	○	●	○	●	○	○	○
		1.21 ~ 1.5	◆1	○	●	○	●	○	○	○
		1.51 ~ 1.8	◆1	○	●	○	●	○	○	○
		1.81 ~ 2.1	◆1	○	●	○	●	○	○	○
6	Pressure sensor value <High pressure range> (304.58 ~ 609.16psi) (2.1 ~ 4.2MPa) Check the Low Pressure Range if it is displayed [~ 2.1]	~ 2.1	◆1	○	●	●	○	○	○	○
		2.11 ~ 2.4	◆1	○	●	●	○	○	○	○
		2.41 ~ 2.7	◆1	○	●	●	○	○	○	○
		2.71 ~ 3.0	◆1	○	●	●	○	○	○	○
		3.01 ~ 3.3	◆1	○	●	●	○	○	○	○
		3.31 ~ 3.6	◆1	○	●	●	○	○	○	○
		3.61 ~ 3.9	◆1	○	●	●	○	○	○	○
		3.91 ~ 4.2	◆1	○	●	●	○	○	○	○

○ : Light OFF ● : Light ON ◆1 : 1 Time Blinking

Item No.	Display Item		Power Mode	Error	L1	L2	L3	L4	L5	L6
7	Outdoor Air Temperature (-22 ~ 158°F) (-30 ~ 70°C)	~ -15	◆1	○	●	●	●	○	○	○
		-15 ~ -5	◆1	○	●	●	●	○	○	●
		-5 ~ 5	◆1	○	●	●	●	○	●	○
		5 ~ 15	◆1	○	●	●	●	○	●	●
		15 ~ 25	◆1	○	●	●	●	●	○	○
		25 ~ 35	◆1	○	●	●	●	●	○	●
		35 ~ 45	◆1	○	●	●	●	●	●	○
		45 ~	◆1	○	●	●	●	●	●	●
8	Discharge Temperature (-22 ~ 248°F) (-30 ~ 120°C)	~ 55	◆1	●	○	○	○	○	○	○
		55 ~ 65	◆1	●	○	○	○	○	○	●
		65 ~ 75	◆1	●	○	○	○	○	●	○
		75 ~ 85	◆1	●	○	○	○	○	●	●
		85 ~ 95	◆1	●	○	○	○	●	○	○
		95 ~ 105	◆1	●	○	○	○	●	○	●
		105 ~ 115	◆1	●	○	○	○	●	●	○
		115 ~	◆1	●	○	○	○	●	●	●
9	Heat-exchanger Temperature <Middle> (-22 ~ 176°F) (-30 ~ 80°C)	~ 53	◆1	●	○	○	●	○	○	○
		53 ~ 55	◆1	●	○	○	●	○	○	●
		55 ~ 57	◆1	●	○	○	●	○	●	○
		57 ~ 59	◆1	●	○	○	●	○	●	●
		59 ~ 61	◆1	●	○	○	●	●	○	○
		61 ~ 63	◆1	●	○	○	●	●	○	●
		63 ~ 65	◆1	●	○	○	●	●	●	○
		65 ~	◆1	●	○	○	●	●	●	●
10	Current (0 ~ 10A)	~ 0.0	◆1	●	○	●	○	○	○	○
		0.0 ~ 1.5	◆1	●	○	●	○	○	○	●
		1.5 ~ 3.0	◆1	●	○	●	○	○	●	○
		3.0 ~ 4.5	◆1	●	○	●	○	○	●	●
		4.5 ~ 6.0	◆1	●	○	●	○	●	○	○
		6.0 ~ 7.5	◆1	●	○	●	○	●	○	●
		7.5 ~ 9.0	◆1	●	○	●	○	●	●	○
		9.0 ~	◆1	●	○	●	○	●	●	●
11	Compressor Accumulated Time (H) <Round up by 1 hour>	0	◆1	●	○	●	●	○	○	○
		0 ~ 10000	◆1	●	○	●	●	○	○	●
		10000 ~ 20000	◆1	●	○	●	●	○	●	○
		20000 ~ 30000	◆1	●	○	●	●	○	●	●
		30000 ~ 40000	◆1	●	○	●	●	●	○	○
		40000 ~ 50000	◆1	●	○	●	●	●	○	●
		50000 ~ 60000	◆1	●	○	●	●	●	●	○
		60000 ~	◆1	●	○	●	●	●	●	●

1-33-3 Error history mode

• In this mode, the history of abnormality that occurred in the past can be confirmed.

(Table : 35 Procedure for history mode) ○ : Light OFF ● : Light ON ◐ : Blinking ◆2 : 2 Times Blinking ◆n : n Times Blinking

Procedure	Operation	Power	Error	L1	L2	L3	L4	L5	L6
		Mode							
1	During status display, press the MODE SWITCH 2 times. (Status display : Outdoor unit is stopping and no error)	◆2	○	○	○	○	○	○	○
2	When the POWER / MODE LED blinking 2 times, press the ENTER SWITCH.	◆2	○	○	○	◐	○	○	○
3	Press the SELECT SWITCH and adjust to DISPLAY ITEM (from L1 to L3) that you want to confirm. (Refer to Table : 36)	◆2	○	○	◐	○	○	○	○
4	Press the ENTER SWITCH, Error code is displayed by lighting LED. (Refer to TROUBLESHOOTING)	◆2	●	◆n	◆n	DATA			
5	Selecting display items can be done by pressing the SELECT SWITCH. (Return to Procedure 3)	◆2	○	○	◐	○	○	○	○
	When the EXIT SWITCH is pressed, this mode ends and returns to the status display.	●	○	○	○	○	○	○	○

(Table 36 : Display pattern)

○ : Light OFF ● : Light ON ◐ : Blinking ◆n : n Time Blinking

Power / Mode LED	Display Item	LED			
		ERROR	L1	L2	L3
Error Code ◆2	Newest error code	○	○	○	◐
	Error code before 1 time	○	○	◐	○
	Error code before 2 times	○	○	◐	◐

WALL MOUNTED type INVERTER

2 . TROUBLE SHOOTING

2-1 ERROR DISPLAY

2-1-1 INDOOR UNIT AND WIRED REMOTE CONTROLLER DISPLAY

1. ERROR DISPLAY

Please refer the blinking pattern as follows.

The Operation, Timer, Economy lamps operate as follows according to the error contents.

Error Contents	Indoor Unit Display			Wired Remote Controller Display	Trouble shooting
	Operation (Green)	Timer (Orange)	Economy (Green)		
Serial Communication Error	1 time	1 time	Blinking Hi-speed	11	1,2
Wired Remote Controller Communication Error	1 time	2 times	Blinking Hi-speed	12	3
External communication Error	1 time	8 times	Blinking Hi-speed	18	4
Combination Error	2 times	3 times	Blinking Hi-speed	23	5
Address setting Error in Wired remote controller system	2 times	6 times	Blinking Hi-speed	26	6
Connection unit number error (Indoor unit Wired remote controller Error)	2 times	9 time	Blinking Hi-speed	29	7
Indoor Unit PCB Model Information Error	3 times	2 times	Blinking Hi-speed	32	8
Manual Auto Switch Error	3 times	5 times	Blinking Hi-speed	35	9
Indoor unit (Communication circuit) WRC Error	3 times	10 times	Blinking Hi-speed	3A	10
Indoor Room Thermistor Error	4 times	1 time	Blinking Hi-speed	41	11
Indoor Heat Ex. Thermistor Error	4 times	2 times	Blinking Hi-speed	42	12
Indoor Unit Fan Motor Error	5 times	1 time	Blinking Hi-speed	51	13
Outdoor Unit Main PCB Model Information Error	6 times	2 times	Blinking Hi-speed	62	14
Inverter Error	6 times	3 times	Blinking Hi-speed	63	15
Active Filter Error	6 times	4 times	Blinking Hi-speed	64	16
IPM Error	6 times	5 times	Blinking Hi-speed	65	17
Discharge Thermistor Error	7 times	1 time	Blinking Hi-speed	71	18
Compressor Thermistor Error	7 times	2 times	Blinking Hi-speed	72	19
Heat Ex. Middle Temp. Thermistor Error	7 times	3 times	Blinking Hi-speed	73	20
Heat Ex. Liquid Temp. Thermistor Error	7 times	3 times	Blinking Hi-speed	73	21
Outdoor Thermistor Error	7 times	4 times	Blinking Hi-speed	74	22
Heat Sink Temp. Sensor Error	7 times	7 times	Blinking Hi-speed	77	23
Current Sensor Error	8 times	4 times	Blinking Hi-speed	84	24
Pressure Sensor Error	8 times	6 times	Blinking Hi-speed	86	25
Over Current Error	9 times	4 times	Blinking Hi-speed	94	26
Compressor Control Error	9 times	5 times	Blinking Hi-speed	95	27
Outdoor Unit Fan Motor 1 Error	9 times	7 times	Blinking Hi-speed	97	28
Outdoor Unit Fan Motor 2 Error	9 times	8 times	Blinking Hi-speed	98	29
4-Way Valve Error	9 times	9 times	Blinking Hi-speed	99	30
Discharge Temp. Error	10 times	1 time	Blinking Hi-speed	A1	31
Compressure Temp. Error	10 times	3 times	Blinking Hi-speed	A3	32
Low Pressure Error	10 times	5 times	Blinking Hi-speed	A5	33

2-1-2 WIRED REMOTE CONTROLLER DISPLAY

AR-WEC1E (2 wire remote controller)

1. Check the error

1. If an error occurs, an error icon appears on the "Monitor mode screen".
Touch the [Status] on the "Monitor mode screen". The "Status" screen is displayed.
2. Touch the [Error Information] on the "Status" screen. The "Error Information" screen is displayed.
(If there are no errors, the [Error Information] will not be displayed.)
3. 2-digit numbers correspond to the error code in the table below. Touch the [Next page] (or [Previous page]) to switch to other connected indoor units.

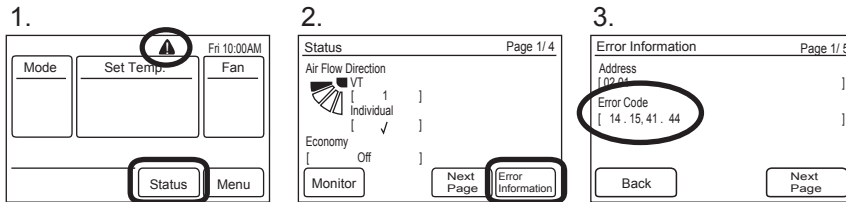

AR-WAE1U (3 wire remote controller)

1. SELF - DIAGNOSIS

When "Er" in Temperature Display is displayed, inspection of the air conditioning system is necessary. Please consult authorized service personnel.

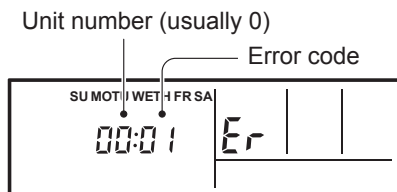

ex. Self-diagnosis check

2. ERROR CODE HISTORY DISPLAY

Up to 16 memorized error codes may be displayed for the indoor unit connected to the remote controller.

1. Stop the air conditioner operation.

2. Press the SET TEMPERATURE buttons ∇ , \blacktriangle simultaneously for 3 seconds or more to start the self-diagnosis.

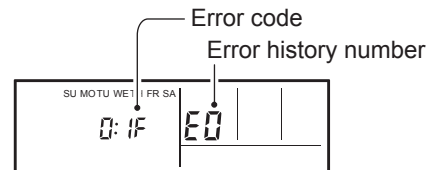
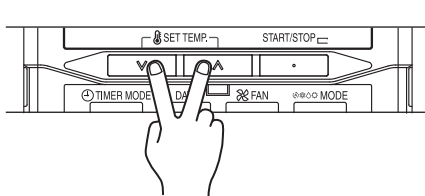

3. Press the SET TEMPERATURE button to select the error history number.

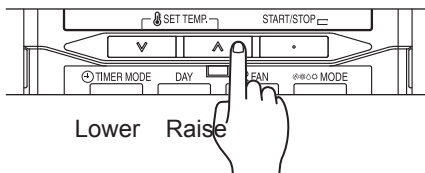

0 ↔ 1 ↔ 2 ↔ 3 ↔ 4 ↔ 5 ↔ 6 ↔ 7 ↔
F ↔ E ↔ d ↔ c ↔ b ↔ A ↔ 9 ↔ 8 ↔

4. Press the SET TEMPERATURE buttons ∇ , \blacktriangle simultaneously for 3 seconds or more or there is no key input for 60 seconds to stop the display.

2-1-3 OUTDOOR UNIT DISPLAY

You can determine the operating status by the lighting up and blinking of the LED lamp.

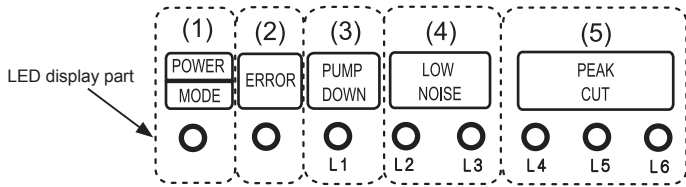

Display when an error occurs.

POWER/ MODE	ERROR	PUMP DOWN	LOW NOISE		PEAK CUT		
		(L1)	(L2)	(L3)	(L4)	(L5)	(L6)
●	Blink (Hi speed)	○	○	○	○	○	○

Sign "○": Lights off, "●": Lights on

(1) Check that the "ERROR" LED blinks, then press the "ENTER" button once.

(2) For details, refer to the following table.

Check that the "ERROR" LED blinks, then press the [Enter] button once.

For details, refer to the following table. ○ : Light OFF ● : Light ON ◆2 : 2Times Blinking ◆1 ~ ◆15 : 1~ 15 Times Blinking

Error Contents	LED DISPLAY								Trouble shooting
	POWER	ERROR	PUMP	LOW		PEAK			
	MODE		DOWN	NOISE	CUT				
			(L1)	(L2)	(L3)	(L4)	(L5)	(L6)	
Serial Communication Error	◆2	●	◆1	◆1	○	○	●	●	2
	◆2	●	◆1	◆1	○	●	○	○	
Indoor Unit Error	◆2	●	◆5	◆15	○	○	○	●	1, 3, 6 - 8 10 - 13
Outdoor unit main PCB model information error	◆2	●	◆6	◆2	○	○	○	●	14
Inverter Error	◆2	●	◆6	◆3	○	○	○	●	15
IPM Error	◆2	●	◆6	◆5	○	○	●	●	17
Discharge Thermistor Error	◆2	●	◆7	◆1	○	○	○	●	18
Compressor Thermistor Error	◆2	●	◆7	◆2	○	○	○	●	19
Heat Ex. middle temp. sensor Error	◆2	●	◆7	◆3	○	○	●	○	20
Heat Ex. liquid temp. sensor Error	◆2	●	◆7	◆3	○	○	●	●	21
Outdoor Thermistor Error	◆2	●	◆7	◆4	○	○	○	●	22
Heat Sink Temp. Sensor Error	◆2	●	◆7	◆7	○	○	○	●	23
Current sensor Error	◆2	●	◆8	◆4	○	○	○	●	24
Pressure sensor Error	◆2	●	◆8	◆6	○	●	●	○	25
Trip detection Error	◆2	●	◆9	◆4	○	○	○	●	26
Compressor Control Error	◆2	●	◆9	◆5	○	○	○	●	27
Outdoor Unit Fan Motor 1 Error	◆2	●	◆9	◆7	○	○	●	●	28
Outdoor Unit Fan Motor 2 Error	◆2	●	◆9	◆8	○	○	●	●	29
4-way Valve Error	◆2	●	◆9	◆9	○	○	○	●	30
Discharge Temp. Error	◆2	●	◆10	◆1	○	○	○	●	31
Compressor Temp. Error	◆2	●	◆10	◆3	○	○	○	●	32
Low Pressure Error	◆2	●	◆10	◆5	○	○	○	●	33

2-2 TROUBLE SHOOTING WITH ERROR CODE

<p>Trouble shooting 1 OUTDOOR UNIT Error Method: Serial Communication Error (Serial Reverse Transfer Error)</p>	<p>Indicate of Display:</p> <p>Indoor Unit : Operation lamp : 1 times Flash, Timer lamp : 1 times Flash ERROR CODE : [E : 11]</p> <p style="text-align: right;">Outdoor unit : No indication</p>
--	---

<p>Detective Actuators:</p> <p>Outdoor unit main PCB Outdoor unit fan motor</p>	<p>Detective details:</p> <p>When the indoor unit cannot receive the serial signal from outdoor unit more than 2 minutes after power ON, or the indoor unit cannot receive the serial signal more than 15 seconds during normal operation.</p>
---	---

<p>Forecast of Cause:</p> <p>1. Connection failure 2. External cause 3. Main PCB failure 4. Active filter module failure 5. Transistor PCB (IPM) failure 6. Filter PCB failure 7. Outdoor unit Fan motor failure</p>
--

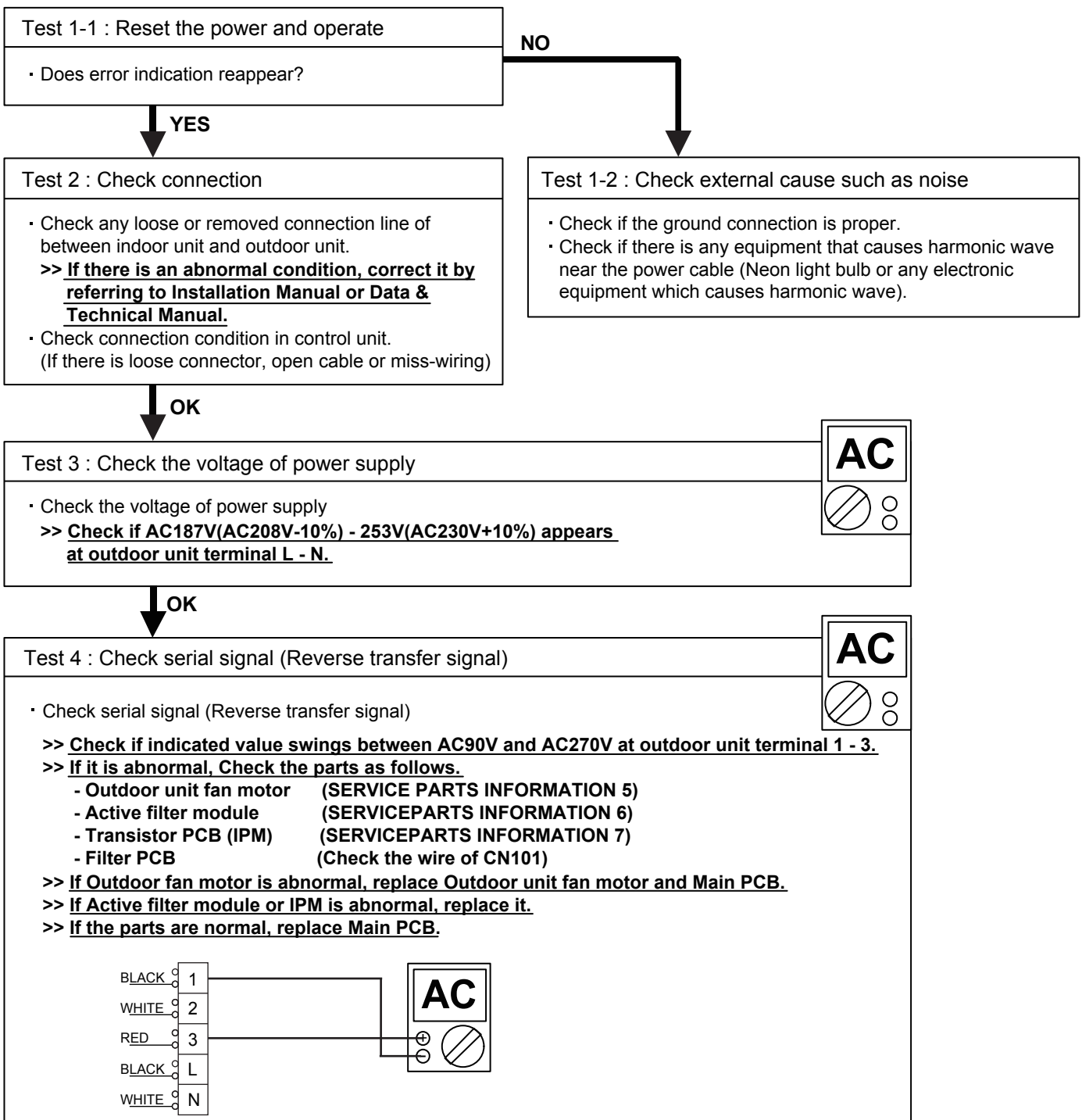

<p>Trouble shooting 2 INDOOR UNIT Error Method: Serial Communication Error (Serial Forward Transfer Error)</p>	<p>Indicate of Display: Indoor Unit : Operation lamp: 1 times Flash, Timer lamp : 1 times Flash ERROR CODE : [E : 11]</p>	<p>Outdoor unit :</p> <table border="1" style="width: 100%; border-collapse: collapse; text-align: center;"> <thead> <tr> <th>POWER</th> <th>ERROR</th> <th>PUMP DOWN</th> <th colspan="3">LOW NOISE</th> <th colspan="3">PEAK CUT</th> </tr> <tr> <th>MODE</th> <th></th> <th>(L1)</th> <th>(L2)</th> <th>(L3)</th> <th>(L4)</th> <th>(L5)</th> <th>(L6)</th> </tr> </thead> <tbody> <tr> <td>◆2</td> <td>●</td> <td>◆1</td> <td>◆1</td> <td>○</td> <td>○</td> <td>●</td> <td>●</td> </tr> <tr> <td>◆2</td> <td>●</td> <td>◆1</td> <td>◆1</td> <td>○</td> <td>●</td> <td>○</td> <td>○</td> </tr> </tbody> </table> <p>○: Light OFF ●: Light ON ◆n: n times blinking</p>	POWER	ERROR	PUMP DOWN	LOW NOISE			PEAK CUT			MODE		(L1)	(L2)	(L3)	(L4)	(L5)	(L6)	◆2	●	◆1	◆1	○	○	●	●	◆2	●	◆1	◆1	○	●	○	○
POWER	ERROR	PUMP DOWN	LOW NOISE			PEAK CUT																													
MODE		(L1)	(L2)	(L3)	(L4)	(L5)	(L6)																												
◆2	●	◆1	◆1	○	○	●	●																												
◆2	●	◆1	◆1	○	●	○	○																												

<p>Detective Actuators: Indoor unit controller PCB</p>	<p>Detective details: When the indoor unit cannot properly receive the serial signal from indoor unit for 10 seconds or more.</p>
--	---

Forecast of Cause:
 1. Connection failure 2. External cause 3. Controller PCB failure

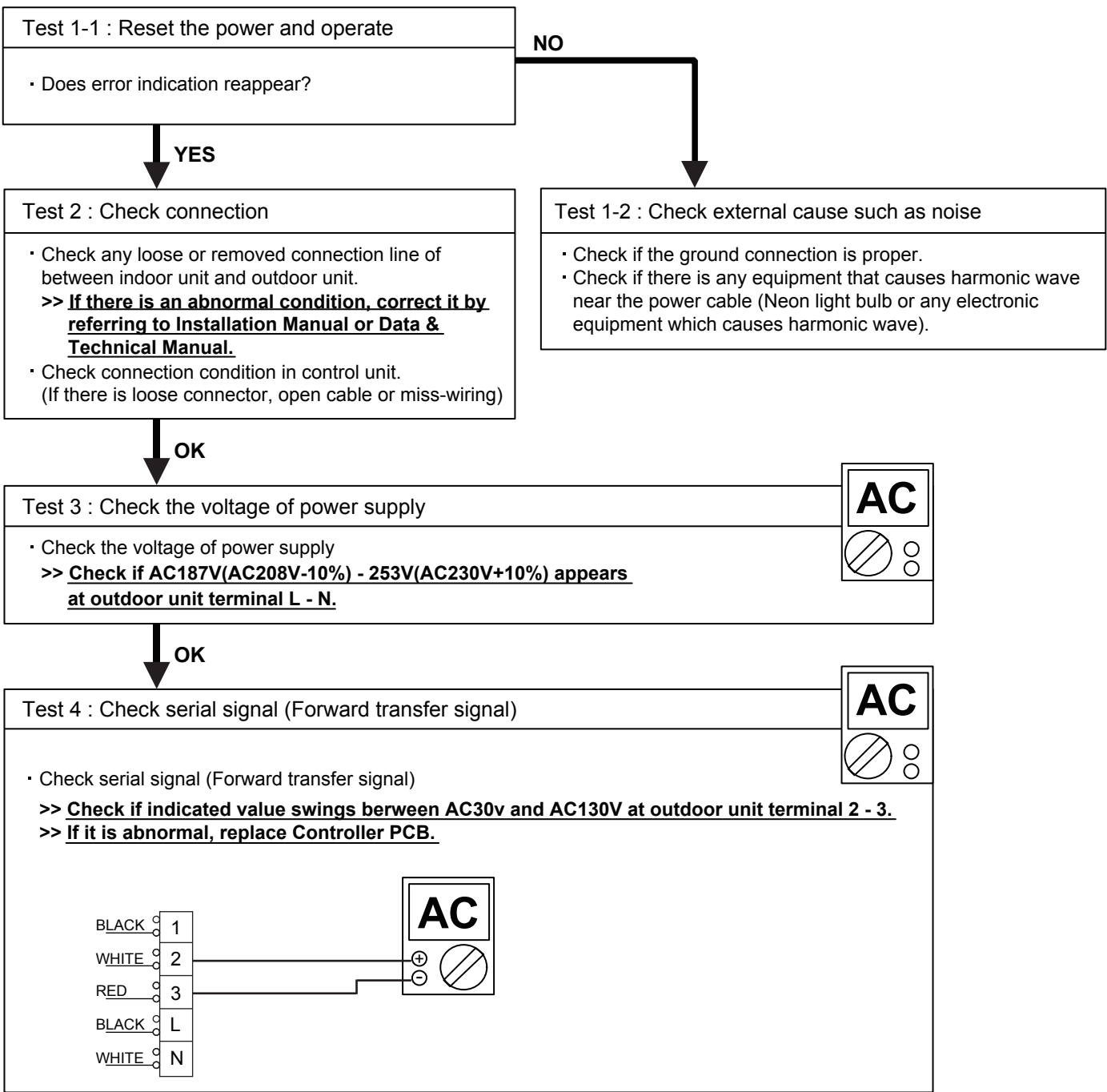

<p>Trouble shooting 3 INDOOR UNIT Error Method: Wired Remote Controller Communication Error</p>	<p>Indicate of Display: Indoor Unit : Operation lamp: 1 times Flash, Timer lamp : 2 times Flash ERROR CODE : [E : 12]</p>	<p>Outdoor unit :</p> <table border="1" style="width: 100%; border-collapse: collapse; text-align: center;"> <tr> <th>POWER</th> <th>ERROR</th> <th>PUMP DOWN</th> <th colspan="3">LOW NOISE</th> <th colspan="2">PEAK CUT</th> </tr> <tr> <td>MODE</td> <td></td> <td>(L1)</td> <td>(L2)</td> <td>(L3)</td> <td>(L4)</td> <td>(L5)</td> <td>(L6)</td> </tr> <tr> <td>◆2</td> <td>●</td> <td>◆5</td> <td>◆15</td> <td>○</td> <td>○</td> <td>○</td> <td>●</td> </tr> </table> <p>○ : Light OFF ● : Light ON ◆n : n times blinking</p>	POWER	ERROR	PUMP DOWN	LOW NOISE			PEAK CUT		MODE		(L1)	(L2)	(L3)	(L4)	(L5)	(L6)	◆2	●	◆5	◆15	○	○	○	●
POWER	ERROR	PUMP DOWN	LOW NOISE			PEAK CUT																				
MODE		(L1)	(L2)	(L3)	(L4)	(L5)	(L6)																			
◆2	●	◆5	◆15	○	○	○	●																			

<p>Detective Actuators: Indoor unit controller PCB Wired remote controller</p>	<p>Detective details: When the indoor unit cannot properly receive the signal from wired remote controller for 1 minutes or more.</p>
---	---

Forecast of Cause:
1. Connection failure 2. Wired Remote Controller failure 3. Controller PCB failure

Test 1 : Check the connection of terminal

Check & correct the followings.
• Check the connection of terminal between Wired Remote Controller and indoor unit, and check if there is a disconnection of the cable.



<p>Test 2 : Check Wired Remote Controller and Controller PCB</p> <p>• Ceck Voltage at CN12 of Controller PCB. (terminal 1-2) (Power supply to Remote Control)</p> <p>>> If it is DC12V, Remote Control is failure. (Controller PCB is normal) >> Replace Remote Control >> If it is DC 0V, Controller PCB is failure. (Check Remote Control once again) >> Replace Controller PCB</p>	<div style="border: 1px solid black; padding: 5px; width: 40px; margin: 0 auto;"> <p style="margin: 0;">DC</p>  </div>
---	--

Trouble shooting 4 INDOOR UNIT Error Method: External communication error	Indicate or Display: Indoor Unit : Operation lamp: 1 times Flash, Timer lamp : 8 times Flash ERROR CODE : [E : 18]	Outdoor unit :																											
		<table border="1"> <tr> <td>POWER</td> <td>ERROR</td> <td>PUMP DOWN</td> <td colspan="2">LOW NOISE</td> <td colspan="2">PEAK CUT</td> </tr> <tr> <td>MODE</td> <td></td> <td>(L1)</td> <td>(L2)</td> <td>(L3)</td> <td>(L4)</td> <td>(L5)</td> <td>(L6)</td> </tr> <tr> <td>◆2</td> <td>●</td> <td>◆5</td> <td>◆15</td> <td>○</td> <td>○</td> <td>○</td> <td>●</td> </tr> </table>	POWER	ERROR	PUMP DOWN	LOW NOISE		PEAK CUT		MODE		(L1)	(L2)	(L3)	(L4)	(L5)	(L6)	◆2	●	◆5	◆15	○	○	○	●	O : Light OFF ● : Light ON ◆n : n times blinking			
POWER	ERROR	PUMP DOWN	LOW NOISE		PEAK CUT																								
MODE		(L1)	(L2)	(L3)	(L4)	(L5)	(L6)																						
◆2	●	◆5	◆15	○	○	○	●																						

Detective Actuators: External communication error	Detective details: After receiving a signal from the external I/O PCB, the same a signal has not been received for 15sec
---	---

Forecast of Cause : 1. Connection failure 2.External I/O PCB failure 3.Controller PCB failure

Check Point 1 : Check the connection
<ul style="list-style-type: none"> ▪ Check any loose or removed connection of between the controller PCB to the external I/O PCB >>If there is an abnormal condition, correct it by refer to installation manual or the technical manual. ▪ Check the connection condition on the external I/O PCB and the controller PCB (If there is loose connector, open cable or mis-wiring)



Check Point 2: Replace external I/O PCB
▶ <u>If Check Point 1 do not improve the symptom, change External I/O PCB.</u>



Check Point 3: Replace Controller PCB
▶ <u>If Check Point 2 do not improve the symptom, change Controller PCB.</u>

<p>Trouble shooting 5 <u>OUTDOOR UNIT Error Method:</u> Combination Error</p>	<p><u>Indicate or Display:</u> Indoor Unit : Operation lamp: 2 times Flash, Timer lamp : 3 times Flash ERROR CODE : [E : 23]</p> <p style="text-align: right;">Outdoor unit : No indication</p>
--	---

<p><u>Detective Actuators:</u> Indoor unit</p>	<p><u>Detective details:</u> 1. The outdoor unit receives the serial signal of applied refrigerant information from Indoor unit. When the refrigerant is R410a. 2. When the outdoor unit type is multi.</p>
--	--

<p><u>Forecast of Cause:</u> 1. The selection of indoor units is incorrect</p>
--

<p>Check Point 1 : Check the type of indoor unit</p>
<p>• Check the type of the connected indoor unit. >> <u>If abnormal condition is found, correct it.</u></p>



<p>Check Point 2 : Replace Main PCB</p>
<p>▶ <u>If Check Point 1 do not improve the symptom, replace Main PCB of Outdoor unit.</u></p>

<p>Trouble shooting 6 OUTDOOR UNIT Error Method: Address setting Error in Wired remote controller system</p>	<p>Indicate or Display: Indoor Unit : Operation lamp: 2 times Flash, Timer lamp : 6 times Flash ERROR CODE : [E : 26]</p>	<p>Outdoor unit :</p> <table border="1" style="width: 100%; border-collapse: collapse; text-align: center;"> <tr> <th>POWER</th> <th>ERROR</th> <th>PUMP DOWN</th> <th colspan="3">LOW NOISE</th> <th colspan="3">PEAK CUT</th> </tr> <tr> <td>MODE</td> <td></td> <td>(L1)</td> <td>(L2)</td> <td>(L3)</td> <td>(L4)</td> <td>(L5)</td> <td>(L6)</td> </tr> <tr> <td>◆2</td> <td>●</td> <td>◆5</td> <td>◆15</td> <td>○</td> <td>○</td> <td>○</td> <td>●</td> </tr> </table> <p>○: Light OFF ●: Light ON ◆n: n times blinking</p>	POWER	ERROR	PUMP DOWN	LOW NOISE			PEAK CUT			MODE		(L1)	(L2)	(L3)	(L4)	(L5)	(L6)	◆2	●	◆5	◆15	○	○	○	●
POWER	ERROR	PUMP DOWN	LOW NOISE			PEAK CUT																					
MODE		(L1)	(L2)	(L3)	(L4)	(L5)	(L6)																				
◆2	●	◆5	◆15	○	○	○	●																				

<p>Detective Actuators: Wired remote controller (2-Wire) Indoor unit Controller PCB circuit</p>	<p>Detective details: When the address number set by auto setting and manual setting are mixed in one RC group. When the duplicated address number exists in one RC group.</p>
--	---

Forecast of Cause : 1. Wrong wiring of RCgroup 2. Wrong remote address setting 3. Indoor unit controller PCB failure
4. Remote controller failure

<p>Check Point 1 :Wire installation</p>
<p><input type="checkbox"/> Wrong wire connection in RCgroup (Please refer to the installation manual)</p>



<p>Check Point 2 : Wrong RCgroup setting</p>
<p><input type="checkbox"/> The given address number by auto setting (00) and the manual set number (Except 00) were not existing in one RCG. <input type="checkbox"/> The remote controller address setting by U.I. were not existing same address. <input type="checkbox"/> The duplicated address number is not existing in one RCgroup</p>



<p>Check Point 3 : Check Indoor unit controller PCB</p>
<p><input type="checkbox"/> Check if controller PCB damage <input type="checkbox"/> Change controller PCB and check the Error after setting remote controller address</p>

<p>Trouble shooting 7 INDOOR UNIT Error Method: Connection unit number error (Indoor unit in Wired remote controller system)</p>	<p>Indicate or Display: Indoor Unit : Operation lamp: 2 times Flash, Timer lamp : 9 times Flash ERROR CODE : [E : 29]</p>	<p>Outdoor unit :</p> <table border="1" data-bbox="1034 212 1450 313"> <thead> <tr> <th>POWER</th> <th>ERROR</th> <th>PUMP DOWN</th> <th colspan="3">LOW NOISE</th> <th colspan="3">PEAK CUT</th> </tr> <tr> <th>MODE</th> <th></th> <th>(L1)</th> <th>(L2)</th> <th>(L3)</th> <th>(L4)</th> <th>(L5)</th> <th>(L6)</th> </tr> </thead> <tbody> <tr> <td>◆2</td> <td>●</td> <td>◆5</td> <td>◆15</td> <td>○</td> <td>○</td> <td>○</td> <td>●</td> </tr> </tbody> </table> <p>○: Light OFF ●: Light ON ◆n: n times blinking</p>	POWER	ERROR	PUMP DOWN	LOW NOISE			PEAK CUT			MODE		(L1)	(L2)	(L3)	(L4)	(L5)	(L6)	◆2	●	◆5	◆15	○	○	○	●
POWER	ERROR	PUMP DOWN	LOW NOISE			PEAK CUT																					
MODE		(L1)	(L2)	(L3)	(L4)	(L5)	(L6)																				
◆2	●	◆5	◆15	○	○	○	●																				

<p>Detective Actuators: Wired remote controller (2-Wire) Indoor unit Controller PCB circuit</p>	<p>Detective details: When the number of connecting indoor units are out of specified rule.</p>
--	---

Forecast of Cause : 1. Wrong wiring / Number of I.U, RC in RCgroup 2. Indoor unit controller PCB defective

Check Point 1 : Wire installation

- Wrong number of connecting indoor unit



Check Point 2 : Check Indoor unit controller PCB

- Check if controller PCB damage
- Check if controller PCB and check the Error after setting remote controller address

<p>Trouble shooting 8 INDOOR UNIT Error Method: Indoor Unit PCB Model Information Error</p>	<p>Indicate of Display: Indoor Unit : Operation lamp: 3 times Flash, Timer lamp : 2 times Flash ERROR CODE : [E : 32]</p>	<p>Outdoor unit :</p> <table border="1" style="width: 100%; border-collapse: collapse; text-align: center;"> <tr> <td>POWER</td> <td>ERROR</td> <td>PUMP DOWN</td> <td colspan="3">LOW NOISE</td> <td colspan="3">PEAK CUT</td> </tr> <tr> <td>MODE</td> <td></td> <td>(L1)</td> <td>(L2)</td> <td>(L3)</td> <td>(L4)</td> <td>(L5)</td> <td>(L6)</td> </tr> <tr> <td>◆2</td> <td>●</td> <td>◆5</td> <td>◆15</td> <td>○</td> <td>○</td> <td>○</td> <td>●</td> </tr> </table> <p>○: Light OFF ●: Light ON ◆n: n times blinking</p>	POWER	ERROR	PUMP DOWN	LOW NOISE			PEAK CUT			MODE		(L1)	(L2)	(L3)	(L4)	(L5)	(L6)	◆2	●	◆5	◆15	○	○	○	●
POWER	ERROR	PUMP DOWN	LOW NOISE			PEAK CUT																					
MODE		(L1)	(L2)	(L3)	(L4)	(L5)	(L6)																				
◆2	●	◆5	◆15	○	○	○	●																				

<p>Detective Actuators: Indoor unit controller PCB</p>	<p>Detective details: When power is on and there is some below case. 1. When model information of EEPROM is incorrect. 2. When the access to EEPROM failed.</p>
--	---

Forecast of Cause:
 1. External cause 2. Defective connection of electric components 3. Controller PCB failure

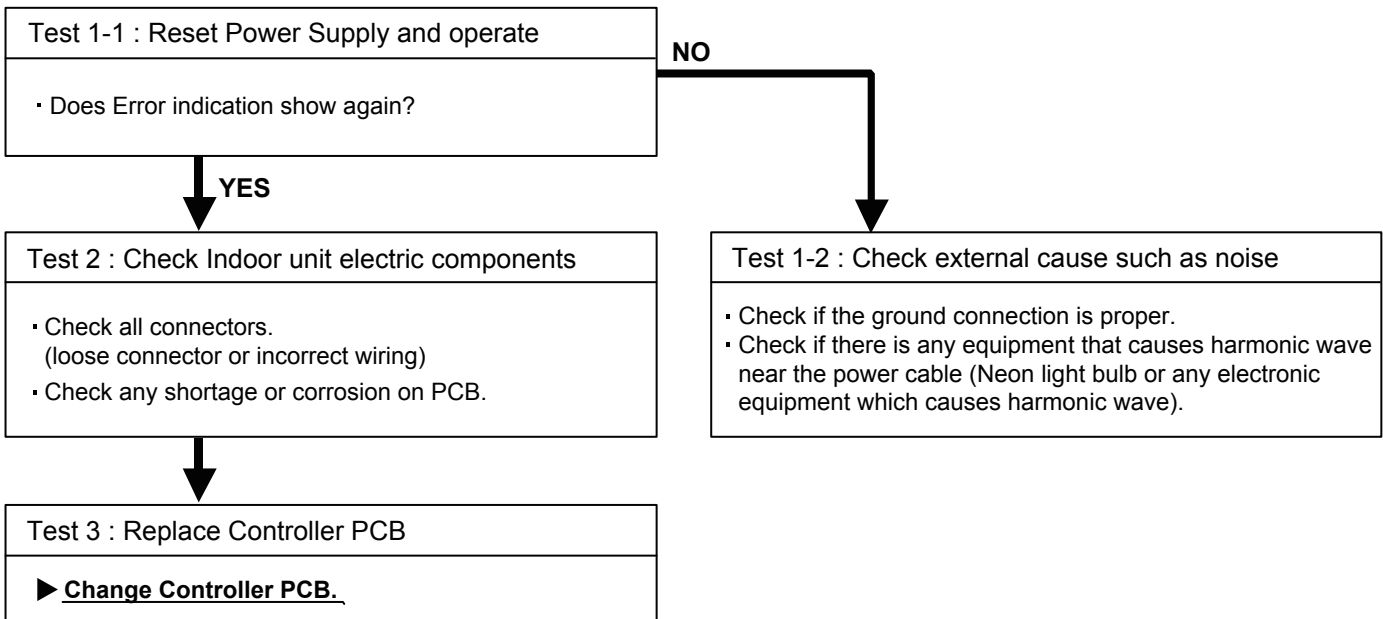



Note : EEPROM

EEPROM(Electronically Erasable and Programmable Read Only Memory) is a non-volatile memory which keeps memorized information even if power is turned off. It can change the contents electronically. To change the contents, it uses higher voltage than normal, and it can not change a partial contents. (Rewriting shall be done upon erasing the all contents.) There is a limit in a number of rewriting.

Trouble shooting 9 INDOOR UNIT Error Method: Manual Auto Switch Error	Indicate of Display: Indoor Unit : Operation lamp: 3 times Flash, Timer lamp : 5 times Flash ERROR CODE : [E : 35]	Outdoor unit : <table border="1" style="width: 100%; border-collapse: collapse; text-align: center;"> <tr> <td>POWER</td> <td>ERROR</td> <td>PUMP DOWN</td> <td colspan="2">LOW NOISE</td> <td colspan="2">PEAK CUT</td> </tr> <tr> <td>MODE</td> <td></td> <td>(L1)</td> <td>(L2)</td> <td>(L3)</td> <td>(L4)</td> <td>(L5) (L6)</td> </tr> <tr> <td>◆2</td> <td>●</td> <td>◆5</td> <td>◆15</td> <td>○</td> <td>○</td> <td>○ ●</td> </tr> </table> <p style="font-size: small;">○ : Light OFF ● : Light ON ◆n : n times blinking</p>	POWER	ERROR	PUMP DOWN	LOW NOISE		PEAK CUT		MODE		(L1)	(L2)	(L3)	(L4)	(L5) (L6)	◆2	●	◆5	◆15	○	○	○ ●
POWER	ERROR	PUMP DOWN	LOW NOISE		PEAK CUT																		
MODE		(L1)	(L2)	(L3)	(L4)	(L5) (L6)																	
◆2	●	◆5	◆15	○	○	○ ●																	

Detective Actuators: Indoor unit controller PCB Indicator PCB Manual auto switch	Detective details: When the Manual Auto Switch becomes ON for consecutive 60 or more seconds.
--	---

Forecast of Cause:
 1. Manual auto switch failure 2. Controller PCB and Indicator PCB failure

Test 1 : Check the Manual auto switch	
<ul style="list-style-type: none"> • Check if Manual auto switch is kept pressed. • Check ON/OFF switching operation by using a meter. <p>>> <u>If Manual auto switch is disabled (on/off switching), replace it.</u></p>	
<div style="display: flex; align-items: center; justify-content: center;"> <div style="font-size: 2em; margin-right: 5px;">↓</div> <div style="text-align: left; margin-right: 10px;">OK</div> </div>	
Test 2 : Replace Controller PCB and Indicator PCB	
<p>▶ <u>If Test 1 do not improve the symptom, replace Controller PCB and Indicator PCB.</u></p>	

Trouble shooting 10 INDOOR UNIT Error Method: Indoor unit communication circuit (WRC) error	Indicate or Display: Indoor Unit : Operation lamp: 3 timesFlash, Timer lamp : 10times Flash Error Code : 3 A	Outdoor unit :																											
		<table border="1"> <tr> <td>POWER</td> <td>ERROR</td> <td>PUMP DOWN</td> <td colspan="2">LOW NOISE</td> <td colspan="2">PEAK CUT</td> </tr> <tr> <td>MODE</td> <td></td> <td>(L1)</td> <td>(L2)</td> <td>(L3)</td> <td>(L4)</td> <td>(L5)</td> <td>(L6)</td> </tr> <tr> <td>◆2</td> <td>●</td> <td>◆5</td> <td>◆15</td> <td>○</td> <td>○</td> <td>○</td> <td>●</td> </tr> </table>	POWER	ERROR	PUMP DOWN	LOW NOISE		PEAK CUT		MODE		(L1)	(L2)	(L3)	(L4)	(L5)	(L6)	◆2	●	◆5	◆15	○	○	○	●				
POWER	ERROR	PUMP DOWN	LOW NOISE		PEAK CUT																								
MODE		(L1)	(L2)	(L3)	(L4)	(L5)	(L6)																						
◆2	●	◆5	◆15	○	○	○	●																						

Detective Actuators: Wired remote controller (2-Wire) Indoor unit Controller PCB circuit	Detective details: When the indoor unit(s) detects the configuration of RCG abnormal or the indoor unit detects lack of primary -remote controller.
---	---

Forecast of Cause : 1. Terminal connection abnormal 2. Wired remote controller failure
 3. Indoor unit controller PCB defective

Check Point 1 : Check the connection of terminal

After turning off the power supply, check & correct the followings

- Indoor unit - Check the connection of terminal between remote control and indoor unit, or between Indoor units and check if there is a disconnection or short of the cable



Check Point 2 , 3: Check Indoor unit controller PCB

- Check terminal voltage of controller PCB connector CNC01 (Power supply for remote)
 If DC12V, Remote control failure (Controller PCB is OK) >>> Replace Remote controller
 If DC0V, Controller PCB failure (Remote is OK) >>> Replace Controller PCB

In case of re-installation is done due to removed connector or incorrect wiring, turn on the power again.

Trouble shooting 11 INDOOR UNIT Error Method: Indoor Room Thermistor Error	Indicate of Display: Indoor Unit : Operation lamp: 4 times Flash, Timer lamp : 1 times Flash ERROR CODE : [E : 41]	Outdoor unit : <table border="1" style="width: 100%; border-collapse: collapse; text-align: center;"> <tr> <td>POWER</td> <td>ERROR</td> <td>PUMP DOWN</td> <td colspan="3">LOW NOISE</td> <td colspan="3">PEAK CUT</td> </tr> <tr> <td>MODE</td> <td></td> <td>(L1)</td> <td>(L2)</td> <td>(L3)</td> <td>(L4)</td> <td>(L5)</td> <td>(L6)</td> <td></td> </tr> <tr> <td>◆2</td> <td>●</td> <td>◆5</td> <td>◆15</td> <td>○</td> <td>○</td> <td>○</td> <td>○</td> <td>●</td> </tr> </table> <p>○: Light OFF ●: Light ON ◆n: n times blinking</p>	POWER	ERROR	PUMP DOWN	LOW NOISE			PEAK CUT			MODE		(L1)	(L2)	(L3)	(L4)	(L5)	(L6)		◆2	●	◆5	◆15	○	○	○	○	●
POWER	ERROR	PUMP DOWN	LOW NOISE			PEAK CUT																							
MODE		(L1)	(L2)	(L3)	(L4)	(L5)	(L6)																						
◆2	●	◆5	◆15	○	○	○	○	●																					

Detective Actuators: Indoor unit controller PCB circuit Indoor temperature thermistor	Detective details: Room temperature thermistor is open or short is detected always.
--	---

Forecast of Cause:
 1. Connector failure connection 2. Thermistor failure 3. Controller PCB failure

Test 1 : Check connection of Connector

- Check if connector is loose or removed
- Check erroneous connection
- Check if thermistor cable is open

>>Reset Power when reinstalling due to removed connector or incorrect wiring.



Test 2 : Remove connector and check Thermistor resistance value

Thermistor Characteristics(Rough value)

Temperature (°C)	-10	0	10	20	30	40	45
Temperature (°F)	14	32	50	68	86	104	113
Resistance value (kΩ)	58.25	33.62	20.17	12.54	8.04	5.30	4.35

► **If Thermistor is either open or shorted, replace it and reset the power.**



Test 3 : Check Voltage of Controller PCB (DC 5.0V)

Make sure circuit diagram of each indoor unit and check terminal voltage at Thermistor (DC5.0V)

CN1	1	1	BLACK		Pipe Temp. Thermistor
	2	2	BLACK		
	3	3	BLACK		Room Temp. Thermistor
	4	4	BLACK		

► **If the voltage does not appear, replace Controller PCB and execute the check operation again.**

Trouble shooting 12 INDOOR UNIT Error Method: Indoor Heat Ex. Thermistor Error	Indicate of Display: Indoor Unit : Operation lamp: 4 times Flash, Timer lamp : 2 times Flash ERROR CODE : [E : 42]	Outdoor unit : <table border="1" style="width: 100%; border-collapse: collapse; text-align: center;"> <tr> <td>POWER</td> <td>ERROR</td> <td>PUMP DOWN</td> <td colspan="3">LOW NOISE</td> <td colspan="3">PEAK CUT</td> </tr> <tr> <td>MODE</td> <td></td> <td>(L1)</td> <td>(L2)</td> <td>(L3)</td> <td>(L4)</td> <td>(L5)</td> <td>(L6)</td> <td></td> </tr> <tr> <td>◆2</td> <td>●</td> <td>◆5</td> <td>◆15</td> <td>○</td> <td>○</td> <td>○</td> <td>○</td> <td>●</td> </tr> </table> <p style="font-size: small;">○: Light OFF ●: Light ON ◆n: n times blinking</p>	POWER	ERROR	PUMP DOWN	LOW NOISE			PEAK CUT			MODE		(L1)	(L2)	(L3)	(L4)	(L5)	(L6)		◆2	●	◆5	◆15	○	○	○	○	●
POWER	ERROR	PUMP DOWN	LOW NOISE			PEAK CUT																							
MODE		(L1)	(L2)	(L3)	(L4)	(L5)	(L6)																						
◆2	●	◆5	◆15	○	○	○	○	●																					

Detective Actuators: Indoor unit controller PCB circuit Heat exchanger thermistor	Detective details: Heat exchanger temperature thermistor is open or short is detected always.
--	---

Forecast of Cause:
 1. Connector failure connection 2. Thermistor failure 3. Controller PCB failure

Test 1 : Check connection of Connector

- Check if connector is loose or removed
- Check erroneous connection
- Check if thermistor cable is open

>>Reset Power when reinstalling due to removed connector or incorrect wiring.



Test 2 : Remove connector and check Thermistor resistance value									
Thermistor Characteristics(Rough value)									
Temperature (°C)	-30	-20	-10	0	10	20	30	40	50
Temperature (°F)	-22	-4	14	32	50	68	86	104	122
Resistance value (kΩ)	1131.91	579.59	312.27	176.03	103.34	62.91	39.57	25.64	17.06

Temperature (°C)	60	65
Temperature (°F)	140	149
Resistance value (kΩ)	11.64	9.69

▶ If Thermistor is either open or shorted, replace it and reset the power.

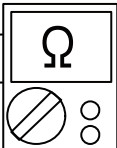

Test 3 : Check Voltage of Controller PCB (DC 5.0V)	DC
Make sure circuit diagram of each indoor unit and check terminal voltage at Thermistor (DC5.0V)	
▶ If the voltage does not appear, replace Controller PCB and execute the check operation again.	



Trouble shooting 13 INDOOR UNIT Error Method: Indoor Unit Fan Motor Error	Indicate of Display: Indoor Unit : Operation lamp: 5 times Flash, Timer lamp : 1 times Flash ERROR CODE : [E : 51]	Outdoor unit : <table border="1" style="width: 100%; border-collapse: collapse; text-align: center;"> <tr> <td>POWER</td> <td>ERROR</td> <td>PUMP DOWN</td> <td colspan="3">LOW NOISE</td> <td colspan="2">PEAK CUT</td> </tr> <tr> <td>MODE</td> <td></td> <td>(L1)</td> <td>(L2)</td> <td>(L3)</td> <td>(L4)</td> <td>(L5)</td> <td>(L6)</td> </tr> <tr> <td>◆2</td> <td>●</td> <td>◆5</td> <td>◆15</td> <td>○</td> <td>○</td> <td>○</td> <td>●</td> </tr> </table> <p style="font-size: small;">○: Light OFF ●: Light ON ◆n: n times blinking</p>	POWER	ERROR	PUMP DOWN	LOW NOISE			PEAK CUT		MODE		(L1)	(L2)	(L3)	(L4)	(L5)	(L6)	◆2	●	◆5	◆15	○	○	○	●
POWER	ERROR	PUMP DOWN	LOW NOISE			PEAK CUT																				
MODE		(L1)	(L2)	(L3)	(L4)	(L5)	(L6)																			
◆2	●	◆5	◆15	○	○	○	●																			

Detective Actuators: Indoor unit power supply PCB Indoor unit fan motor	Detective details: When the fan motor speed is less than 1/3 of the target fan speed for 56 seconds. When detect the 0 rpm for 56 seconds after fan motor started.
--	---

Forecast of Cause:

1. Fan rotation failure 2. Fan motor winding open 3. Motor protection by surrounding temperature rise
 4. Power Supply PCB failure 5. Indoor unit fan motor failure

Test 1 : Check rotation of Fan

• Rotate the fan by hand when operation is off.
 (Check if fan is caught, dropped off or locked motor)
>>If Fan or Bearing is abnormal, replace It.



Test 2 : Check ambient temp. around motor

• Check excessively high temperature around the motor.
 (if there is any surrounding equipment that causes heat)
>>Upon the temperature coming down, restart operation.



Test 3 : Check Indoor unit fan motor

• Check Indoor unit fan motor. **(SERVICE PARTS INFORMATION 4)**
>>if Indoor unit fan motor is abnormal, replace Indoor unit fan motor.



Test 4 : Replace Power Supply PCB

▶ **If Test 1- 3 do not improve the symptom, replace Power Supply PCB.**

Trouble shooting 14 OUTDOOR UNIT Error Method: Outdoor Unit Main PCB Model Information Error	Indicate of Display: Indoor Unit : Operation lamp: 6 times Flash, Timer lamp : 2 times Flash ERROR CODE : [E : 62]	Outdoor unit : <table border="1"> <thead> <tr> <th>POWER</th> <th>ERROR</th> <th>PUMP DOWN</th> <th colspan="3">LOW NOISE</th> <th colspan="3">PEAK CUT</th> </tr> <tr> <th>MODE</th> <th></th> <th>(L1)</th> <th>(L2)</th> <th>(L3)</th> <th>(L4)</th> <th>(L5)</th> <th>(L6)</th> </tr> </thead> <tbody> <tr> <td>◆2</td> <td>●</td> <td>◆6</td> <td>◆2</td> <td>○</td> <td>○</td> <td>○</td> <td>●</td> </tr> </tbody> </table>	POWER	ERROR	PUMP DOWN	LOW NOISE			PEAK CUT			MODE		(L1)	(L2)	(L3)	(L4)	(L5)	(L6)	◆2	●	◆6	◆2	○	○	○	●
	POWER	ERROR	PUMP DOWN	LOW NOISE			PEAK CUT																				
MODE		(L1)	(L2)	(L3)	(L4)	(L5)	(L6)																				
◆2	●	◆6	◆2	○	○	○	●																				
○: Light OFF ●: Light ON ◆n: n times blinking																											

Detective Actuators: Outdoor unit main PCB	Detective details: When power is on and there is some below case. 1. When model information of EEPROM is incorrect. 2. When the access to EEPROM failed.
--	--

Forecast of Cause:
 1. External cause (Noise, temporary open, voltage drop) 2. Main PCB failure

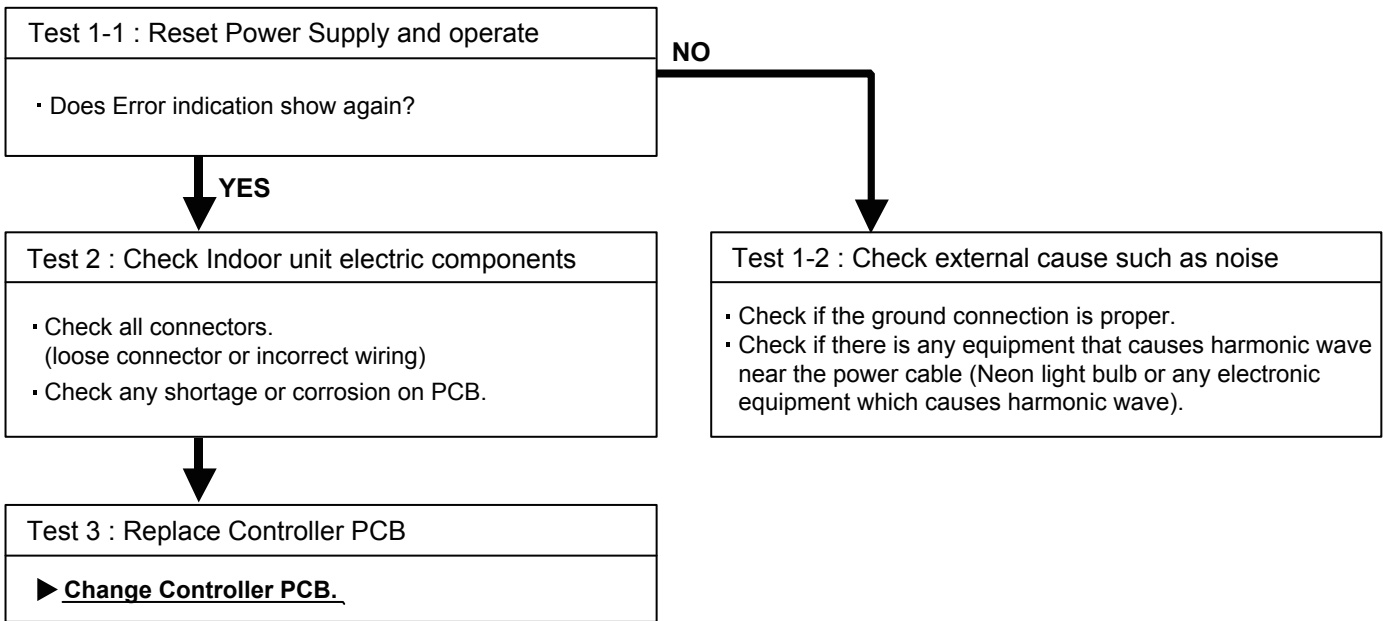

Note : EEPROM
 EEPROM(Electronically Erasable and Programmable Read Only Memory) is a non-volatile memory which keeps memorized information even if power is turned off. It can change the contents electronically. To change the contents, it uses higher voltage than normal, and it can not change a partial contents. (Rewriting shall be done upon erasing the all contents.) There is a limit in a number of rewriting.

Trouble shooting 15 OUTDOOR UNIT Error Method: Inverter Error	Indicate of Display: Indoor Unit : Operation lamp: 6 times Flash, Timer lamp : 3 times Flash ERROR CODE : [E : 63]	Outdoor unit : <table border="1" style="width: 100%; border-collapse: collapse; text-align: center;"> <thead> <tr> <th>POWER</th> <th>ERROR</th> <th>PUMP DOWN</th> <th colspan="3">LOW NOISE</th> <th colspan="2">PEAK CUT</th> </tr> <tr> <th>MODE</th> <th></th> <th>(L1)</th> <th>(L2)</th> <th>(L3)</th> <th>(L4)</th> <th>(L5)</th> <th>(L6)</th> </tr> </thead> <tbody> <tr> <td>◆2</td> <td>●</td> <td>◆6</td> <td>◆3</td> <td>○</td> <td>○</td> <td>○</td> <td>●</td> </tr> </tbody> </table> <p style="font-size: small;">○: Light OFF ●: Light ON ◆n: n times blinking</p>	POWER	ERROR	PUMP DOWN	LOW NOISE			PEAK CUT		MODE		(L1)	(L2)	(L3)	(L4)	(L5)	(L6)	◆2	●	◆6	◆3	○	○	○	●
POWER	ERROR	PUMP DOWN	LOW NOISE			PEAK CUT																				
MODE		(L1)	(L2)	(L3)	(L4)	(L5)	(L6)																			
◆2	●	◆6	◆3	○	○	○	●																			

Detective Actuators: Transistor PCB	Detective details: Error information received from Transistor PCB.
---	--

Forecast of Cause:

1. External cause. 2. Power supply to Filter PCB to Inverter PCB wiring disconnection, open 3. Filter PCB failure
4. Transistor PCB failure

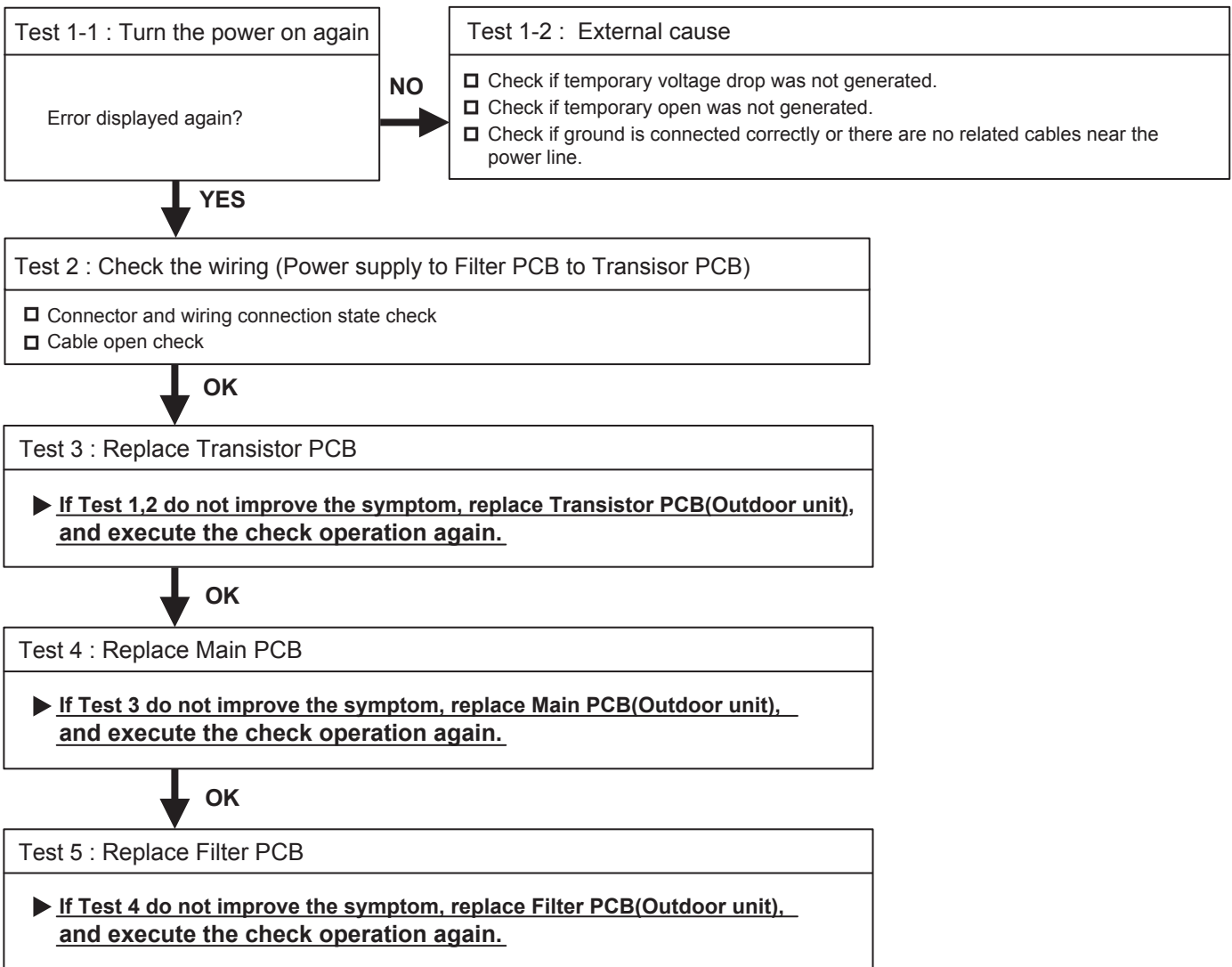

<p>Trouble shooting 16 <u>OUTDOOR UNIT Error Method:</u> Active Filter Error</p>	<p><u>Indicate of Display:</u> Indoor Unit : Operation lamp: 6 times Flash, Timer lamp : 4 times Flash ERROR CODE : [E : 64]</p>	<p>Outdoor unit : No indication</p>
---	---	--

<p><u>Detective Actuators:</u> Outdoor unit main PCB Active filter module Transistor PCB</p>	<p><u>Detective details:</u> ① When inverter input DC voltage is higher than 430V or lower than 110V. ② When a momentary power cut off occurred on low voltage.</p>
--	--

<p><u>Forecast of Cause:</u> 1. External cause 2. Connector connection failure 3. Main PCB failure 4. Active filter module failure 5. Transistor PCB failure</p>

<p>Test 1 : Check external cause at Indoor and Outdoor (Voltage drop or Noise)</p> <ul style="list-style-type: none"> • Instant drop : Check if there is a large load electric apparatus in the same circuit. • Momentary power failure : Check if there is a defective contact or leak current in the power supply circuit. • Noise : Check if there is any equipment causing harmonic wave near electric line. (Neon bulb or electric equipment that may cause harmonic wave) Check the complete insulation of grounding.

↓
OK

<p>Test 2 : Check connection of Connector</p> <ul style="list-style-type: none"> • Check if connector is removed. • Check erroneous connection. • Check if cable is open. <p>>><u>Upon correcting the removed connector or miss-wiring, reset the power.</u></p>

↓
OK

<p>Test 3 : Check Active filter module</p> <ul style="list-style-type: none"> • Check Active filter module. <p>>><u>If Active filter module is abnormal, replace it.</u></p>

↓
OK

<p>Test 4 : Check Transistor PCB</p> <ul style="list-style-type: none"> • Check Transistor PCB <p>>><u>If Transistor PCB is abnormal, replace it.</u></p>
--

↓
OK

<p>Test 5 : Replace Main PCB</p> <p>▶ <u>If Test 1 - 4 do not improve the symptom, change Main PCB.</u></p>

Trouble shooting 17 <u>OUTDOOR UNIT Error Method:</u> IPM Error	<u>Indicate of Display:</u> Indoor Unit : Operation lamp : 6 times Flash, Timer lamp : 5 times Flash ERROR CODE : [E : 65]	Outdoor unit : <table border="1" style="width: 100%; border-collapse: collapse; text-align: center;"> <tr> <td>POWER</td> <td>ERROR</td> <td>PUMP DOWN</td> <td colspan="3">LOW NOISE</td> <td colspan="3">PEAK CUT</td> </tr> <tr> <td>MODE</td> <td></td> <td>(L1)</td> <td>(L2)</td> <td>(L3)</td> <td>(L4)</td> <td>(L5)</td> <td>(L6)</td> </tr> <tr> <td>◆2</td> <td>●</td> <td>◆6</td> <td>◆5</td> <td>○</td> <td>○</td> <td>●</td> <td>●</td> </tr> </table> <p style="font-size: small;">○ : Light OFF ● : Light ON ◆n : n times blinking</p>	POWER	ERROR	PUMP DOWN	LOW NOISE			PEAK CUT			MODE		(L1)	(L2)	(L3)	(L4)	(L5)	(L6)	◆2	●	◆6	◆5	○	○	●	●
POWER	ERROR	PUMP DOWN	LOW NOISE			PEAK CUT																					
MODE		(L1)	(L2)	(L3)	(L4)	(L5)	(L6)																				
◆2	●	◆6	◆5	○	○	●	●																				

<u>Detective Actuators:</u> Outdoor unit main PCB Compressor Transistor PCB	<u>Detective details:</u> ① When more than normal operating current to IPM in Main PCB flows, the compressor stops. ② After the compressor restarts. If the same operation is repeated within 40sec, the compressor stops. ③ If ① and ② repeats 5 times, the compressor stops permanently.
---	--

Forecast of Cause:

1. Defective connection of electric components 2. Outdoor Fan Operation failure
 3. Outdoor Heat Exchanger clogged 4. Compressor failure 5. Main PCB failure 6. Transistor PCB failure

Test 1 : Check connections of Outdoor Unit Electrical Components

- Check if the terminal connection is loose.
- Check if connector is removed.
- Check erroneous connection.
- Check if cable is open.

>> Upon correcting the removed connector or miss-wiring, reset the power.



Test 2 : Check Outdoor Fan, Heat Exchanger

- Is there anything obstructing the air distribution circuit?
- Is there any clogging of Outdoor Heat Exchanger?
- Is the Fan rotating by hand when operation is off ?

>> If the Fan Motor is locked, replace it.



Test 3 : Check Outdoor Fan

- Check Outdoor Fan Motor. (Refer to Trouble shooting 28,29)

>> If the Fan Motor is failure, replace it.



Test 4 : Check Compressor

- Check Compressor. (**SERVICE PARTS INFORMATION 2**)



Test 5 : Check Transistor PCB

- Check Transistor PCB

>> If Transistor PCB is abnormal, replace it.



Test 6 : Replace Main PCB

▶ If Test 1 - 5 do not improve the symptom, change Main PCB.

Trouble shooting 18 OUTDOOR UNIT Error Method: Discharge Thermistor Error	Indicate of Display: Indoor Unit : Operation lamp: 7 times Flash, Timer lamp : 1 times Flash ERROR CODE : [E : 71]	Outdoor unit : <table border="1" style="width: 100%; border-collapse: collapse; text-align: center;"> <tr> <td>POWER</td> <td>ERROR</td> <td>PUMP DOWN</td> <td colspan="2">LOW NOISE</td> <td colspan="2">PEAK CUT</td> </tr> <tr> <td>MODE</td> <td></td> <td>(L1)</td> <td>(L2)</td> <td>(L3)</td> <td>(L4)</td> <td>(L5) (L6)</td> </tr> <tr> <td>◆2</td> <td>●</td> <td>◆7</td> <td>◆1</td> <td>○</td> <td>○</td> <td>○ ●</td> </tr> </table> <p>○: Light OFF ●: Light ON ◆n: n times blinking</p>	POWER	ERROR	PUMP DOWN	LOW NOISE		PEAK CUT		MODE		(L1)	(L2)	(L3)	(L4)	(L5) (L6)	◆2	●	◆7	◆1	○	○	○ ●
POWER	ERROR	PUMP DOWN	LOW NOISE		PEAK CUT																		
MODE		(L1)	(L2)	(L3)	(L4)	(L5) (L6)																	
◆2	●	◆7	◆1	○	○	○ ●																	

Detective Actuators: Discharge temperature thermistor	Detective details: When Discharge temperature thermistor open or short-circuit is detected at power ON or while running compressor.
---	---

Forecast of Cause:

1. Connector connection failure, open 2. Thermistor failure 3. Main PCB failure

Test 1 : Check connection of Connector

- Check if connector is loose or removed
- Check erroneous connection
- Check if thermistor cable is open

>>Reset Power when reinstalling due to removed connector or incorrect wiring.



Test 2 : Remove connector and check Thermistor resistance value									
Thermistor Characteristics(Rough value)									
Temperature (°C)	-20	-10	0	10	20	30	40	50	60
Temperature (°F)	-4	14	32	50	68	86	104	122	140
Resistance value (kΩ)	531.56	292.91	168.60	100.91	62.55	40.01	26.34	17.79	12.30

Temperature (°C)	70	80	90	100	110	120
Temperature (°F)	158	176	194	212	230	248
Resistance value (kΩ)	8.70	6.27	4.60	3.43	2.60	2.00

► If Thermistor is either open or shorted, replace it and reset the power.



Test 3 : Check Voltage of Controller PCB (DC 5.0V)	
Make sure circuit diagram of each indoor unit and check terminal voltage at Thermistor (DC5.0V)	
► If the voltage does not appear, replace Controller PCB and execute the check operation again.	

Trouble shooting 19 OUTDOOR UNIT Error Method: Compressor Thermistor Error	Indicate of Display: Indoor Unit : Operation lamp: 7 times Flash, Timer lamp : 2 times Flash ERROR CODE : [E : 72]	Outdoor unit : <table border="1" style="width: 100%; border-collapse: collapse; text-align: center;"> <tr> <td>POWER</td> <td>ERROR</td> <td>PUMP DOWN</td> <td colspan="3">LOW NOISE</td> <td colspan="3">PEAK CUT</td> </tr> <tr> <td>MODE</td> <td></td> <td>(L1)</td> <td>(L2)</td> <td>(L3)</td> <td>(L4)</td> <td>(L5)</td> <td>(L6)</td> <td></td> </tr> <tr> <td>◆2</td> <td>●</td> <td>◆7</td> <td>◆2</td> <td>○</td> <td>○</td> <td>○</td> <td>○</td> <td>●</td> </tr> </table> <p>○: Light OFF ●: Light ON ◆n: n times blinking</p>	POWER	ERROR	PUMP DOWN	LOW NOISE			PEAK CUT			MODE		(L1)	(L2)	(L3)	(L4)	(L5)	(L6)		◆2	●	◆7	◆2	○	○	○	○	●
POWER	ERROR	PUMP DOWN	LOW NOISE			PEAK CUT																							
MODE		(L1)	(L2)	(L3)	(L4)	(L5)	(L6)																						
◆2	●	◆7	◆2	○	○	○	○	●																					

Detective Actuators: Compressor temperature thermistor	Detective details: When Compressor temperature thermistor open or short-circuit is detected at power ON or while running compressor.
--	--

Forecast of Cause:

1. Connector connection failure, open 2. Thermistor failure 3. Main PCB failure

Test 1 : Check connection of Connector

- Check if connector is loose or removed
- Check erroneous connection
- Check if thermistor cable is open

>>Reset Power when reinstalling due to removed connector or incorrect wiring.



Test 2 : Remove connector and check Thermistor resistance value									
Thermistor Characteristics(Rough value)									
Temperature (°C)	-20	-10	0	10	20	30	40	50	60
Temperature (°F)	-4	14	32	50	68	86	104	122	140
Resistance value (kΩ)	531.56	292.91	168.60	100.91	62.55	40.01	26.34	17.79	12.30

Temperature (°C)	70	80	90	100	110	120
Temperature (°F)	158	176	194	212	230	248
Resistance value (kΩ)	8.70	6.27	4.60	3.43	2.60	2.00

► If Thermistor is either open or shorted, replace it and reset the power.



Test 3 : Check Voltage of Controller PCB (DC 5.0V)	
Make sure circuit diagram of each indoor unit and check terminal voltage at Thermistor (DC5.0V)	
► If the voltage does not appear, replace Controller PCB and execute the check operation again.	

Trouble shooting 20 OUTDOOR UNIT Error Method: Heat Ex. Middle Temp. Thermistor Error	Indicate of Display: Indoor Unit : Operation lamp : 7 times Flash, Timer lamp : 3 times Flash ERROR CODE : [E : 73]	Outdoor unit : <table border="1" style="width: 100%; border-collapse: collapse; text-align: center;"> <tr> <td>POWER</td> <td>ERROR</td> <td>PUMP DOWN</td> <td colspan="3">LOW NOISE</td> <td colspan="3">PEAK CUT</td> </tr> <tr> <td>MODE</td> <td></td> <td>(L1)</td> <td>(L2)</td> <td>(L3)</td> <td>(L4)</td> <td>(L5)</td> <td>(L6)</td> <td></td> </tr> <tr> <td>◆2</td> <td>●</td> <td>◆7</td> <td>◆13</td> <td>○</td> <td>○</td> <td>●</td> <td>○</td> <td></td> </tr> </table> <p>○ : Light OFF ● : Light ON ◆n : n times blinking</p>	POWER	ERROR	PUMP DOWN	LOW NOISE			PEAK CUT			MODE		(L1)	(L2)	(L3)	(L4)	(L5)	(L6)		◆2	●	◆7	◆13	○	○	●	○	
POWER	ERROR	PUMP DOWN	LOW NOISE			PEAK CUT																							
MODE		(L1)	(L2)	(L3)	(L4)	(L5)	(L6)																						
◆2	●	◆7	◆13	○	○	●	○																						

Detective Actuators: Heat ex. middle temp. thermistor	Detective details: When Heat exchanger middle temperature thermistor open or short-circuit is detected at power ON or while running compressor.
---	---

Forecast of Cause:

1. Connector connection failure, open 2. Thermistor failure 3. Main PCB failure

Test 1 : Check connection of Connector

- Check if connector is loose or removed
- Check erroneous connection
- Check if thermistor cable is open

>>Reset Power when reinstalling due to removed connector or incorrect wiring.



Test 2 : Remove connector and check Thermistor resistance value									
Thermistor Characteristics(Rough value)									
Temperature (°C)	-30	-20	-10	0	10	20	30	40	50
Temperature (°F)	-22	-4	14	32	50	68	86	104	122
Resistance value (kΩ)	95.58	50.31	27.81	16.05	103.34	9.63	3.84	2.53	1.71

Temperature (°C)	60	70	80	90
Temperature (°F)	140	158	176	194
Resistance value (kΩ)	1.19	0.84	0.61	0.45

► If Thermistor is either open or shorted, replace it and reset the power.



Test 3 : Check Voltage of Controller PCB (DC 5.0V)	DC
Make sure circuit diagram of each indoor unit and check terminal voltage at Thermistor (DC5.0V)	
► If the voltage does not appear, replace Controller PCB and execute the check operation again.	

Trouble shooting 21 OUTDOOR UNIT Error Method: Heat Ex. Liquid Temp. Thermistor Error	Indicate of Display: Indoor Unit : Operation lamp : 7 times Flash, Timer lamp : 3 times Flash ERROR CODE : [E : 73]	Outdoor unit : <table border="1" style="width: 100%; border-collapse: collapse; text-align: center;"> <tr> <td>POWER</td> <td>ERROR</td> <td>PUMP DOWN</td> <td colspan="3">LOW NOISE</td> <td colspan="2">PEAK CUT</td> </tr> <tr> <td>MODE</td> <td></td> <td>(L1)</td> <td>(L2)</td> <td>(L3)</td> <td>(L4)</td> <td>(L5)</td> <td>(L6)</td> </tr> <tr> <td>◆2</td> <td>●</td> <td>◆7</td> <td>◆13</td> <td>○</td> <td>○</td> <td>●</td> <td>●</td> </tr> </table> <p>○ : Light OFF ● : Light ON ◆n : n times blinking</p>	POWER	ERROR	PUMP DOWN	LOW NOISE			PEAK CUT		MODE		(L1)	(L2)	(L3)	(L4)	(L5)	(L6)	◆2	●	◆7	◆13	○	○	●	●
POWER	ERROR	PUMP DOWN	LOW NOISE			PEAK CUT																				
MODE		(L1)	(L2)	(L3)	(L4)	(L5)	(L6)																			
◆2	●	◆7	◆13	○	○	●	●																			

Detective Actuators: Heat ex. liquid temp. thermistor	Detective details: When Heat exchanger liquid temperature thermistor open or short-circuit is detected at power ON or while running compressor.
---	---

Forecast of Cause:

1. Connector connection failure, open 2. Thermistor failure 3. Main PCB failure

Test 1 : Check connection of Connector

- Check if connector is loose or removed
- Check erroneous connection
- Check if thermistor cable is open

>>Reset Power when reinstalling due to removed connector or incorrect wiring.



Test 2 : Remove connector and check Thermistor resistance value									
Thermistor Characteristics(Rough value)									
Temperature (°C)	-30	-20	-10	0	10	20	30	40	50
Temperature (°F)	-22	-4	14	32	50	68	86	104	122
Resistance value (kΩ)	95.58	50.31	27.81	16.05	103.34	9.63	3.84	2.53	1.71

Temperature (°C)	60	70	80	90
Temperature (°F)	140	158	176	194
Resistance value (kΩ)	1.19	0.84	0.61	0.45

► If Thermistor is either open or shorted, replace it and reset the power.



Test 3 : Check Voltage of Controller PCB (DC 5.0V)	
Make sure circuit diagram of each indoor unit and check terminal voltage at Thermistor (DC5.0V)	
► If the voltage does not appear, replace Controller PCB and execute the check operation again.	

Trouble shooting 22 OUTDOOR UNIT Error Method: Outdoor Thermistor Error	Indicate of Display: Indoor Unit : Operation lamp : 7 times Flash, Timer lamp : 4 times Flash ERROR CODE : [E : 74]	Outdoor unit : <table border="1" style="width: 100%; border-collapse: collapse; text-align: center;"> <tr> <td>POWER MODE</td> <td>ERROR</td> <td>PUMP DOWN (L1)</td> <td>LOW NOISE (L2)</td> <td>(L3)</td> <td colspan="3">PEAK CUT (L4) (L5) (L6)</td> </tr> <tr> <td>◆2</td> <td>●</td> <td>◆7</td> <td>◆4</td> <td>○</td> <td>○</td> <td>○</td> <td>●</td> </tr> </table> <p>○ : Light OFF ● : Light ON ◆n : n times blinking</p>	POWER MODE	ERROR	PUMP DOWN (L1)	LOW NOISE (L2)	(L3)	PEAK CUT (L4) (L5) (L6)			◆2	●	◆7	◆4	○	○	○	●
POWER MODE	ERROR	PUMP DOWN (L1)	LOW NOISE (L2)	(L3)	PEAK CUT (L4) (L5) (L6)													
◆2	●	◆7	◆4	○	○	○	●											

Detective Actuators: Outdoor temperature thermistor	Detective details: When Outdoor temperature thermistor open or short-circuit is detected at power ON or while running compressor.
---	---

Forecast of Cause:

1. Connector connection failure, open 2. Thermistor failure 3. Main PCB failure

Test 1 : Check connection of Connector

- Check if connector is loose or removed
- Check erroneous connection
- Check if thermistor cable is open

>>Reset Power when reinstalling due to removed connector or incorrect wiring.



Test 2 : Remove connector and check Thermistor resistance value										
Thermistor Characteristics(Rough value)										
Temperature (°C)	-30	-20	-10	0	10	20	30	40	50	
Temperature (°F)	-22	-4	14	32	50	68	86	104	122	
Resistance value (kΩ)	224.33	115.24	62.28	35.21	20.72	12.64	7.97	5.18	3.45	
Temperature (°C)	60	70	80							
Temperature (°F)	140	158	176							
Resistance value (kΩ)	2.36	1.65	1.65							
<p>▶ If Thermistor is either open or shorted, replace it and reset the power.</p>										



Test 3 : Check Voltage of Controller PCB (DC 5.0V)								
Make sure circuit diagram of each indoor unit and check terminal voltage at Thermistor (DC5.0V)								
CN61	<table border="1" style="border-collapse: collapse;"> <tr><td>1</td><td>1</td></tr> <tr><td>2</td><td>2</td></tr> <tr><td>3</td><td>3</td></tr> </table>	1	1	2	2	3	3	<p>Outdoor Temp. Thermistor</p>
1	1							
2	2							
3	3							
<p>▶ If the voltage does not appear, replace Controller PCB and execute the check operation again.</p>								

<p>Trouble shooting 23 OUTDOOR UNIT Error Method: Heat Sink Thermistor Error</p>	<p>Indicate or Display: Indoor Unit : Operation lamp: 7 times Flash, Timer lamp : 7 times Flash ERROR CODE : [E : 77]</p>	<p>Outdoor unit :</p> <table border="1" data-bbox="1071 252 1477 321"> <tr> <th>Mode</th> <th>Error</th> <th>L1</th> <th>L2</th> <th>L3</th> <th>L4</th> <th>L5</th> <th>L6</th> </tr> <tr> <td>◆2</td> <td>●</td> <td>◆7</td> <td>◆7</td> <td>○</td> <td>○</td> <td>○</td> <td>●</td> </tr> </table> <p>○ : Light OFF ● : Light ON ◆n : n times blinking</p>	Mode	Error	L1	L2	L3	L4	L5	L6	◆2	●	◆7	◆7	○	○	○	●
Mode	Error	L1	L2	L3	L4	L5	L6											
◆2	●	◆7	◆7	○	○	○	●											

<p>Detective Actuators: Inverter PCB</p>	<p>Detective details: • Heat sink temperature thermistor (Built-in IPM) open/short detected</p>
---	--

<p>Forecast of Cause : 1. Inverter PCB failure ▶ <u>If this error is displayed, replace Inverter PCB</u></p>

Trouble shooting 24 OUTDOOR UNIT Error Method: Current Sensor Error	Indicate of Display: Indoor Unit : Operation lamp : 8 times Flash, Timer lamp : 4 times Flash ERROR CODE : [E : 84]	Outdoor unit : <table border="1" style="width: 100%; border-collapse: collapse; text-align: center;"> <tr> <td style="font-size: 8px;">POWER</td> <td style="font-size: 8px;">ERROR</td> <td style="font-size: 8px;">PUMP DOWN</td> <td colspan="3" style="font-size: 8px;">LOW NOISE</td> <td colspan="3" style="font-size: 8px;">PEAK CUT</td> </tr> <tr> <td style="font-size: 8px;">MODE</td> <td></td> <td style="font-size: 8px;">(L1)</td> <td style="font-size: 8px;">(L2)</td> <td style="font-size: 8px;">(L3)</td> <td style="font-size: 8px;">(L4)</td> <td style="font-size: 8px;">(L5)</td> <td style="font-size: 8px;">(L6)</td> <td></td> </tr> <tr> <td style="font-size: 8px;">◆2</td> <td style="font-size: 8px;">●</td> <td style="font-size: 8px;">◆8</td> <td style="font-size: 8px;">◆4</td> <td style="font-size: 8px;">○</td> <td style="font-size: 8px;">○</td> <td style="font-size: 8px;">○</td> <td style="font-size: 8px;">○</td> <td style="font-size: 8px;">●</td> </tr> </table> <p style="font-size: 8px;">○: Light OFF ●: Light ON ◆n: n times blinking</p>	POWER	ERROR	PUMP DOWN	LOW NOISE			PEAK CUT			MODE		(L1)	(L2)	(L3)	(L4)	(L5)	(L6)		◆2	●	◆8	◆4	○	○	○	○	●
POWER	ERROR	PUMP DOWN	LOW NOISE			PEAK CUT																							
MODE		(L1)	(L2)	(L3)	(L4)	(L5)	(L6)																						
◆2	●	◆8	◆4	○	○	○	○	●																					

Detective Actuators: Outdoor unit main PCB	Detective details: When input Current Sensor has detected 0A, while inverter compressor is operating at higher than 50Hz. after 1 minute upon starting the compressor (Except during the defrost operation)
--	---

Forecast of Cause:

1. Defective connection of electric components 2. External cause 3. Filter PCB failure 4. Main PCB failure

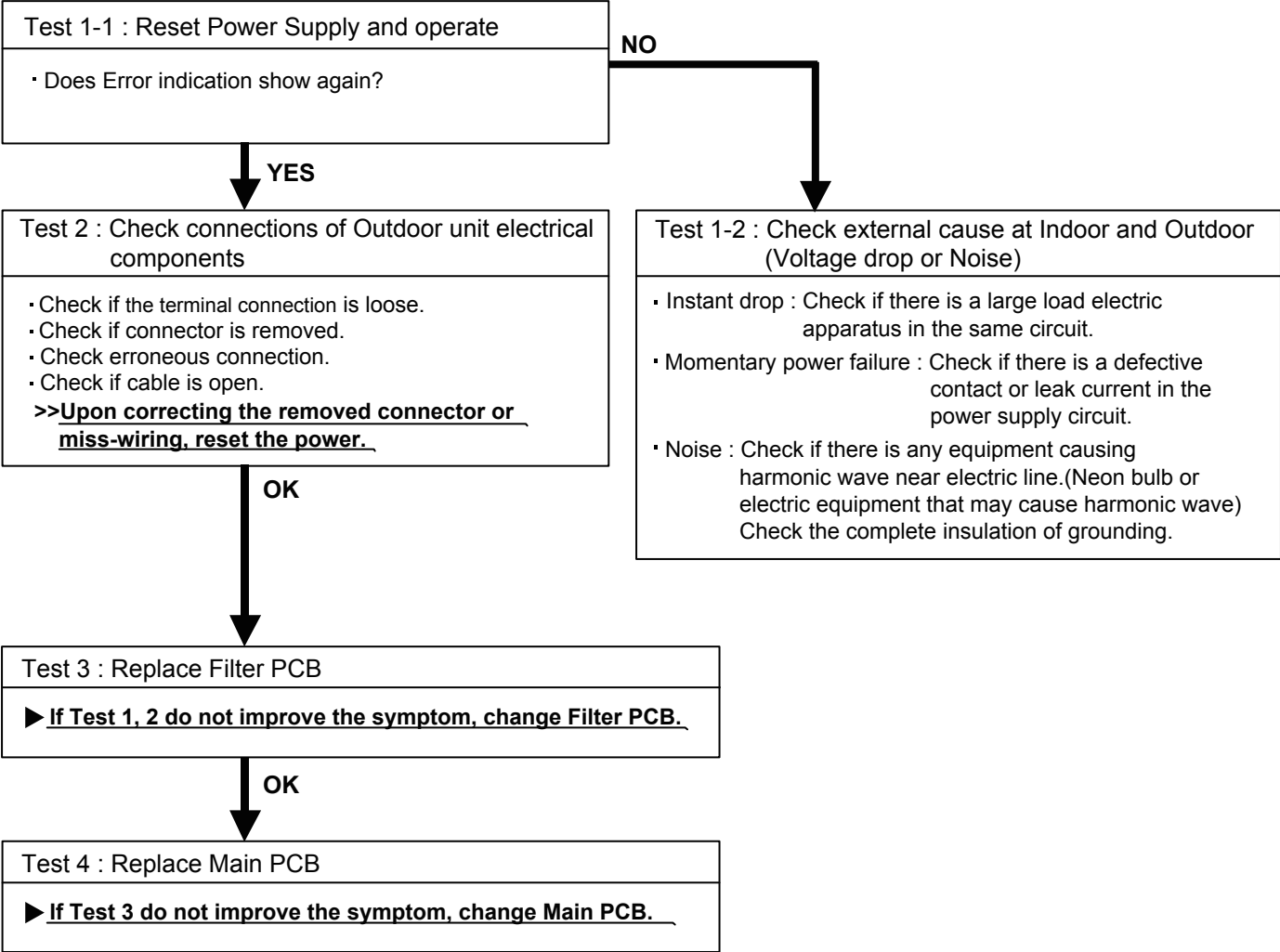

<p>Trouble shooting 25 OUTDOOR UNIT Error Method: Pressure Sensor Error</p>	<p>Indicate of Display: Indoor Unit : Operation lamp: 8 times Flash, Timer lamp : 6 times Flash ERROR CODE : [E : 86]</p>	<p>Outdoor unit :</p> <table border="1" style="width: 100%; border-collapse: collapse; text-align: center;"> <thead> <tr> <th>POWER</th> <th>ERROR</th> <th colspan="3">PUMP DOWN</th> <th colspan="3">LOW NOISE</th> <th colspan="3">PEAK CUT</th> </tr> <tr> <th>MODE</th> <th></th> <th>(L1)</th> <th>(L2)</th> <th>(L3)</th> <th>(L4)</th> <th>(L5)</th> <th>(L6)</th> <th></th> <th></th> <th></th> </tr> </thead> <tbody> <tr> <td>◆2</td> <td>●</td> <td>◆8</td> <td>◆6</td> <td>○</td> <td>●</td> <td>○</td> <td>○</td> <td></td> <td></td> <td></td> </tr> </tbody> </table> <p>○: Light OFF ●: Light ON ◆n: n times blinking</p>	POWER	ERROR	PUMP DOWN			LOW NOISE			PEAK CUT			MODE		(L1)	(L2)	(L3)	(L4)	(L5)	(L6)				◆2	●	◆8	◆6	○	●	○	○			
POWER	ERROR	PUMP DOWN			LOW NOISE			PEAK CUT																											
MODE		(L1)	(L2)	(L3)	(L4)	(L5)	(L6)																												
◆2	●	◆8	◆6	○	●	○	○																												

<p>Detective Actuators: Outdoor unit main PCB</p>	<p>Detective details: 30 seconds or more after power-on, when pressure sensor detection value detects the condition below continuously for 30 seconds or more. $P_s \leq 37.71 \text{ psi } (-0.26 \text{ Mpa})$ or $P_s \geq 816.56 \text{ psi } (5.63 \text{ Mpa})$</p>
---	--

Forecast of Cause:

1. Connector connection failure 2. Pressure sensor failure 3. Main PCB failure

Test 1 : Check the connection of the pressure sensor

- Check if the terminal connection is loose.
- Check if connector is removed.
- Check if connector is erroneous connection.
- Check if cable is open.

>>Upon correcting the removed connector or miss-wiring, reset the power.



<p>Test 2 : Check Voltage from Main PCB</p> <p>□ With the connector connected to the PCB, measure the voltage between CN91:3-4 of the Main PCB.</p>	<div style="border: 1px solid black; padding: 5px; width: fit-content; margin: 0 auto;"> <p>DC</p> </div>
	<p>▪ Characteristics of pressure sensor</p>
<p>▶ If the voltage is not on the connector, replace Main PCB.</p> <p>▶ If the voltage is incorrect value, replace the Pressure sensor.</p>	

Trouble shooting 26 OUTDOOR UNIT Error Method: Over Current Error	Indicate of Display: Indoor Unit : Operation lamp: 9 times Flash, Timer lamp : 4 times Flash ERROR CODE : [E : 94]	Outdoor unit : <table border="1" style="width: 100%; border-collapse: collapse; text-align: center;"> <thead> <tr> <th>POWER</th> <th>ERROR</th> <th>PUMP DOWN</th> <th colspan="3">LOW NOISE</th> <th colspan="2">PEAK CUT</th> </tr> <tr> <th>MODE</th> <th></th> <th>(L1)</th> <th>(L2)</th> <th>(L3)</th> <th>(L4)</th> <th>(L5)</th> <th>(L6)</th> </tr> </thead> <tbody> <tr> <td>◆2</td> <td>●</td> <td>◆9</td> <td>◆4</td> <td>○</td> <td>○</td> <td>○</td> <td>●</td> </tr> </tbody> </table> <p>○ : Light OFF ● : Light ON ◆n : n times blinking</p>	POWER	ERROR	PUMP DOWN	LOW NOISE			PEAK CUT		MODE		(L1)	(L2)	(L3)	(L4)	(L5)	(L6)	◆2	●	◆9	◆4	○	○	○	●
POWER	ERROR	PUMP DOWN	LOW NOISE			PEAK CUT																				
MODE		(L1)	(L2)	(L3)	(L4)	(L5)	(L6)																			
◆2	●	◆9	◆4	○	○	○	●																			

Detective Actuators: Outdoor unit main PCB Compressor Transistor PCB	Detective details: “Protection stop by overcurrent generation after inverter compressor start processing completed” generated consecutively 10 times. *The number of generations is reset if the start-up of the compressor succeeds.
--	--

Forecast of Cause:

1. Outdoor unit fan operation defective, foreign matter on heat exchanger, excessive rise of ambient temperature
2. Main PCB 3. Inverter compressor failure (lock, winding short) 4. Transistor PCB (IPM) failure

Test 1 : Check the outdoor unit fan operation, heat exchanger, ambient temperature

- No obstructions in air passages?
- Heat exchange fins clogged
- Outdoor unit fan motor check
- Ambient temperature not raised by the effect of other heat sources?
- Discharged air not sucked in?

↓
OK

Test 2 : Check Transistor PCB (IPM)

- Check IPM. (**SERVICE PARTS INFORMATION 8**)
 >> **If IPM is abnormal, replace Transistor PCB.**

↓
OK

Test 3 : Replace Main PCB

▶ **If Test 1 or 1, 2 do not improve the symptom, change Main PCB.**

↓
OK

Test 4 : Replace Compressor

▶ **If Test 3 do not improve the symptom, change Compressor.**

Trouble shooting 27 OUTDOOR UNIT Error Method: Compressor Control Error	Indicate of Display: Indoor Unit : Operation lamp: 9 times Flash, Timer lamp : 5 times Flash ERROR CODE : [E : 95]		Outdoor unit : <table border="1"> <thead> <tr> <th>POWER</th> <th>ERROR</th> <th colspan="2">PUMP DOWN</th> <th colspan="2">LOW NOISE</th> <th colspan="2">PEAK CUT</th> </tr> <tr> <th>MODE</th> <th></th> <th>(L1)</th> <th>(L2)</th> <th>(L3)</th> <th>(L4)</th> <th>(L5)</th> <th>(L6)</th> </tr> </thead> <tbody> <tr> <td>◆2</td> <td>●</td> <td>◆9</td> <td>◆5</td> <td>○</td> <td>○</td> <td>○</td> <td>●</td> </tr> </tbody> </table>						POWER	ERROR	PUMP DOWN		LOW NOISE		PEAK CUT		MODE		(L1)	(L2)	(L3)	(L4)	(L5)	(L6)	◆2	●	◆9	◆5	○	○	○	●
	POWER	ERROR	PUMP DOWN		LOW NOISE		PEAK CUT																									
MODE		(L1)	(L2)	(L3)	(L4)	(L5)	(L6)																									
◆2	●	◆9	◆5	○	○	○	●																									
○: Light OFF ●: Light ON ◆n: n times blinking																																

Detective Actuators: Outdoor unit main PCB Compressor Transistor PCB	Detective details: While running the compressor, if the detected rotor location is out of phase with actual rotor location more than 90°, the compressor stops. After the compressor restarts, if the same operation is repeated within 40sec, the compressor stops again. If and repeats 5 times, the compressor stops permanently.
--	--

Forecast of Cause: 1. Defective connection of electric components 2. Main PCB failure 3. Compressor failure 4. Transistor PCB (IPM) failure
--

Test 1 : Check Noise from Compressor

- Turn on Power and check operation noise.

▶ **If an abnormal noise show, replace Compressor.**



Test 2 : Check connection of around the Compressor components

For Compressor Terminal, Main PCB

- Check if connector is removed.
- Check erroneous connection.
- Check if cable is open.

(SERVICE PARTS INFORMATION 2)

>> **Upon correcting the removed connector or miss-wiring, reset the power.**



Test 3 : Check Transistor PCB (IPM)

- Check IPM. **(SERVICE PARTS INFORMATION 8)**

>> **If IPM is abnormal, replace Transistor PCB.**



Test 4 : Replace Main PCB

▶ **If Test 1,2 or 1 - 3 do not improve the symptom, change Main PCB.**



Test 5 : Replace Compressor

▶ **If Test 4 do not improve the symptom, change Compressor.**

Trouble shooting 28 OUTDOOR UNIT Error Method: Outdoor Unit Fan Motor 1 Error	Indicate of Display: Indoor Unit : Operation lamp: 9 times Flash, Timer lamp : 7 times Flash ERROR CODE : [E : 97]	Outdoor unit : <table border="1" style="width: 100%; border-collapse: collapse; text-align: center;"> <tr> <td>POWER</td> <td>ERROR</td> <td>PUMP DOWN</td> <td colspan="3">LOW NOISE</td> <td colspan="2">PEAK CUT</td> </tr> <tr> <td>MODE</td> <td></td> <td>(L1)</td> <td>(L2)</td> <td>(L3)</td> <td>(L4)</td> <td>(L5)</td> <td>(L6)</td> </tr> <tr> <td>◆2</td> <td>●</td> <td>◆9</td> <td>◆7</td> <td>○</td> <td>○</td> <td>●</td> <td>●</td> </tr> </table> <p>○ : Light OFF ● : Light ON ◆n : n times blinking</p>	POWER	ERROR	PUMP DOWN	LOW NOISE			PEAK CUT		MODE		(L1)	(L2)	(L3)	(L4)	(L5)	(L6)	◆2	●	◆9	◆7	○	○	●	●
POWER	ERROR	PUMP DOWN	LOW NOISE			PEAK CUT																				
MODE		(L1)	(L2)	(L3)	(L4)	(L5)	(L6)																			
◆2	●	◆9	◆7	○	○	●	●																			

Detective Actuators: Outdoor unit main PCB Outdoor unit fan motor	Detective details: ① When outdoor fan rotation speed is less than 100rpm in 20 seconds after fan motor starts, fan motor stops. ② After fan motor restarts, if the same operation within 60sec is repeated 3 times in a row, compressor and fan motor stops. ③ If ① and ② repeats 5 times in a row, compressor and fan motor stops permanently.
--	---

Forecast of Cause:

1. Fan rotation failure 2. Motor protection by surrounding temperature rise 3. Main PCB failure
 4. Outdoor unit fan motor failure

Test 1 : Check rotation of Fan

• Rotate the fan by hand when operation is off.
 (Check if fan is caught, dropped off or locked motor)
>>If Fan or Bearing is abnormal, replace it.



Test 2 : Check ambient temp. around motor

• Check excessively high temperature around the motor.
 (If there is any surrounding equipment that causes heat)
>>Upon the temperature coming down, restart operation.



Test 3 : Check Outdoor unit fan motor

• Check Outdoor unit fan motor. **(SERVICE PARTS INFORMATION 5)**
>>If Outdoor Fan Motor is abnormal, replace Outdoor fan motor and Main PCB.



Test 4 : Check Output Voltage of Main PCB

• Check outdoor unit circuit diagram and the voltage. (Measure at Main PCB side connector)

Read wire	DC voltage
Red - Black	260 - 400V
White - Black	15 ± 1.5V

► If the voltage is not correct, replace Main PCB.

<p>Trouble shooting 29 OUTDOOR UNIT Error Method: Outdoor Unit Fan Motor 2 Error</p>	<p>Indicate of Display: Indoor Unit : Operation lamp : 9 times Flash, Timer lamp : 8 times Flash ERROR CODE : [E : 98]</p>	<p>Outdoor unit :</p> <table border="1" style="width: 100%; border-collapse: collapse; text-align: center;"> <tr> <td>POWER</td> <td>ERROR</td> <td>PUMP DOWN</td> <td colspan="3">LOW NOISE</td> <td colspan="2">PEAK CUT</td> </tr> <tr> <td>MODE</td> <td></td> <td>(L1)</td> <td>(L2)</td> <td>(L3)</td> <td>(L4)</td> <td>(L5)</td> <td>(L6)</td> </tr> <tr> <td>◆2</td> <td>●</td> <td>◆9</td> <td>◆8</td> <td>○</td> <td>○</td> <td>●</td> <td>●</td> </tr> </table> <p>○: Light OFF ●: Light ON ◆n: n times blinking</p>	POWER	ERROR	PUMP DOWN	LOW NOISE			PEAK CUT		MODE		(L1)	(L2)	(L3)	(L4)	(L5)	(L6)	◆2	●	◆9	◆8	○	○	●	●
POWER	ERROR	PUMP DOWN	LOW NOISE			PEAK CUT																				
MODE		(L1)	(L2)	(L3)	(L4)	(L5)	(L6)																			
◆2	●	◆9	◆8	○	○	●	●																			

<p>Detective Actuators:</p> <p>Outdoor unit main PCB Outdoor unit fan motor</p>	<p>Detective details:</p> <p>① When outdoor fan rotation speed is less than 100rpm in 20 seconds after fan motor starts, fan motor stops. ② After fan motor restarts, if the same operation within 60sec is repeated 3 times in a row, compressor and fan motor stops. ③ If ① and ② repeats 5 times in a row, compressor and fan motor stops permanently.</p>
---	--

Forecast of Cause:

1. Fan rotation failure 2. Motor protection by surrounding temperature rise 3. Main PCB failure
 4. Outdoor unit fan motor failure

Test 1 : Check rotation of Fan

- Rotate the fan by hand when operation is off.
 (Check if fan is caught, dropped off or locked motor)

>>If Fan or Bearing is abnormal, replace it.



Test 2 : Check ambient temp. around motor

- Check excessively high temperature around the motor.
 (If there is any surrounding equipment that causes heat)

>>Upon the temperature coming down, restart operation.



Test 3 : Check Outdoor unit fan motor

- Check Outdoor unit fan motor. **(SERVICE PARTS INFORMATION 5)**

>>If Outdoor Fan Motor is abnormal, replace Outdoor fan motor and Main PCB.



Test 4 : Check Output Voltage of Main PCB

- Check outdoor unit circuit diagram and the voltage. (Measure at Main PCB side connector)

Read wire	DC voltage
Red - Black	260 - 400V
White - Black	15 ± 1.5V

▶ If the voltage is not correct, replace Main PCB.

Trouble shooting 30 <u>OUTDOOR UNIT Error Method:</u> 4-Way Valve Error	<u>Indicate of Display:</u> Indoor Unit : Operation lamp : 9 times Flash, Timer lamp : 9 times Flash ERROR CODE : [E : 99]	Outdoor unit : <table border="1" style="width: 100%; border-collapse: collapse; text-align: center;"> <thead> <tr> <th>POWER MODE</th> <th>ERROR</th> <th>PUMP DOWN (L1)</th> <th colspan="3">LOW NOISE (L2) (L3)</th> <th colspan="3">PEAK CUT (L4) (L5) (L6)</th> </tr> </thead> <tbody> <tr> <td>◆2</td> <td>●</td> <td>◆9</td> <td>◆9</td> <td>○</td> <td>○</td> <td>○</td> <td>○</td> <td>●</td> </tr> </tbody> </table> <p>○: Light OFF ●: Light ON ◆n: n times blinking</p>	POWER MODE	ERROR	PUMP DOWN (L1)	LOW NOISE (L2) (L3)			PEAK CUT (L4) (L5) (L6)			◆2	●	◆9	◆9	○	○	○	○	●
POWER MODE	ERROR	PUMP DOWN (L1)	LOW NOISE (L2) (L3)			PEAK CUT (L4) (L5) (L6)														
◆2	●	◆9	◆9	○	○	○	○	●												

<u>Detective Actuators:</u> Indoor unit controller PCB circuit Heat Ex. temperature thermistor Room temperature thermistor 4-way valve	<u>Detective details:</u> When the indoor heat exchanger temperature is compared with the room temperature, and either following condition is decided continuously two times, the compressor stops. Cooling or Dry operation. [Indoor heat exchanger temp.] - [Room temp.] > 50°F (10°C) Heating operation [Indoor heat exchanger temp.] - [Room temp.] < -50°F (-10°C) If the same operation is repeated 5 times, the compressor stops permanently.
---	---

Forecast of Cause:

1. Connector connection failure 2. Thermistor failure 3. Coil failure 4. 4-way valve failure
 5. Main PCB failure

Test 1 : Check connection of Connector

- Check if connector is removed.
- Check erroneous connection.
- Check if thermistor cable is open.

>> Upon correcting the removed connector or miss-wiring, reset the power.



Test 2 : Check thermistor of Indoor unit

- Isn't it fallen off the holder?
- Is there a cable pinched?

>> Check characteristics of thermistor, (Refer to Trouble shooting 11,12), If defective, replace the thermistor.



Test 3 : Check the solenoid coil and 4-way valve

[Solenoid coil]

- Remove CN6 from PCB and check the resistance value of coil.
Resistance value is about 1725 ± 172.5 Ω (68°F (20°C))

>> If it is Open or abnormal resistance value, replace Solenoid Coil.

[4-way valve]

- Check each piping temperature, and the location of the valve by the temperature difference.

>> If the value location is not proper, replace 4-way valve.



Test 4 : Replace Main PCB

▶ If Test 1- 3 do not improve the symptom, replace Main PCB.

Trouble shooting 31 OUTDOOR UNIT Error Method: Discharge Temp. Error	Indicate of Display: Indoor Unit : Operation lamp : 10 times Flash, Timer lamp : 1 times Flash ERROR CODE : [E : A1]	Outdoor unit : <table border="1"> <thead> <tr> <th>POWER</th> <th>ERROR</th> <th>PUMP DOWN</th> <th colspan="3">LOW NOISE</th> <th colspan="2">PEAK CUT</th> </tr> <tr> <th>MODE</th> <th></th> <th>(L1)</th> <th>(L2)</th> <th>(L3)</th> <th>(L4)</th> <th>(L5)</th> <th>(L6)</th> </tr> </thead> <tbody> <tr> <td>◆2</td> <td>●</td> <td>◆10</td> <td>◆1</td> <td>○</td> <td>○</td> <td>○</td> <td>●</td> </tr> </tbody> </table>	POWER	ERROR	PUMP DOWN	LOW NOISE			PEAK CUT		MODE		(L1)	(L2)	(L3)	(L4)	(L5)	(L6)	◆2	●	◆10	◆1	○	○	○	●
	POWER	ERROR	PUMP DOWN	LOW NOISE			PEAK CUT																			
MODE		(L1)	(L2)	(L3)	(L4)	(L5)	(L6)																			
◆2	●	◆10	◆1	○	○	○	●																			
○: Light OFF ●: Light ON ◆n: n times blinking																										

Detective Actuators: Discharge temperature thermistor	Detective details: "Protection stop by "discharge temperature > 239°F (115°C) during compressor operation"" generated 2 times within 24 hours.
---	--

Forecast of Cause:

1. 3-way valve not opened
2. EEV defective, strainer clogged
3. Outdoor unit operation failure, foreign matter on heat exchanger
4. Discharge temperature thermistor failure
5. Insufficient refrigerant

<Cooling operation>

Test 1 : Check if 3-way valve(gas side) is open.
 If the 3-way valve(gas side) was closed, open the 3-way valve(gas side) and check operation.

OK

Test 2 : Check the EEV, strainer
 EEV open?
 Strainer clogging check (before and after EEV, ACM oil return)
(SERVICE PARTS INFORMATION 3)

OK

Test 3 : Check the outdoor unit fan,heat exchanger
 Check for foreign object at heat exchanger
 Check if fan can be rotated by hand.
 Motor check **(SERVICE PARTS INFORMATION 5)**

OK

Test 4 : Check the discharge thermistor
 Discharger thermistor characteristics check (Check by disconnecting thermistor from PCB.)
 *For the characteristics of the thermistor, refer to the Trouble shooting 18.

OK

Test 5 : Check the refrigerant amount
 Leak check

<Heating operation>

Test 1 : Check if 3-way valve(liquid side) is open.
 If the 3-way valve(liquid side) was closed, open the 3-way valve(liquid side) and check operation.

OK

Test 2 : Check the EEV, strainer
 EEV open?
 Strainer clogging check (before and after EEV, ACM oil return)
(SERVICE PARTS INFORMATION 3)

OK

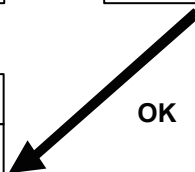

Trouble shooting 32 OUTDOOR UNIT Error Method: Compressor Temp. Error	Indicate of Display: Indoor Unit : Operation lamp : 10 times Flash, Timer lamp : 3 times Flash ERROR CODE : [E : A3]	Outdoor unit : <table border="1"> <tr> <td>POWER</td> <td>ERROR</td> <td>PUMP DOWN</td> <td colspan="3">LOW NOISE</td> <td colspan="3">PEAK CUT</td> </tr> <tr> <td>MODE</td> <td></td> <td>(L1)</td> <td>(L2)</td> <td>(L3)</td> <td>(L4)</td> <td>(L5)</td> <td>(L6)</td> <td></td> </tr> <tr> <td>◆2</td> <td>●</td> <td>◆10</td> <td>◆3</td> <td>○</td> <td>○</td> <td>○</td> <td>○</td> <td>●</td> </tr> </table>	POWER	ERROR	PUMP DOWN	LOW NOISE			PEAK CUT			MODE		(L1)	(L2)	(L3)	(L4)	(L5)	(L6)		◆2	●	◆10	◆3	○	○	○	○	●
	POWER	ERROR	PUMP DOWN	LOW NOISE			PEAK CUT																						
MODE		(L1)	(L2)	(L3)	(L4)	(L5)	(L6)																						
◆2	●	◆10	◆3	○	○	○	○	●																					
○: Light OFF ●: Light ON ◆n: n times blinking																													

Detective Actuators: Compressor temperature thermister	Detective details: Protection stop by "compressor temperature" > 230°F (110°C) during compressor operation" generated 2 times within 24 hours.
--	--

Forecast of Cause:

1. 3-way valve not opened
2. EEV defective, strainer clogged
3. Outdoor unit operation failure, foreign matter on heat exchanger
4. Compressor temperature thermistor failure
5. Insufficient refrigerant

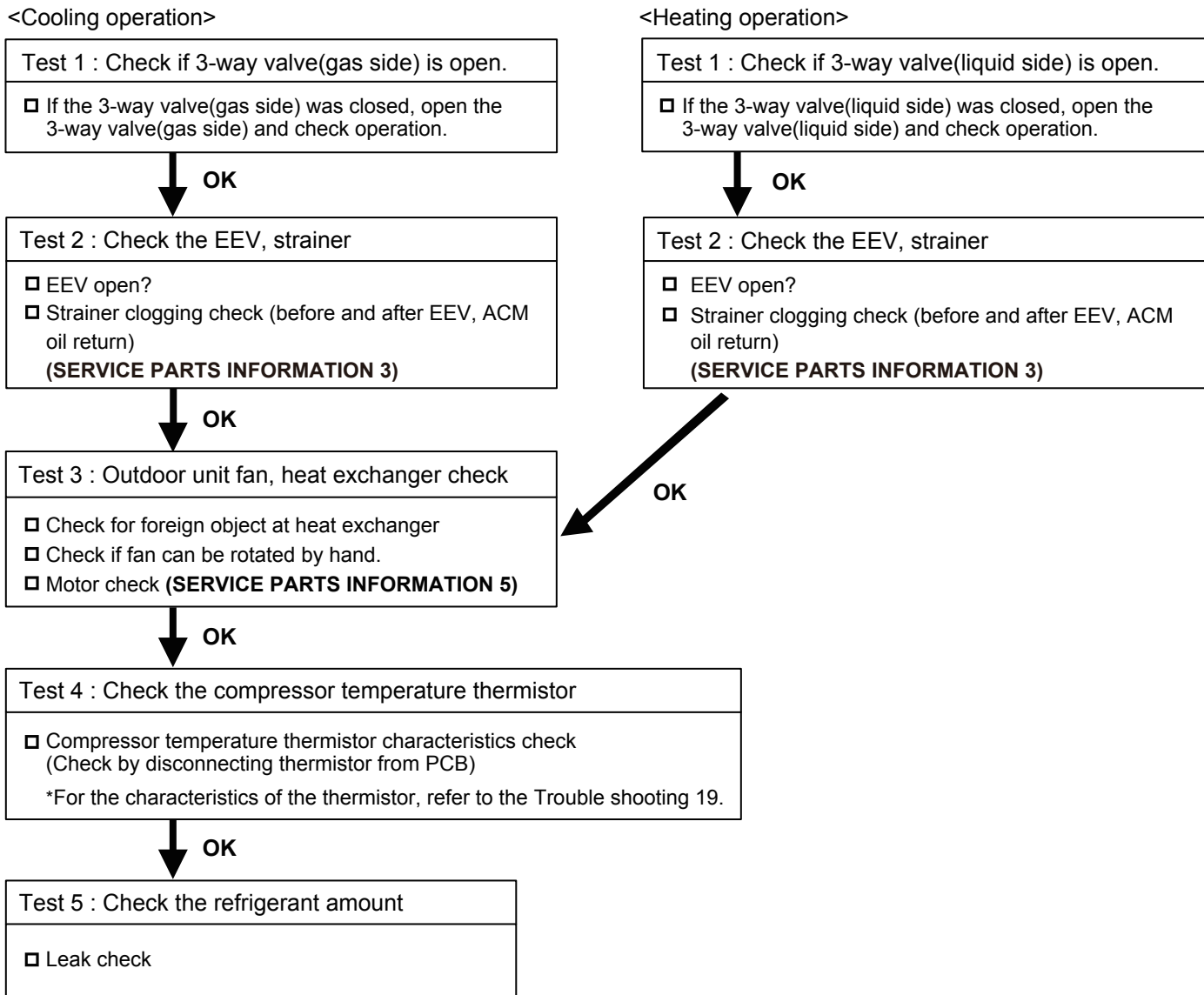

Trouble shooting 33 OUTDOOR UNIT Error Method: Low Pressure Error	Indicate of Display: Indoor Unit : Operation lamp: 10 times Flash, Timer lamp : 5 times Flash ERROR CODE : [E : A5]	Outdoor unit : <table border="1" style="width: 100%; border-collapse: collapse; text-align: center;"> <tr> <td>POWER</td> <td>ERROR</td> <td>PUMP DOWN</td> <td colspan="3">LOW NOISE</td> <td colspan="3">PEAK CUT</td> </tr> <tr> <td>MODE</td> <td></td> <td>(L1)</td> <td>(L2)</td> <td>(L3)</td> <td>(L4)</td> <td>(L5)</td> <td>(L6)</td> <td></td> </tr> <tr> <td>◆2</td> <td>●</td> <td>◆10</td> <td>◆5</td> <td>○</td> <td>○</td> <td>○</td> <td>○</td> <td>●</td> </tr> </table> <p>●: Light OFF ●: Light ON ◆n: n times blinking</p>	POWER	ERROR	PUMP DOWN	LOW NOISE			PEAK CUT			MODE		(L1)	(L2)	(L3)	(L4)	(L5)	(L6)		◆2	●	◆10	◆5	○	○	○	○	●
POWER	ERROR	PUMP DOWN	LOW NOISE			PEAK CUT																							
MODE		(L1)	(L2)	(L3)	(L4)	(L5)	(L6)																						
◆2	●	◆10	◆5	○	○	○	○	●																					

Detective Actuators: Pressure sensor	Detective details: “Protection stop by suction pressure < 0.02MPaG continued for 5 minutes” repeats 5 times within 2 hours.
--	---

Forecast of Cause:

1. 3-way valve not opened
2. Outdoor unit ambient temperature too low
3. Outdoor unit fan operation defective, foreign matter at heat exchanger
4. EEV defective, strainer clogged
5. Solenoid valve defective
6. Pressure sensor characteristics defective
7. Insufficient refrigerant

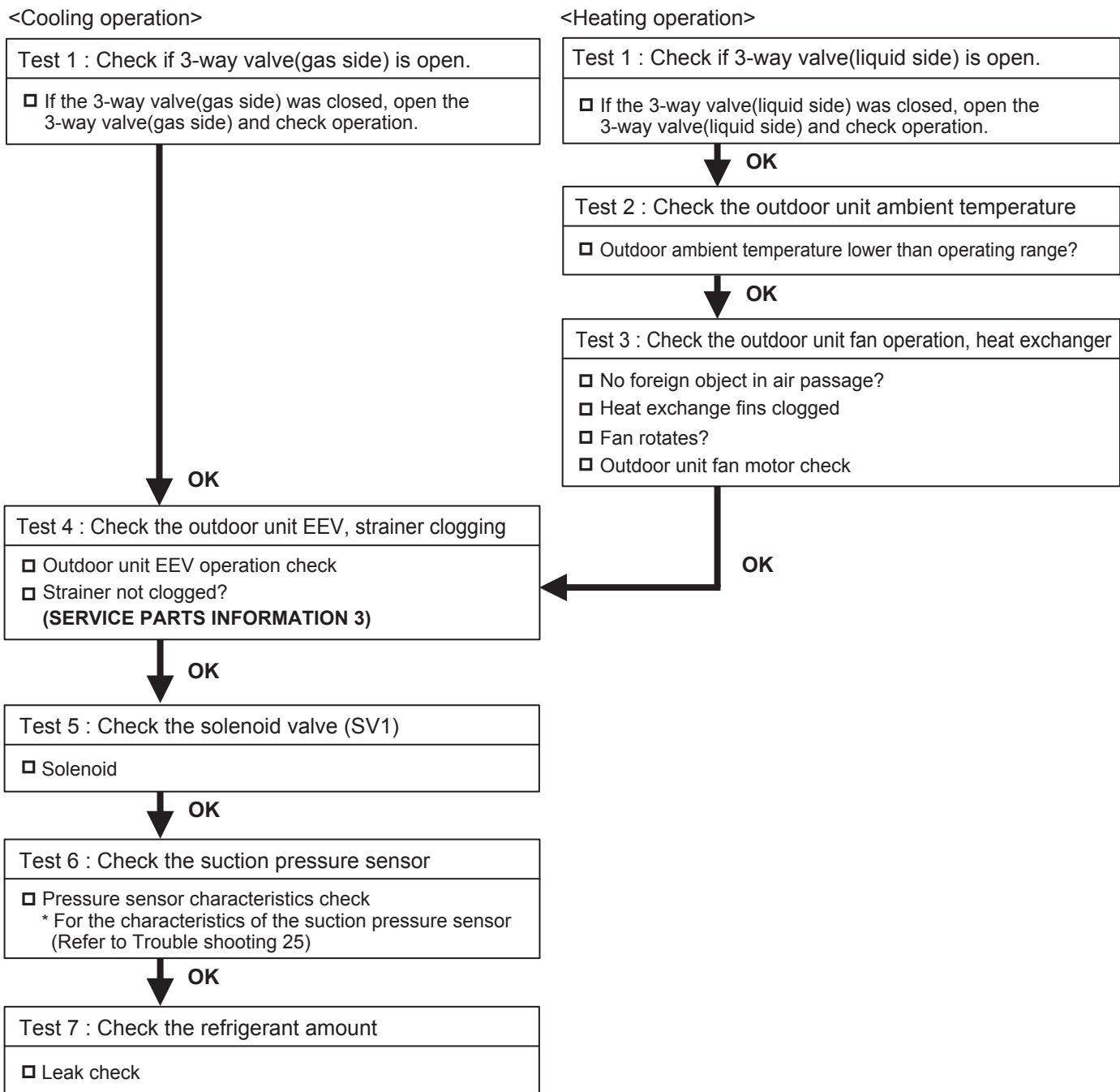

2-3 TROUBLE SHOOTING WITH NO ERROR CODE

Trouble shooting 34

Indoor Unit - No Power

Forecast of Cause:

1. Power Supply failure
2. External cause
3. Electrical Components defective

Test 1 : Check Installation Condition

- Isn't the breaker down?
- Check loose or removed connection cable.
- >> **If abnormal condition is found, correct it by referring to Installation Manual or Data & Technical Manual.**

OK

Test 2 : Check external cause at Indoor and Outdoor (Voltage drop or Noise)

- Instant drop ----- Check if there is a large load electric apparatus in the same circuit.
- Momentary power failure ----- Check if there is a defective contact or leak current in the power supply circuit.
- Noise ----- Check if there is any equipment causing harmonic wave near electric line. (Neon bulb or electric equipment that may cause harmonic wave)
Check the complete insulation of grounding.

OK

Test 3 : Check Electrical Components

- Check the voltage of power supply.
- >> **Check if AC187 - 253V appears at Outdoor Unit Terminal L - N.**



NO

YES

- Check Fuse in Filter PCB.
- >> **If Fuse is open, check if the wiring between Terminal and Filter PCB is loose, and replace Fuse.**
- Check Varistor in Filter PCB.
- >> **If Varistor is defective, there is a possibility of an abnormal power supply. Check the correct power supply and replace Varistor. Upon checking the normal power supply, replace Varistor.**

OK

► **If the symptom does not change by above Check 3, replace Main PCB.**

Trouble shooting 35

Outdoor Unit - No Power

Forecast of Cause:

1. Power Supply failure
2. External cause
3. Electrical Components defective

Test 1 : Check Installation Condition

- Isn't the breaker down?
- Check loose or removed connection cable.
- >> **If abnormal condition is found, correct it by referring to Installation Manual or Data & Technical Manual.**

OK

Test 2 : Check external cause at Indoor and Outdoor (Voltage drop or Noise)

- Instant drop ----- Check if there is a large load electric apparatus in the same circuit.
- Momentary power failure ----- Check if there is a defective contact or leak current in the power supply circuit.
- Noise ----- Check if there is any equipment causing harmonic wave near electric line.
(Neon bulb or electric equipment that may cause harmonic wave)
Check the complete insulation of grounding.

OK

Test 3 : Check Electrical Components

- Check the voltage of power supply.
>> **Check if AC187 - 253V appears at Outdoor Unit Terminal L - N.**

YES

- Check Fuse in Main PCB.
>> **If Fuse is open, check if the wiring between Terminal and Main PCB is loose, and replace Fuse.**

YES

- Check Active Filter Module and IPM. (SERVICE PARTS INFORMATION 6,7)
>> **If Active Filter Module or IPM is abnormal, replace it.**

OK

► **If the symptom does not change by above Check 3, replace Main PCB.**



NO

Trouble shooting 36

No Operation (Power is ON)

Forecast of Cause:

1. Setting/ Connection failure
2. External cause
3. Electrical Component defective

Test 1 : Check indoor and outdoor installation condition

- Indoor Unit - Check incorrect wiring between Indoor Unit - Remote Control.
Or, check if there is an open cable connection.
- Are these Indoor Unit, Outdoor Unit, and Remote Control suitable model numbers to connect?
>> If there is some abnormal condition, correct it by referring to Installation manual and Data & Technical Manual.

OK

Turn off Power and check/ correct followings.

- Is there loose or removed communication line of Indoor Unit and Outdoor Unit?

OK

Test 2 : Check external cause at Indoor and Outdoor (Voltage drop or Noise)

- Instant drop ----- Check if there is a large load electric apparatus in the same circuit.
- Momentary power failure ----- Check if there is a defective contact or leak current in the power supply circuit.
- Noise ----- Check if there is any equipment causing harmonic wave near electric line.
(Neon bulb or electric equipment that may cause harmonic wave)
Check the complete insulation of grounding.

OK

Test 3 : Check Wired Remote Controller and Controller PCB

- Check Voltage at CN12 of Controller PCB. (terminal 1-2)
(Power supply to Remote Control)

- >> If it is DC12V, Remote Control is failure. (Controller PCB is normal) >> Replace Remote Control**
- >> If it is DC 0V, Controller PCB is failure. (Check Remote Control once again) >> Replace Controller PCB**
- >> If the symptom does not change by above Check 1, 2, 3, replace Main PCB of Outdoor unit.**

DC



Trouble shooting 37

No Cooling / No Heating

Forecast of Cause:

1. Indoor Unit error
2. Outdoor Unit error
3. Effect by Surrounding environment
4. Connection Pipe / Connection Wire failure
5. Refrigeration cycle failure

Test 1 : Check Indoor Unit

- Does Indoor Unit FAN run on HIGH FAN?
- Is Air Filter dirty?
- Is Heat Exchanger clogged?
- Check if Energy save function is operated.



Test 2 : Check Outdoor Unit Operation

- Check if Outdoor Unit is operating
- Check any objects that obstruct the air flow route.
- Check clogged Heat Exchanger.
- Is the Valve open?



Test 3 : Check Site Condition

- Is capacity of Indoor Unit fitted to Room size?
- Any windows open? Or direct sunlight ?



Test 4 : Check Indoor/ Outdoor Installation Condition

- Check connection pipe (specified pipe length & Pipe diameter?)
- Check any loose or removed communication line.
- >> **If there is an abnormal condition, correct it by referring to Installation Manual or Data & Technical Manual.**



Test 5 : Check Refrigeration Cycle

- Check if Strainer is clogged (Refer to the figure at right).
- Measure Gas Pressure and if there is a leakage, correct it.
- >> **When recharging the refrigerant, make sure to perform vacuuming, and recharge the specified amount.**
- Check Compressor (SERVICE PARTS INFORMATION 1,2)
- Check EEV (SERVICE PARTS INFORMATION 3)
- Check Heater unit (SERVICE PARTS INFORMATION 3)

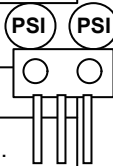

Attention

Strainer normally does not have temperature difference between inlet and outlet as shown in ①, but if there is a difference like shown in ②, there is a possibility of inside clogged. In this case, replace Strainer.

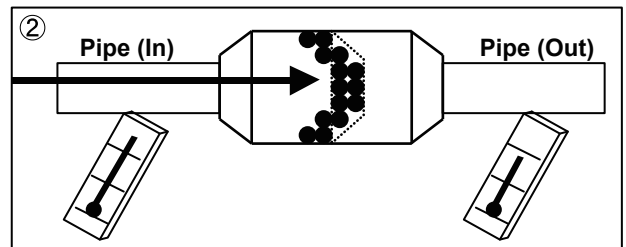
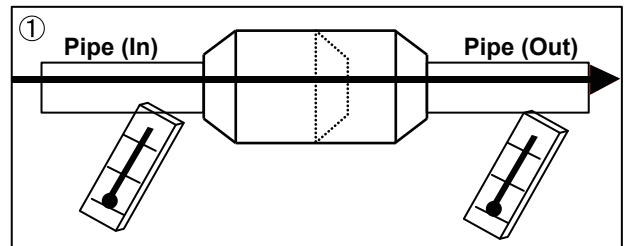

Trouble shooting 38

Abnormal Noise

Forecast of Cause :

1. Abnormal installation (Indoor/ Outdoor)
2. Fan failure (Indoor/ Outdoor)
3. Compressor failure (Outdoor)

Diagnosis method when Abnormal Noise is occurred

- Abnormal noise is coming from Indoor Unit.
(Check and correct followings)

- Is Main Unit installed in stable condition?
- Is the installation of Air suction grille and front panel normal?

OK

- Is Fan broken or deformed?
- Is the screw of Fan loose?
- Is there any object which obstruct the Fan rotation?

- Abnormal noise is coming from Outdoor Unit.
(Check and correct followings)

- Is Main Unit installed in stable condition?
- Is Fan Guard installed normally?

OK

- Is Fan broken or deformed?
- Is the screw of Fan loose?
- Is there any object which obstruct the Fan rotation?

OK

- Check if vibration noise by loose bolt or contact noise of piping is happening.

OK

- Is Compressor locked?
>> Check Compressor
(SERVICE PARTS INFORMATION 1,2)

Trouble shooting 39

Water Leaking

Forecast of Cause:

1. Erroneous installation
2. Drain hose failure

Diagnosis method when water leak occurs

- Is Main Unit installed in stable condition?
- Is Main Unit broken or deformed at the time of transportation or maintenance?

OK

- Is Drain Hose connection loose?
- Is there a trap in Drain Hose?
- Is Drain Hose clogged?

OK

- Is Fan rotating?

Diagnosis method when water is spitting out.

- Is the filter clogged?

OK

- Check Gas Pressure and correct it if there was a gas leak.

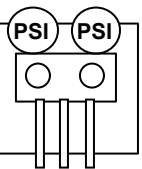

Trouble shooting 40
Too Warm

Forecast of Cause :

1. House insulation setting has not been changed.
2. Temperature sensing location has not been changed.
3. Installation location of the wired remote.
4. Function settings have not been changed.

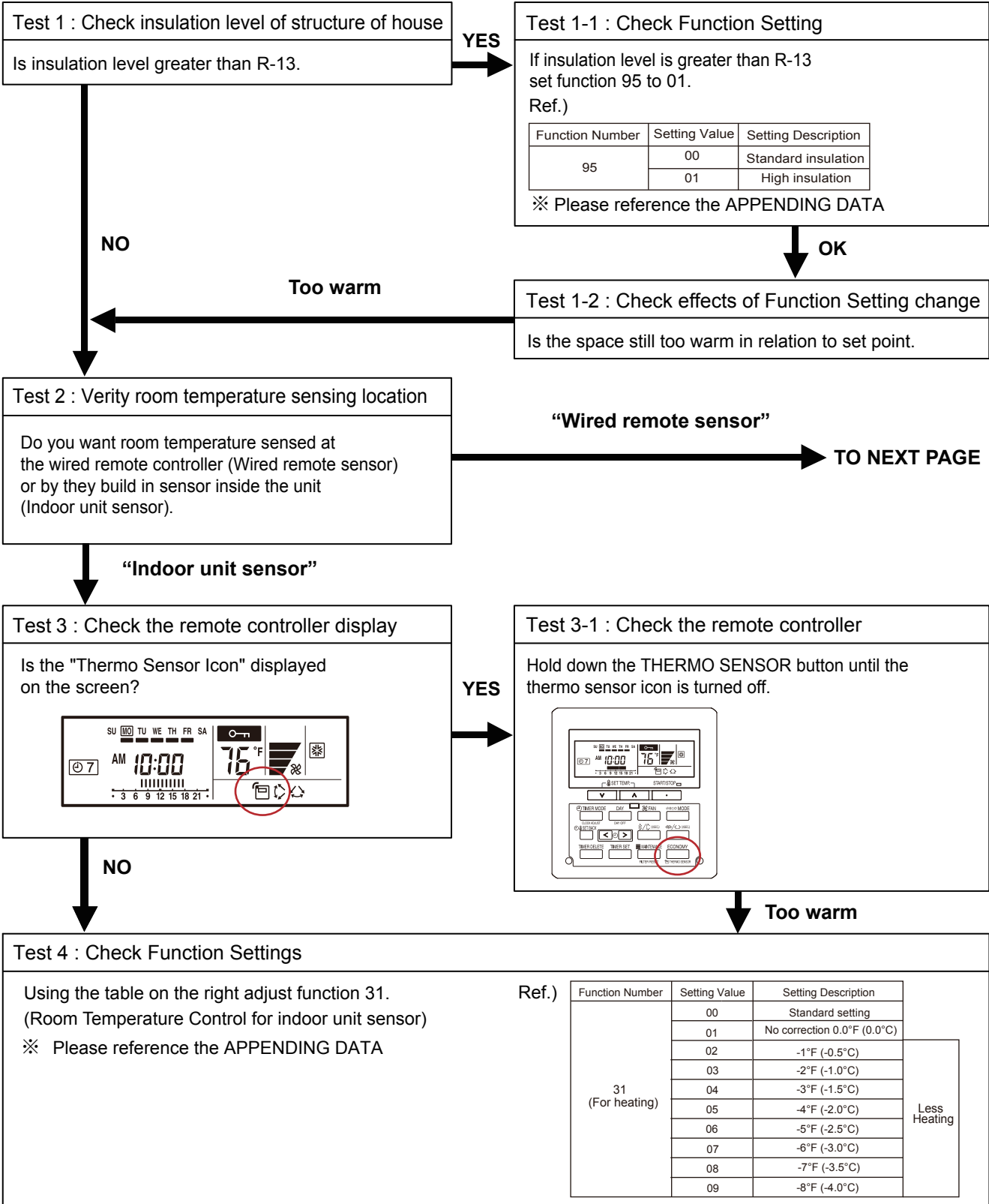

“Wired remote sensor”

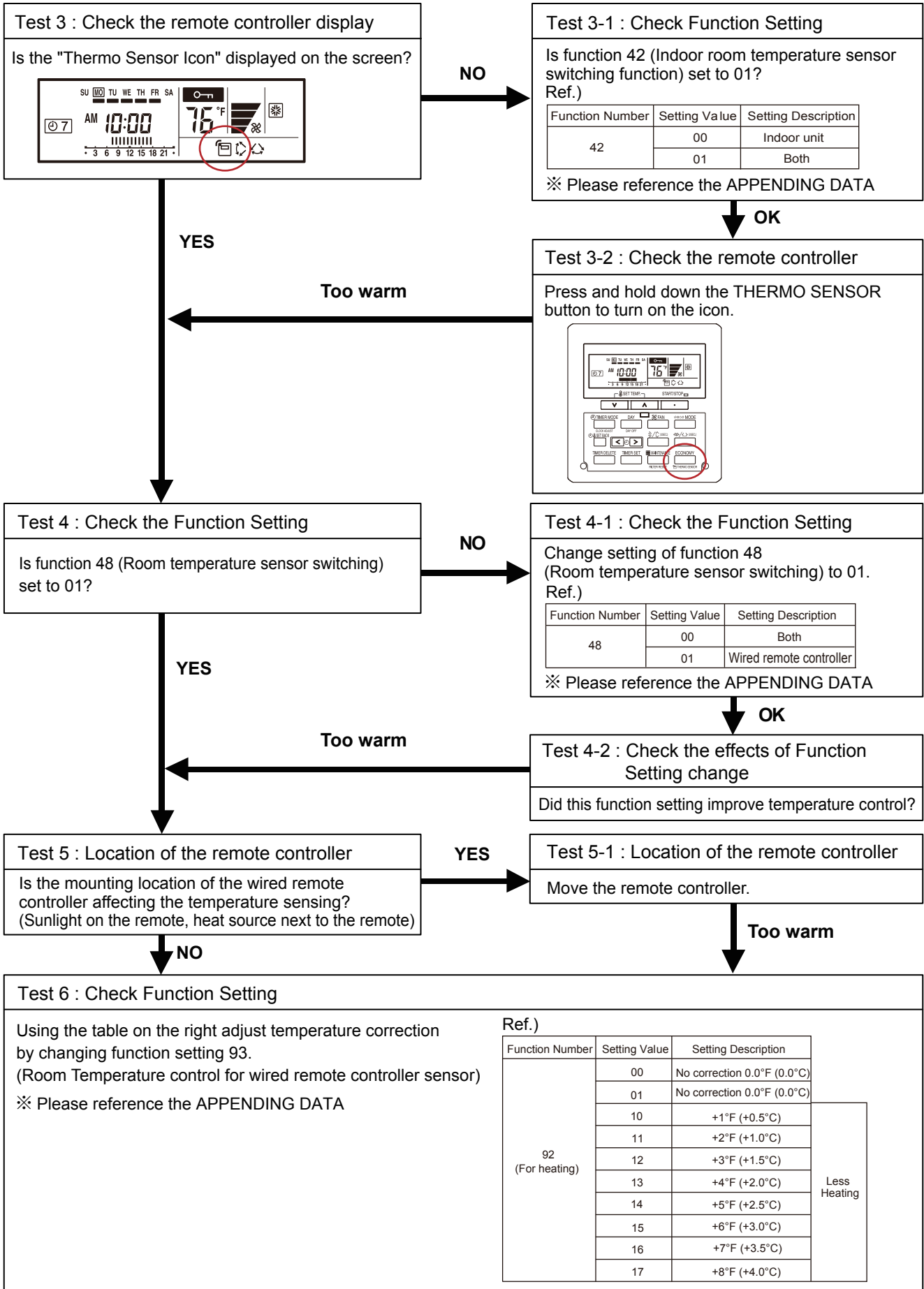

Trouble shooting 41
Too Cool

Forecast of Cause :

1. House insulation setting has not been changed.
2. Temperature sensing location has not been changed.
3. Installation location of the wired remote.
4. Function settings have not been changed.

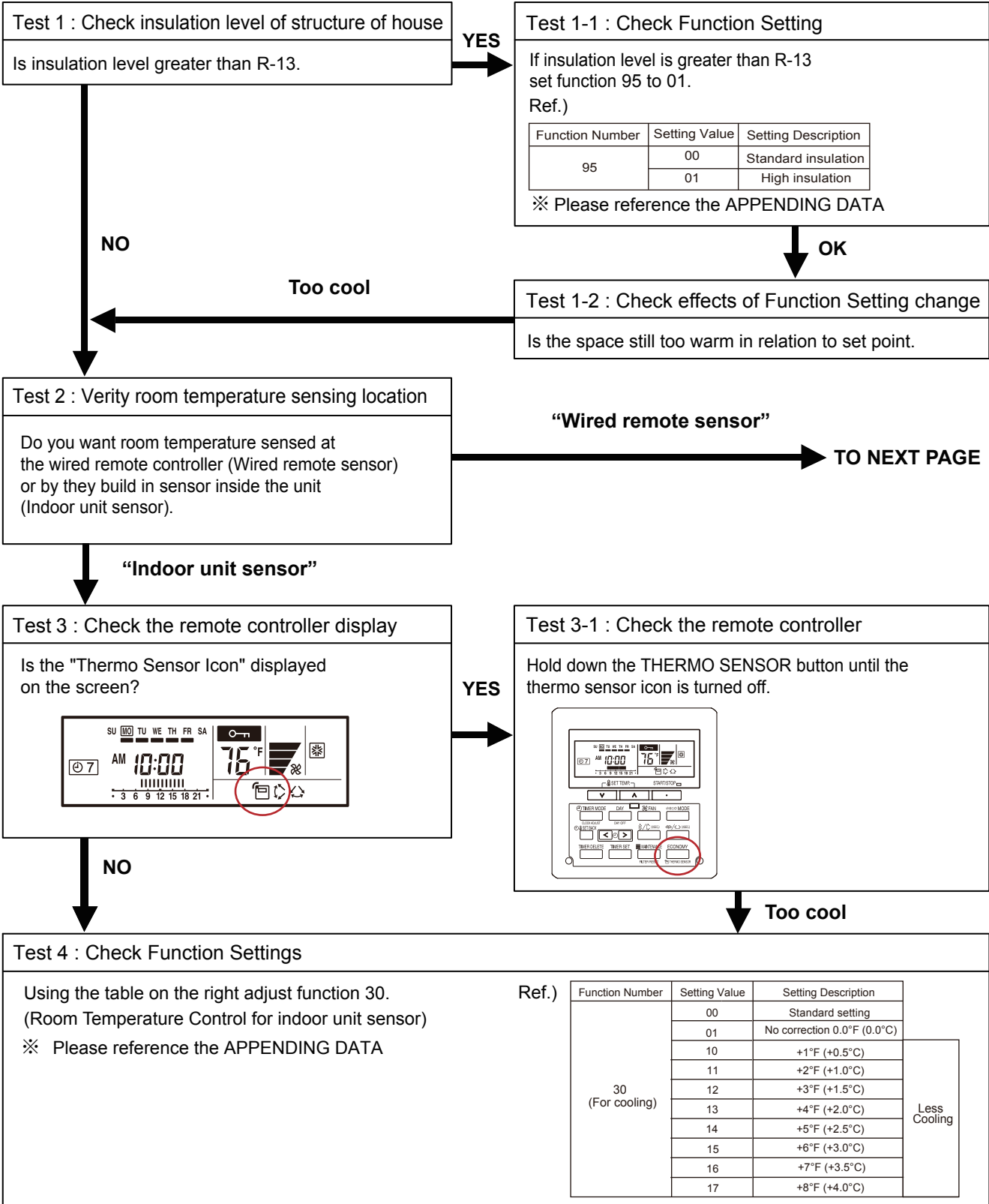

“Wired remote sensor”

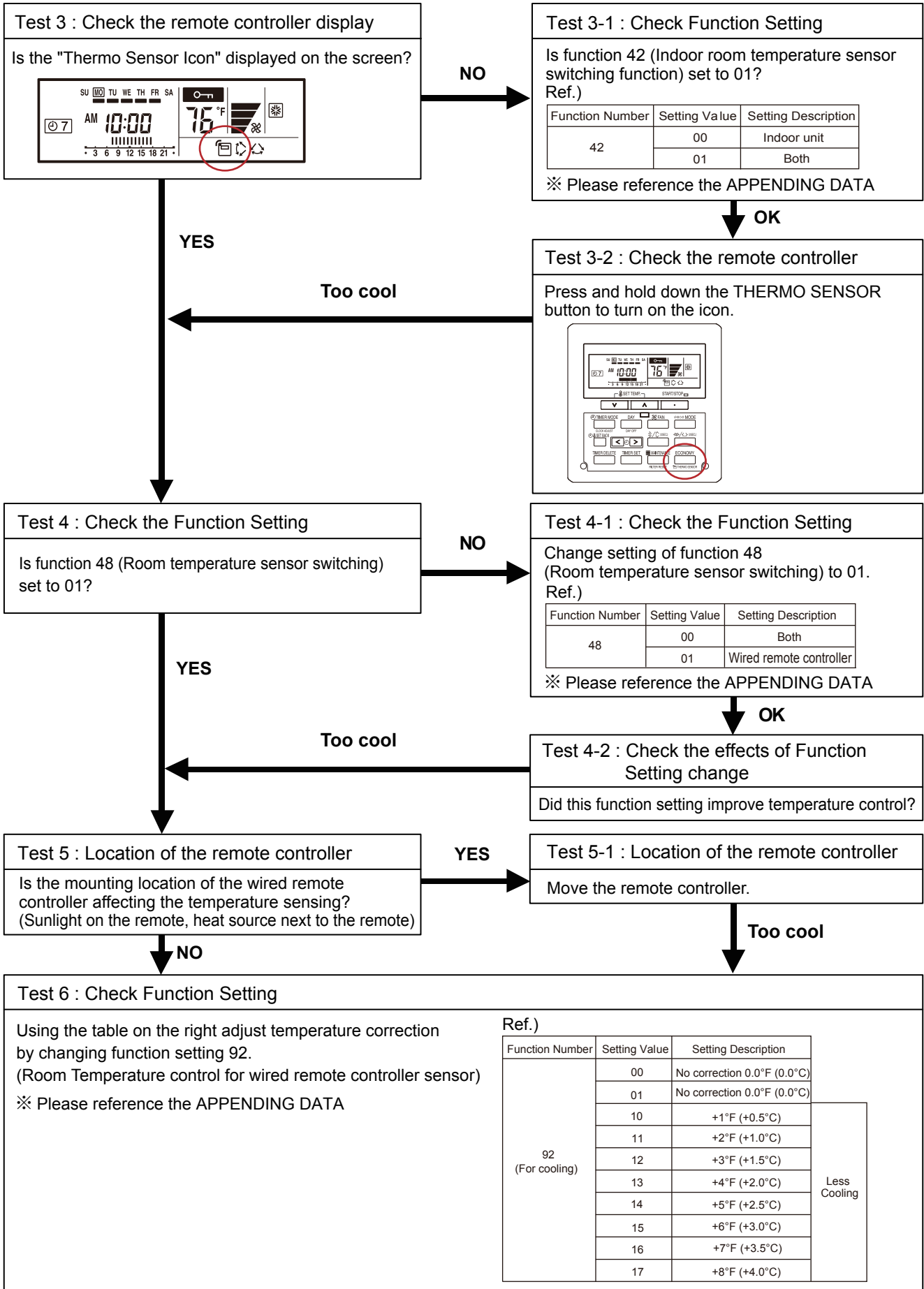

2-4 SERVICE PARTS INFORMATION

SERVICE PARTS INFORMATION 1

Compressor

Diagnosis method of Compressor (If Outdoor Unit LED displays Error, refer to Trouble shooting)

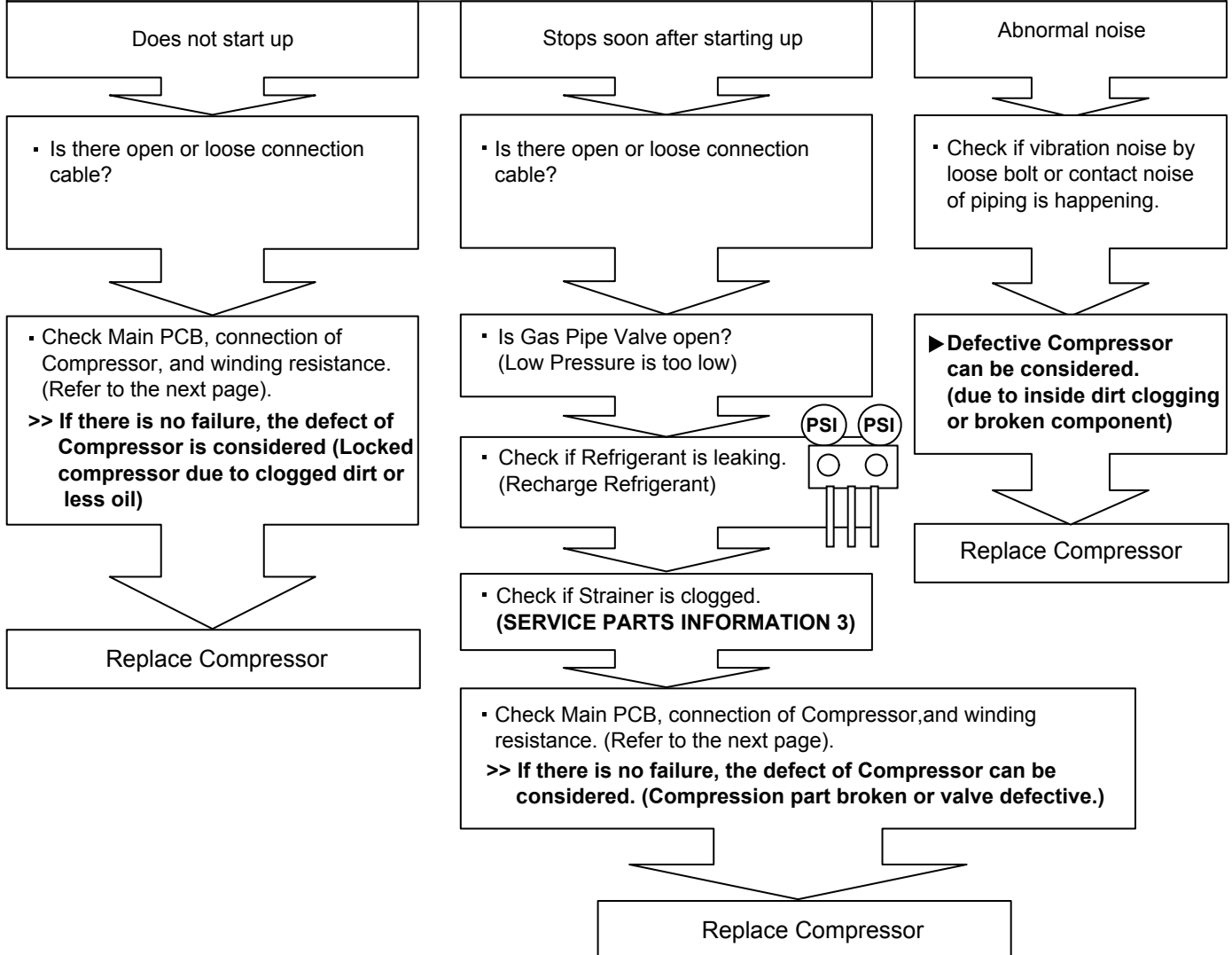

SERVICE PARTS INFORMATION 2

Inverter Compressor

Test 1 : Check Connection

- Check terminal connection of Compressor (loose or incorrect wiring)

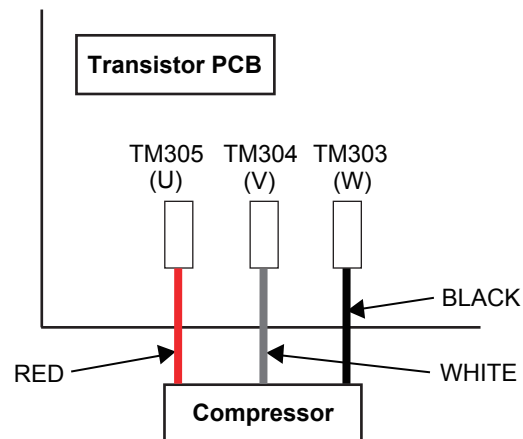
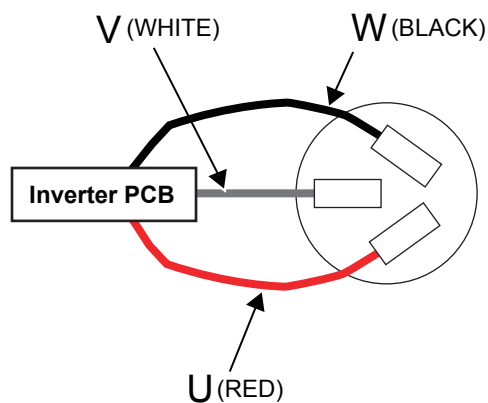

Test 2 : Check Winding Resistance

- Check winding resistance of each terminal
▶ **If the resistance value is 0Ω or infinite, replace Compressor.**

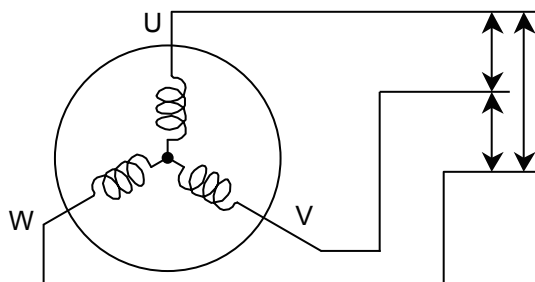

Resistance Value :
0.24Ω at 68°F(20°C)



Test 3 : Replace Main PCB

- ▶ **If the symptom does not change with above Check 1, 2, replace Main PCB.**

SERVICE PARTS INFORMATION 3

Outdoor unit Electronic Expansion Valve (EEV)

Test 1 : Check Connections

- Check connection of connector (Loose connector or open cable)

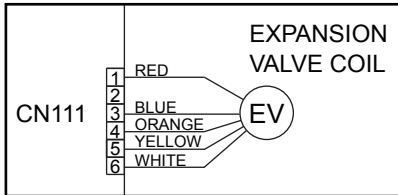

Test 2 : Check Coil of EEV

- Remove connector, check each winding resistance of Coil.

Read wire	Resistance value
White - Red	$46 \Omega \pm 4 \Omega$ at 68°F(20°C)
Yellow - Red	
Orange - Red	
Blue - Red	

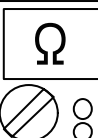

► **If Resistance value is abnormal, replace EEV.**

Test 3 : Check Noise at start up

- Turn on Power and check operation noise.
- **If an abnormal noise does not show, replace Main PCB.**

Test 4 : Check Voltage from Main PCB.

- Remove Connector and check Voltage (DC12V)
- **If it does not appear, replace Main PCB.**



Test 5 : Check Opening and Closing Operation of Valve

When Valve is closed, it has a temp. difference between Inlet and Outlet.

CLOSE
Example : Hot Gas

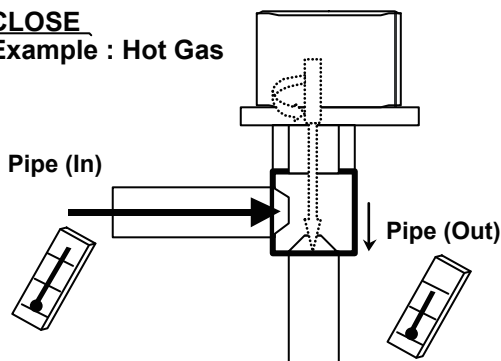

If it is open, it has no temp. difference between Inlet and Outlet.

OPEN
Example : Hot Gas

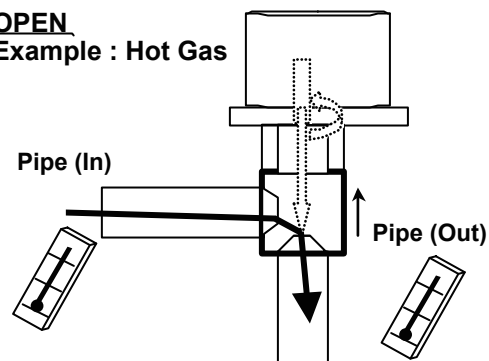

Test 6 : Check Strainer

Strainer normally does not have temperature difference between inlet and outlet as shown in ①, but if there is a difference as shown in ②, there is a possibility of inside clogged. In this case, replace Strainer.

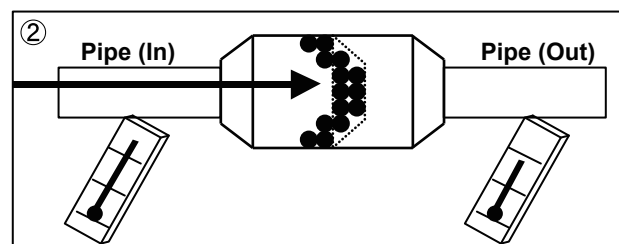
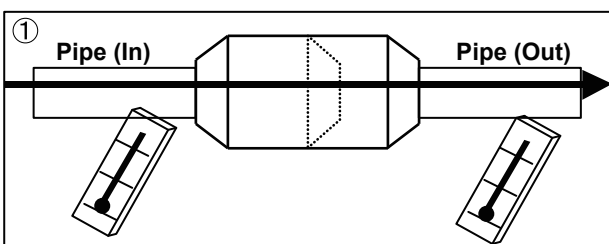

SERVICE PARTS INFORMATION 4

Indoor unit fan motor

Test 1 : Check rotation of Fan

- Rotate the fan by hand when operation is off.
(Check if fan is caught, dropped off or locked motor)
- >>If Fan or Bearing is abnormal, replace it.**

Test 2 : Check resistance of indoor fan motor

- Refer to below. Circuit-test "Vm" and "GND" terminal.
(Vm: DC voltage, GND: Ground terminal)
- >>If they are short-circuited (below 300 k Ω), replace Indoor fan motor and Controller PCB.**

Pin number (wire color)	Terminal function (symbol)
1 (Red)	DC voltage (Vm)
2	No function
3	No function
4 (Black)	Earth terminal (GND)
5 (White)	Control voltage (Vcc)
6 (Yellow)	Speed command (Vsp)
7 (Brown)	Feed back (FG)

SERVICE PARTS INFORMATION 5

Outdoor unit fan motor

Test 1 : Check rotation of Fan

- Rotate the fan by hand when operation is off.
(Check if fan is caught, dropped off or locked motor)
- >>If Fan or Bearing is abnormal, replace it.**

Test 2 : Check resistance of Outdoor Fan Motor 1 or 2

- Refer to below. Circuit-test "Vm" and "GND" terminal.
(Vm: DC voltage, GND: Earth terminal)
- >>If they are short-circuited (below 300 k Ω), replace Outdoor fan motor and Main PCB.**

Pin number (wire color)	Terminal function (symbol)
1 (Red)	DC voltage (Vm)
2	No function
3 (Black)	Earth terminal (GND)
4 (White)	Control voltage (Vcc)
5 (Yellow)	Speed command (Vsp)
6 (Brown)	Feed back (FG)

SERVICE PARTS INFORMATION 6

Heater unit

Test 1 : Check Connections

- Check connection of connector
(Loose connector or open cable)

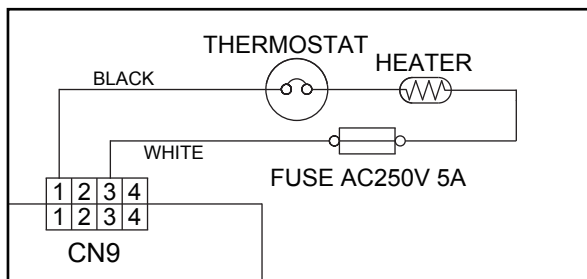

Test 2 : Check electrical components

- Check Check Fuses.
>> If Fuse is open, check connection, and replace Fuse.

Test 3 : Check Heater wire.

- Remove connector, check resistance of Heater wire.

	Resistance value R
Black - White	320.7 - 367.3 Ω at 77°F (25°C)

- **If Resistance value is abnormal, replace Heater Unit.**

SERVICE PARTS INFORMATION 7

Active filter module

Test 1 : Check Open or Short-circuit and Diode (D1)

• Remove connector, check the open or short-circuit and the diode in the module

Check the open or short-circuit

Table.1 Each type standard value

Terminal		Resistance value	
		Type A	Type B
multimeter (+)	multimeter (-)	SACT32010 [HITACHI] LACT33020 [HITACHI]	PM-604 [FGEL] PM-703 [FGEL]
		PM-601 [FGEL] LOT No. - 1302931395	PM-601 [FGEL] LOT No. 1302931396 -
+ (+IN)*	- (-IN)*	360kΩ ± 20%	360kΩ ± 20%
- (-IN)*	N1 (N)*	0 Ω	0 Ω
※ P	+ (+IN)*	720kΩ ± 20%	900kΩ ± 20%
L1	L2	1.01MΩ / 0.76MΩ (Ref. value 1) (Ref. value 2)	1.01MΩ / 0.76MΩ (Ref. value 1) (Ref. value 2)
P	N1 (N)*	360kΩ ± 20%	540kΩ ± 20%
L1, L2	Control Box	∞ Ω	∞ Ω
※ L2	N1 (N)*	1.65MΩ / 1.14MΩ (Ref. value 1) (Ref. value 2)	1.65MΩ / 1.14MΩ (Ref. value 1) (Ref. value 2)

* () is FGEL terminal name.

Table.2 Standard value is changed by the tool specification
(Type A and B are the same value)

Terminal		Resistance value
multimeter (+)	multimeter (-)	
※ L2	P	1.32MΩ / 0.66MΩ (Ref. value 1) (Ref. value 2)
※ P	L2	1.01MΩ / 0.76MΩ (Ref. value 1) (Ref. value 2)

※ By kind of multimeter , the value may change significantly.

Ref. value 1

Specifications for Multimeter
Manufacturer : FLUKE
Model name : FLUKE11
Power source : DC9V.

Ref. value 2

Specifications for Multimeter
Manufacturer : SANWA
Model name : PM3
Power source : DC3V.

► **If it is abnormal,replace ACTIVE FILTER MODULE**

LOT No. of PM-601 [FGEL] type

Label position

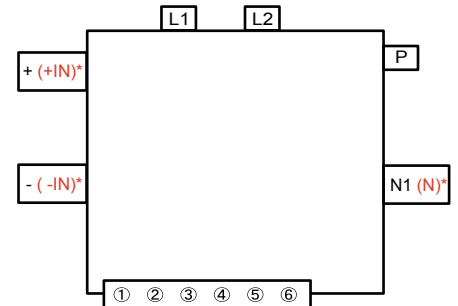
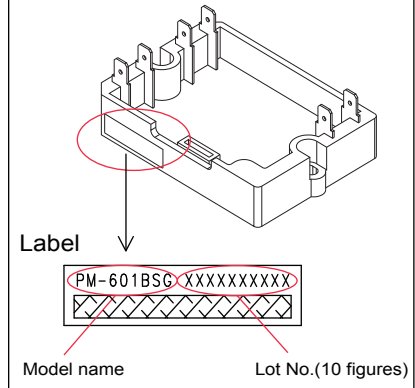

Test 2 : Check the Output DC voltage (between P and N)

• Check the Output DC voltage (between P and N) of compressor stopping and operating.

>> If the output voltage of compressor operating is less than the output voltage of compressor stopping, Active Filter Module is defective. >> **Replace Active Filter Module**

SERVICE PARTS INFORMATION 8

IPM
(Mounted on Transistor PCB)

Test 1 : Check the Transistor of PCB (for Resistance)

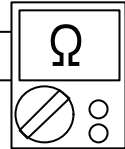

- ① Disconnect the connection wires between the Transistor PCB - Capacitor PCB and Transistor PCB - Inverter Compressor.
- ② Set the tester to the "Resistance" mode, and measure the resistance between the following terminals.
 TM301 (P) - TM305(U) / TM304(V) / TM303(W)
 TM302 (N) - TM305(U) / TM304(V) / TM303(W)
- ③ Judge the result of ② as follows:

Terminal		Resistance value
Tester(+)	Tester(-)	
P	U	Over 2kΩ (Including ∞Ω)
P	V	
P	W	
U	P	Over 20kΩ (Including ∞Ω)
V	P	
W	P	
N	U	
N	V	Over 2kΩ (Including ∞Ω)
N	W	
U	N	
V	N	Over 2kΩ (Including ∞Ω)
W	N	

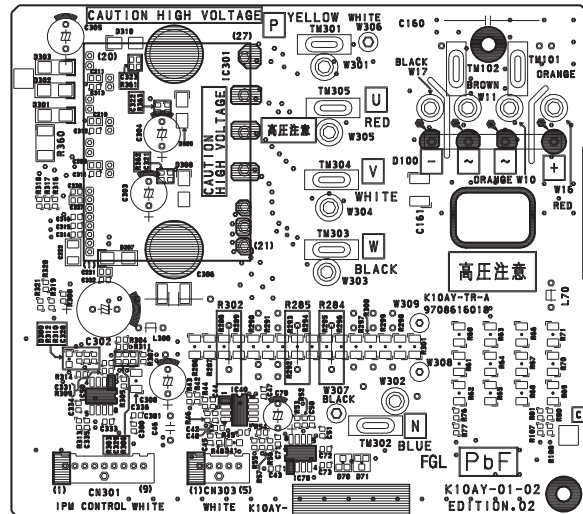

Test 2 : Check the Transistor of PCB (for Diode)

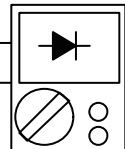

- ④ Set the tester to the "Diode" mode, and measure the voltage value between the following terminals.
- ⑤ Judge the result of ④ as follows:

Terminal		Tester display
Tester(+)	Tester(-)	
P	U	∞
P	V	
P	W	
U	P	0.3V ~ 0.7V
V	P	
W	P	
N	U	
N	V	∞
N	W	
U	N	
V	N	∞
W	N	

WALL MOUNTED type INVERTER

3 . APPENDING DATA

3-1. FUNCTION SETTING

3-1-1 INDOOR UNIT

- Follow the instructions in the Local Setup Procedure, which is supplied with the remote control, in accordance with the installed condition.
After the power is turned on, perform the Function Setting on the remote control.
- The settings may be selected between the following two: Function Number or Setting Value.
- Settings will not be changed if invalid numbers or setting values are selected.

Function Details

1-1. Setting the Filter sign

Select appropriate intervals for displaying the filter sign on the indoor unit according to the estimated amount of dust in the air of the room.
If the indication is not required, select "No indication" (03).

(◆ . . . Factory setting)

Function Number	Setting Value	Setting Description
11	00	Standard (400 hours)
	01	Long interval (1000 hours)
	02	Short interval (200 hours)
	03	No indication

1-2. Setting the Auto restart

Enable or disable automatic restart after a power interruption.

(◆ . . . Factory setting)

Function Number	Setting Value	Setting Description
40	00	Enable
	01	Disable

Auto restart is an emergency function such as for power outage etc.
Do not attempt to use this function in normal operation.
Be sure to operate the unit by remote controller or external device.

1-3. Setting the Room temperature sensor switching (Only for Wired remote controller)

When using the Wired remote controller temperature sensor , change the setting to "Both" (01).

(◆ . . .Factory setting)

Function Number	Setting Value	Setting Description
42	00	Indoor unit
	01	Both

00: Sensor on the indoor unit is active.

01: Sensors on both indoor unit and wired remote controller are active.

- Remote controller sensor must be turned on by using the remote controller.

1-4. Setting the Remote controller custom code (Only for wireless remote controller)

The indoor unit custom code can be changed.

Select the appropriate custom code.

(◆ . . .Factory setting)

Function Number	Setting Value	Setting Description
44	00	A
	01	B
	02	C
	03	D

1-5. Setting the External input control

"Operation / Stop" mode or "Forced stop" mode can be selected.

(◆ . . .Factory setting)

Function Number	Setting Value	Setting Description
46	00	Operation / Stop mode 1
	01	(Setting prohibited)
	02	Forced stop mode
	03	Operation / Stop mode 2

1-6. Setting the Room temperature sensor switching (Aux.)

To use the temperature sensor on the wired remote controller only, change the setting to "Wired remote controller" (01).

This function will only work if the function setting 42 is set at "Both" (01)

When the setting value is set to "Both"(00),more suitable control of the room temperature by setting function setting 30 and 31 too.

(◆ . . .Factory setting)

Function Number	Setting Value	Setting Description
48	00	Both
	01	Wired remote controller

1-7. Setting the Indoor unit fan control for energy saving for cooling

Enables or disables the power-saving function by controlling the indoor unit fan rotation when the outdoor unit is stopped during cooling operation.

(◆ . . .Factory setting)

Function Number	Setting Value	Setting Description
49	00	Disable
	01	Enable
	02	Remote controller ◆

00: When the outdoor unit is stopped, the indoor unit fan operates continuously following the setting on the remote controller.

01: When the outdoor unit is stopped, the indoor unit fan operates intermittently at a very low speed.

02: Enable or disable this function by remote controller setting.

*When using a wired remote controller without Indoor unit fan control for energy saving for cooling function, or when connecting a single split converter, the setting cannot be made by using the remote controller. Set to "00" or "01".

To confirm if the remote controller has this function, refer to the operating manual of each remote controller.

1-8 . Setting the Switching function for external output terminal

Functions of the external output terminal can be switched.

For details. refer to "External input and output".

(◆ . . .Factory setting)

Function Number	Setting Value	Setting Description
60	00	Operation status ◆
	01-08	Other status (refer to Design & Technical manual)
	09	Error status
	10	Indoor unit fan operation status

1-9 . Setting the Server room control switching

Switches between normal control and server room control.

To use this function, address setting of the primary unit and secondary unit needs to be done.

(◆ . . .Factory setting)

Function Number	Setting Value	Setting Description
96	00	Nromal control ◆
	01	Server room control (Primary unit)
	02	Server room control (Secondary unit)

Temperature Correction

When changing Function 95, perform this setting before other Room temp. control settings (Function 30, 31, 35, 36).

If Function 95 is not set first, Room temperature control settings (Function 30, 31, 35, 36) will be reset and you must redo them again.

1-10. Setting the Heat Insulation condition (building insulation)

Heat insulation conditions differ according to the installed environment.

Standard insulation "00" allows system to rapidly respond to the cooling or heating load changes. High insulation "01" is when the heat insulation structure of the building is high and does not require system to rapidly respond to cooling or heating load changes. When High insulation "01" is selected;

- Overheating (overcooling) is prevented at the start-up.
- All room temp. control settings (Function 30, 31, 35, 36) will reset to No correction [0.0°F (0.0°C)].

◆ . . . Factory setting)

Function Number	Setting Value	Setting Description
95	00	Standard insulation ◆
	01	High insulation

1-11. Setting the Room temperature control for indoor unit sensor

Depending on the installed environment, correction of the room temperature sensor may be required.

Select the appropriate control setting according to the installed environment.

The temperature correction values show the difference from the Standard setting "00" (manufacturer's recommended value).

- When Function 95-01(High insulation) is set, the Standard setting "00" will be the same as No correction "01" [0.0°F(0.0°C)].

◆ . . . Factory setting)

Function Number	Setting Value	Setting Description		
30 (For cooling)	31 (For heating)	00	Standard setting ◆	
		01	No correction 0.0°F (0.0°C)	
		02	-1°F (-0.5°C)	More Cooling Less Heating
		03	-2°F (-1.0°C)	
		04	-3°F (-1.5°C)	
		05	-4°F (-2.0°C)	
		06	-5°F (-2.5°C)	
		07	-6°F (-3.0°C)	
		08	-7°F (-3.5°C)	
		09	-8°F (-4.0°C)	Less Cooling More Heating
		10	+1°F (+0.5°C)	
		11	+2°F (+1.0°C)	
		12	+3°F (+1.5°C)	
		13	+4°F (+2.0°C)	
		14	+5°F (+2.5°C)	
		15	+6°F (+3.0°C)	
		16	+7°F (+3.5°C)	
17	+8°F (+4.0°C)			

1-12. Setting the Room temperature control for wired remote controller sensor

Depending on the installed environment, correction of the wire remote temperature sensor may be required. Select the appropriate control setting according to the installed environment. To change this setting, set Function 42 to Both "01". Ensure that the Thermo Sensor icon is displayed on the remote controller screen.

(◆ . . . Factory setting)

Function Number		Setting Value	Setting Description	
35 (For cooling)	36 (For heating)	00	No correction 0.0°F (0.0°C)	◆
		01	No correction 0.0°F (0.0°C)	
		02	-1°F (-0.5°C)	More Cooling Less Heating
		03	-2°F (-1.0°C)	
		04	-3°F (-1.5°C)	
		05	-4°F (-2.0°C)	
		06	-5°F (-2.5°C)	
		07	-6°F (-3.0°C)	
		08	-7°F (-3.5°C)	
		09	-8°F (-4.0°C)	
		10	+1°F (+0.5°C)	Less Cooling More Heating
		11	+2°F (+1.0°C)	
		12	+3°F (+1.5°C)	
		13	+4°F (+2.0°C)	
		14	+5°F (+2.5°C)	
		15	+6°F (+3.0°C)	
		16	+7°F (+3.5°C)	
		17	+8°F (+4.0°C)	

3-1-2 PROCEDURES TO CHANGE THE FUNCTION SETTING FOR WIRELESS RC

- This procedure changes to the function settings used to control the indoor unit according to the installation conditions. Incorrect settings can cause the indoor unit malfunction.
- After perform the "FUNCTION SETTING" according to the installation conditions using the remote controller.
- Settings will not be changed if invalid numbers or setting values are selected.

Entering the Function Setting Mode

- While pressing the POWERFUL button and SET TEMP.(^) button simultaneously, press the RESET button to enter the function setting mode.

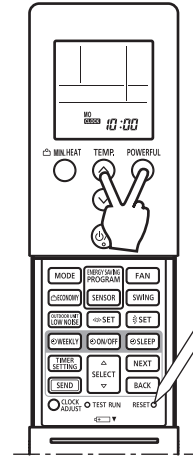

Selecting the Function Number and Setting Value

- (1) Press the SET TEMP.(^)(v) buttons to select the function number.
(Press the MIN. HEAT button to switch between the left and right digits.)

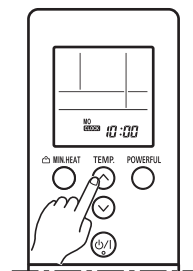

- (2) Press the POWERFUL button to proceed to setting the value.
(Press the POWERFUL button again to return to the function number selection.)
- (3) Press the SET TEMP.(^)(v) buttons to select the setting value.
(Press the MIN. HEAT button to switch between the left and right digits.)

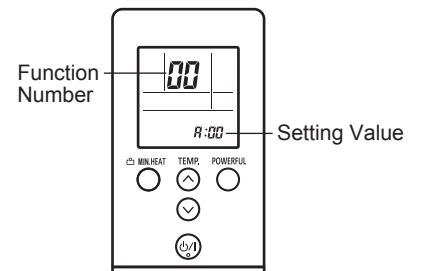

- (4) Press the MODE button, in the order listed to confirm the setting.
Please confirm that the beep sounds.
- (5) Next, please press the START/STOP(⏻/⏹) button.
Please confirm that the beep sounds.

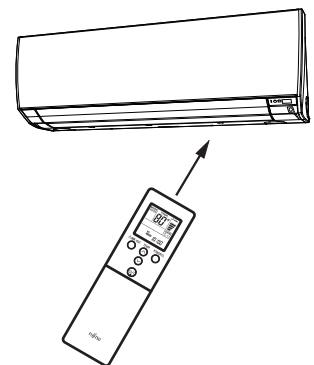

- (6) Press the RESET button to cancel the function setting mode.
- (7) After completing the FUNCTION SETTING, be sure to disconnect the power and connect it again.

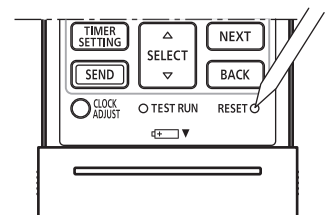

⚠ CAUTION

After disconnect the power, wait 10 seconds or more before connect it again.
The FUNCTION SETTING doesn't become active unless the power is disconnect the reconnected again.

3-1-3 Procedures to change the Function Setting

This procedure changes the function settings used to control the indoor unit according to the installation conditions. Incorrect settings can cause the indoor unit to malfunction. Perform the “Function Setting” according to the installation conditions using the remote controller.

- Refer to the indoor unit installation manual for details on the function numbers and setting numbers, before the start of function setting.

1. Touch the [Function Setting] on the “Maintenance” screen. The “Function Setting” screen is displayed.
Touch the [Address] on the “Function Setting” screen. The “Address” screen is displayed.
2. Touch [▲] or [▼] to select the address of the indoor units to be configured. (To set all indoor units at the same time, touch [All].)
Touch [OK] to return to the Function Setting screen.
3. Touch the [Function No.] on the “Function Setting” screen. The “Function No.” screen is displayed.

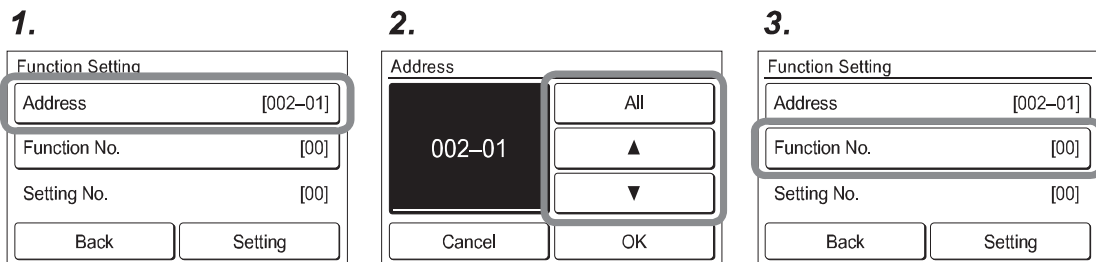

4. Touch [▲] or [▼] to set the function number. Touch [OK] to return to the “Function Setting” screen.
5. Touch the [Setting No.] on the “Function Setting” screen. The “Setting No.” screen is displayed.
6. Touch [▲] or [▼] to set the setting number. Touch [OK] to return to the “Function Setting” screen.

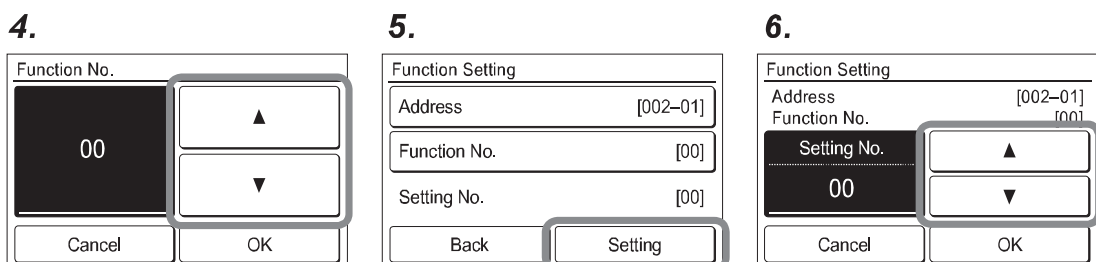

7. Touch [Back] to return to the “Maintenance” screen.

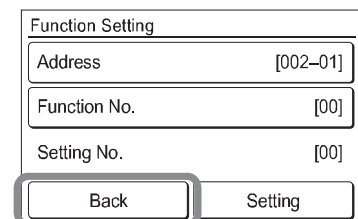

Selecting the Remote Controller Signal Code

- (1) Press the START/STOP(⏻/⏻) button until only the clock is displayed on the remote controller display.
- (2) Press the MODE button for at least 5 seconds to display the current signal code. (initially set to **A**).
- (3) Press the SET TEMP.(^)(v) buttons to change the signal code between **A**→**b**→**c**→**d**.
Match the code on the display to the air conditioner signal code.
- (4) Press the MODE button again to return to the clock display.
The signal code will be changed.

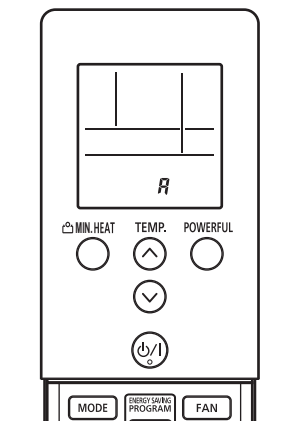

CAUTION

- If no buttons are pressed within 30 seconds after the signal code is displayed, the system returns to the original clock display.
- In this case, start again from step 1.
The air conditioner signal code is set to A prior to shipment.

3-2. THERMISTOR RESISTANCE VALUES

3-2-1 INDOOR UNIT

Room temperature thermistor		
Temp°F(°C)	Resistance(k Ω)	Voltage(V)
14 (-10)	58.25	0.73
23 (-5)	44.03	0.93
32 (0)	33.62	1.15
41 (5)	25.92	1.39
50 (10)	20.17	1.66
59 (15)	15.84	1.94
68 (20)	12.54	2.22
77 (25)	10.00	2.50
86 (30)	8.04	2.77
95 (35)	6.51	3.03
104 (40)	5.30	3.27
113 (45)	4.35	3.49

Heat exchanger thermistor		
Temp°F(°C)	Resistance(k Ω)	Voltage(V)
-22 (-30)	1131.91	0.21
-12 (-25)	804.52	0.29
-4 (-20)	579.59	0.40
5 (-15)	422.89	0.53
5 (-10)	312.27	0.69
14 (-5)	233.21	0.88
32 (0)	176.03	1.10
41 (5)	134.23	1.36
50 (10)	103.34	1.63
59 (15)	80.28	1.92
68 (20)	60.91	2.21
77 (25)	49.70	2.51
86 (30)	39.57	2.79
95 (35)	31.74	3.06
104 (40)	25.64	3.30
113 (45)	20.85	3.53
122 (50)	17.06	3.73
131 (55)	14.05	3.90
140 (60)	11.64	4.05
149 (65)	9.69	4.19
158 (70)	8.12	4.30

3-2-2 OUTDOOR UNIT

Discharge / Comp temp. thermistor		
Temp°F(°C)	Resistance(k Ω)	Voltage(V)
-4 (-20)	536.56	0.12
5 (-15)	392.31	0.16
14 (-10)	292.91	0.21
23 (-5)	221.09	0.28
32 (0)	168.60	0.36
41 (5)	129.84	0.46
50 (10)	100.91	0.57
59 (15)	79.12	0.71
68 (20)	62.55	0.86
77 (25)	49.84	1.03
86 (30)	40.01	1.23
95 (35)	32.35	1.43
104 (40)	26.34	1.65
113 (45)	21.58	1.88
122 (50)	17.79	2.11
131 (55)	14.75	2.34
140 (60)	12.30	2.57
149 (65)	10.32	2.79
158 (70)	8.70	2.30
167 (75)	7.36	3.19
176 (80)	6.27	3.37
185 (85)	5.36	3.54
194 (90)	4.60	3.69
203 (95)	3.96	3.83
212 (100)	3.43	3.96
221 (105)	2.98	4.07
230 (110)	2.60	4.17
239 (115)	2.27	4.26
248 (120)	2.00	4.33

Heat exchanger thermistor		
Temp°F(°C)	Resistance(k Ω)	Voltage(V)
-22 (-30)	95.58	0.24
-12 (-25)	68.90	0.32
-4 (-20)	50.31	0.43
5 (-15)	37.19	0.57
14 (-10)	27.81	0.73
14 (-5)	21.02	0.92
32 (0)	16.05	1.14
41 (5)	12.38	1.39
50 (10)	9.63	1.65
59 (15)	7.56	1.93
68 (20)	5.98	2.21
77 (25)	4.77	2.49
86 (30)	3.84	2.77
95 (35)	3.11	3.02
104 (40)	2.53	3.26
113 (45)	2.08	3.48
122 (50)	1.71	3.68
131 (55)	1.42	3.85
140 (60)	1.19	4.00
149 (65)	1.00	4.13
158 (70)	0.84	4.25
167 (75)	0.71	4.35
176 (80)	0.61	4.43
185 (85)	0.52	4.51
194 (90)	0.45	4.57

Outdoor temp. thermistor		
Temp°F(°C)	Resistance(k Ω)	Voltage(V)
-22 (-30)	224.33	0.73
-12 (-25)	159.71	0.97
-4 (-20)	115.24	1.25
5 (-15)	84.21	1.56
5 (-10)	62.28	1.90
14 (-5)	46.58	2.26
32 (0)	35.21	2.61
41 (5)	26.88	2.94
50 (10)	20.72	3.25
59 (15)	16.12	3.52
68 (20)	12.64	3.76
77 (25)	10.00	3.97
86 (30)	7.97	4.14
95 (35)	6.40	4.28
104 (40)	5.18	4.41
113 (45)	4.21	4.51
122 (50)	3.45	4.59
131 (55)	2.85	4.65
140 (60)	2.36	4.71
149 (65)	1.97	4.76
158 (70)	1.65	4.79
167 (75)	1.39	4.83
176 (80)	1.18	4.85

3-3. EXTERNAL INPUT AND OUTPUT

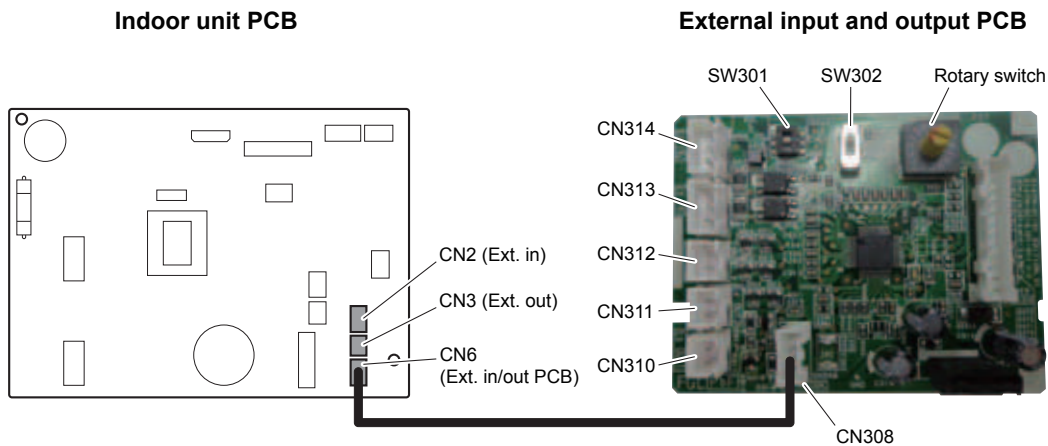

PCB	External input	External output	Connector	Input select	Input signal	External connect kit (Optional parts)
Indoor unit	Operation/Stop	-	CN2	Dry contact	Edge	-
	Forced stop					
	-	Operation status	CN3	-	-	UTY-XWZXZ3
		Error status				
Indoor unit fan operation status						
Set point attainment status						
External input and output (UTY-XCSXZ1)	Operation/Stop	-	CN313/ CN314	Dry contact/ Apply voltage	Edge/Pulse	-
	Forced stop					
	Forced thermostat off		CN313	Edge		
	-	Operation status	CN310	-	-	-
Error status		CN311				
Indoor unit fan operation status		CN312				

3-3-1. External input

- "Operation/Stop" mode or "Forced stop" mode can be selected with function setting of indoor unit.
- A twisted pair cable (22AWG) should be used. Maximum length of cable is 492ft (150 m).
- Use an external input and output cable with appropriate external dimension, depending on the number of cables to be installed.
- The wire connection should be separate from the power cable line.

Indoor unit

Indoor unit functions such as Operation/Stop can be done by using indoor unit terminals.

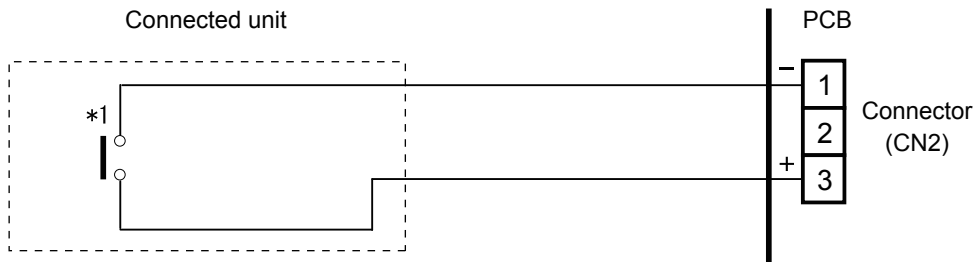

*1: The switch can be used on the following condition: DC 12 V to 24 V, 1 mA to 15 mA.

External input and output PCB

The indoor unit Operation/Stop can be set by using the input terminal on the PCB.

Input select

Use either one of these types of connectors according to the application.
(Both types of connectors cannot be used simultaneously.)

- Dry contact

In case of internal power supply, set the slide switch of SW301 to "NON VOL" side.

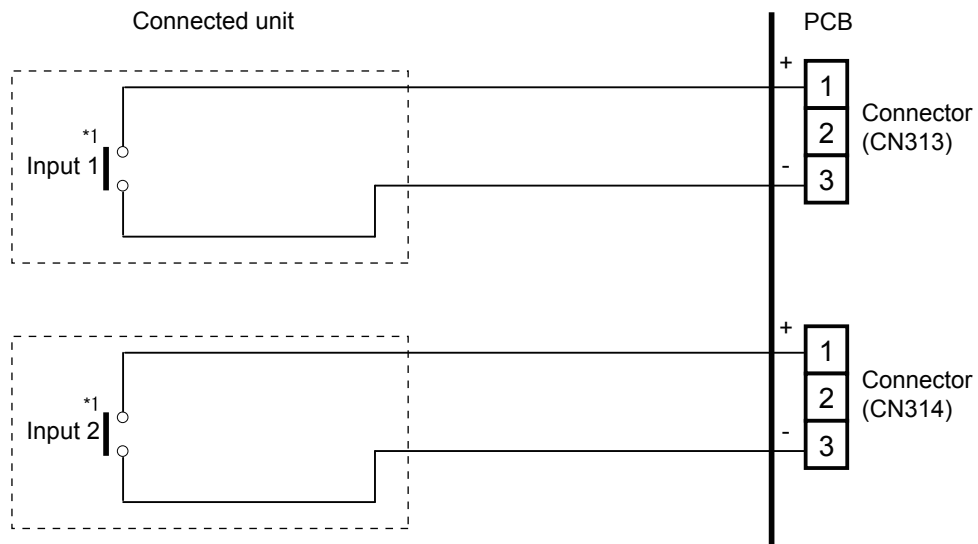

*1: The switches can be used on the following condition: DC 12 V to 24 V, 1 mA to 15 mA.

- Apply voltage

In case of external power supply, set the slide switch of SW301 to "VOL" side.

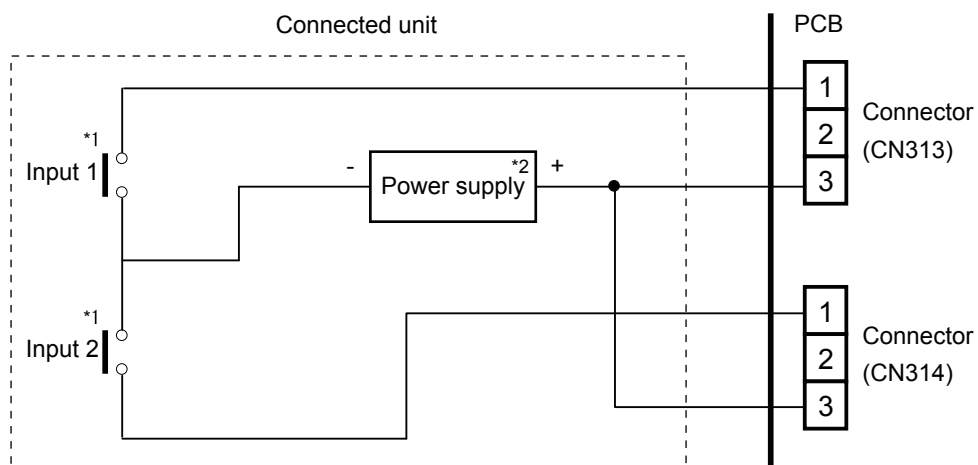

*1: The switches can be used on the following condition: DC 12 V to 24 V, 1 mA to 15 mA.

*2: Make the power supply DC 12 to 24 10 mA or more.

3-3-2. External output

Use an external output cable with appropriate external dimension, depending on the number of cables to be installed.

■ Indoor unit

- A twisted pair cable (22AWG) should be used. Maximum length of cable is 82ft (25 m).
- Output voltage: High DC 12 V \pm 2 V, Low 0 V.
- Permissible current: 50 mA
- For details, refer to Chapter 10-3. "Combination of external input and output" on page 31.

● When indicator, etc. are connected directly

Example: Function setting 60 is set to "00"

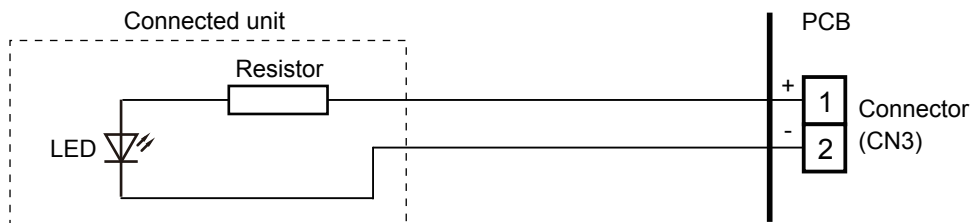

● When connecting with a device equipped with a power supply

Example: Function setting 60 is set to "00"

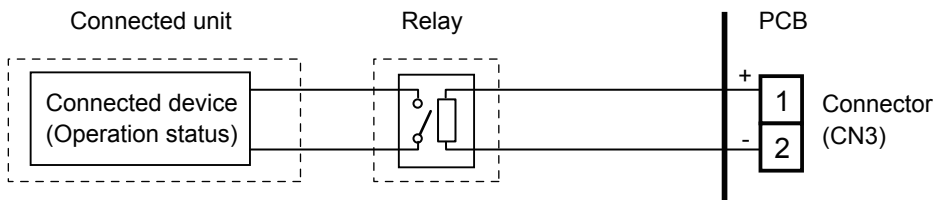

External input and output PCB

- A twisted pair cable (22AWG) should be used. Maximum length of cable is 82 ft (25 m).
- Output voltage: High DC 12 V \pm 2 V, Low 0 V.
- Permissible current: 50 mA
- For details, refer to Chapter 10. "[Combination of external input and output](#)" on page 29.

When indicator or other components are connected directly

Example: Function setting 60 is set to "00".

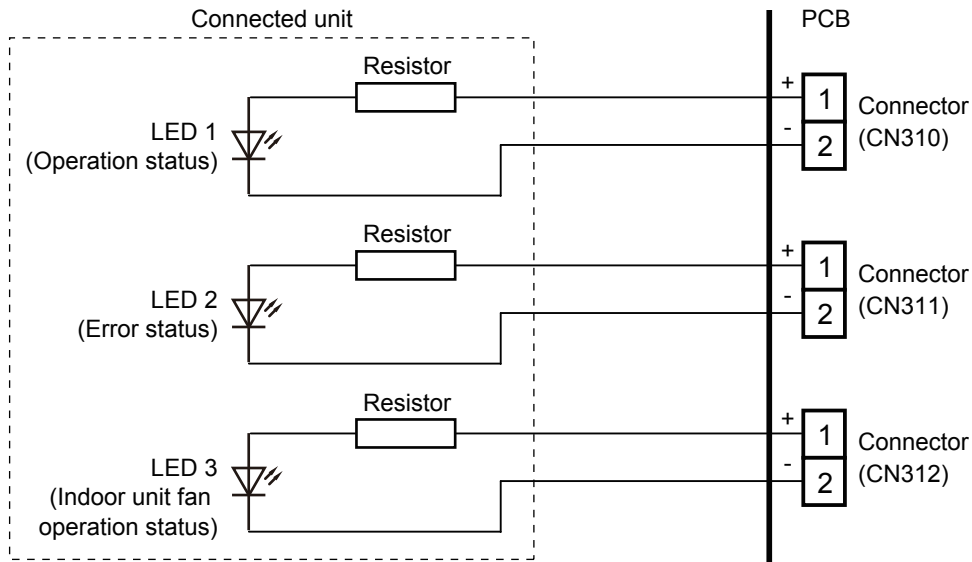

When connecting with a device equipped with a power supply

Example: Function setting 60 is set to "00".

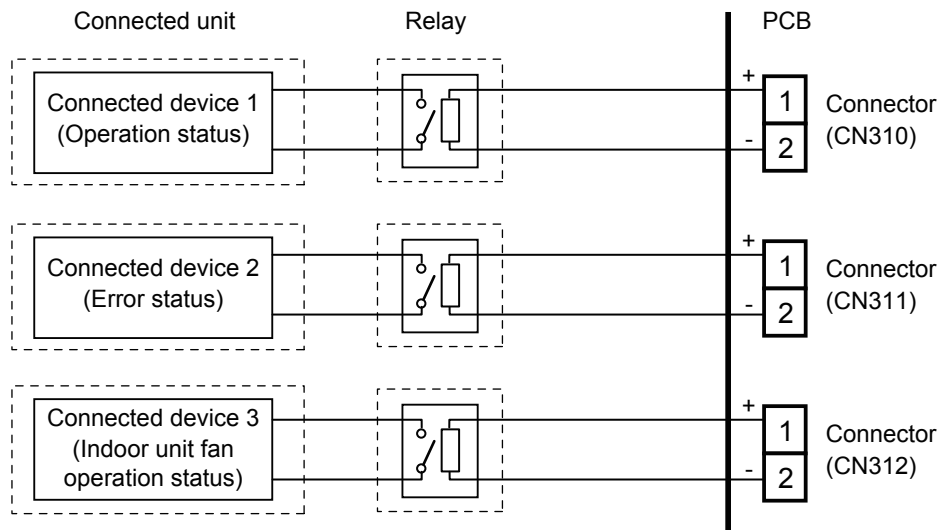

3-3-3. Combination of external input and output

By combining the function setting of the indoor unit and rotary switch setting of the External input and output PCB, you can select various combinations of functions.

Combination examples of external input and output are as follows:

Mode	Function setting	Rotary SW	External input		
			Indoor unit	External input and output PCB	
			CN2	1 CN313	2 CN314
0-1	60—00	1	Operation/Stop (Function setting 46-00) or Emergency stop (Function setting 46-01) or Forced stop (Function setting 46-02)	Operation/Stop	Not available
				Operation	Stop
0-2	60-00	2		Forced thermostat Off	Not available
1	60-01	3		Mechanical cooling Off	
2	60-02	4		Forced thermostat Off	
3	60-03	5		Mechanical cooling On	
4	60-04	6		Mechanical cooling On	
5	60-05	7		Forced thermostat Off	
6	60-06	8		Forced thermostat Off	
7	60-07	9		Mechanical cooling Off	
8	60-08	A		Forced thermostat Off	
9	60-09	B		Forced thermostat Off	
10	60-10	C	Forced thermostat Off		
11	60-11	D	Forced thermostat Off		
12	60-12	D	Forced thermostat Off		

Mode	Function setting	Rotary SW	External output			
			Indoor unit	External input and output PCB		
			CN3	1 CN310	2 CN311	3 CN312
0-1	60-00	1	Operation/Stop	Operation/Stop	Error status	Indoor unit fan operation status
0-2	60-00	2	Operation/Stop	Error status	Indoor unit fan operation status	External heater output
1	60-01	3	Cooling thermostat On	Error status	Indoor unit fan operation status	External heater output
2	60-02	4	Cooling thermostat On	Error status	Remote controller output	External heater output
3	60-03	5	Cooling thermostat On	Cooling high/low output	Remote controller output	External heater output
4	60-04	6	Cooling thermostat On	Error status	Remote controller output	Cooling high/low output
5	60-05	7	Heating thermostat On	Error status	Indoor unit fan operation status	External heater output
6	60-06	8	Operation/Stop	Error status	Indoor unit fan operation status	Heating thermostat On
7	60-07	9	Cooling thermostat On	Error status	Heating thermostat On	External heater output

Mode	Function setting	Rotary SW	External output			
			Indoor unit	External input and output PCB		
			CN3	1 CN310	2 CN311	3 CN312
8	60-08	A	Cooling thermostat On	Heating thermostat On	Remote controller output	External heater output
9	60-09	B	Error status	Operation/Stop	Indoor unit fan operation status	External heater output
10	60-10	C	Indoor unit fan operation status	Operation/Stop	Error status	External heater output
11	60-11	D	External heater output	Operation/Stop	Indoor unit fan operation status	Error status
12	60-12	D	Set point attainment status	Operation/Stop	Indoor unit fan operation status	Error status

NOTE: Input of Operation/Stop depends on the setting of function setting 46.

00: Operation/Stop mode 1 (R.C. enabled)

01: (Setting prohibited)

02: Forced stop

03: Operation/Stop mode 2 (R.C. disabled)

■ Input signal type

- **Indoor unit**

Input signal type is only "Edge".

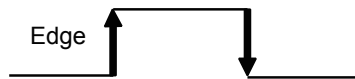

- **External input and output PCB**

The input signal type can be selected.

Signal type (edge or pulse) can be switched by the DIP switch SW302 on the External input and output PCB.

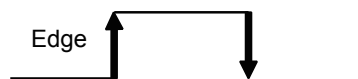

The width of pulse must be longer than 200 msec.

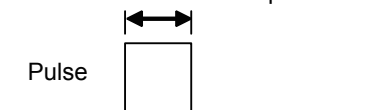

■ Control input function

● When function setting is "Operation/Stop" mode 1

- In the case of "Edge" input

Mode	Function setting /	Rotary SW on External input and output PCB	External input		Input signal	Command
0-1	46-00	-	Input of indoor unit	CN2	Off → On	Operation
					On → Off	Stop
		60-00 / 1	External input and output PCB	CN313	Off → On	Operation
					On → Off	Stop

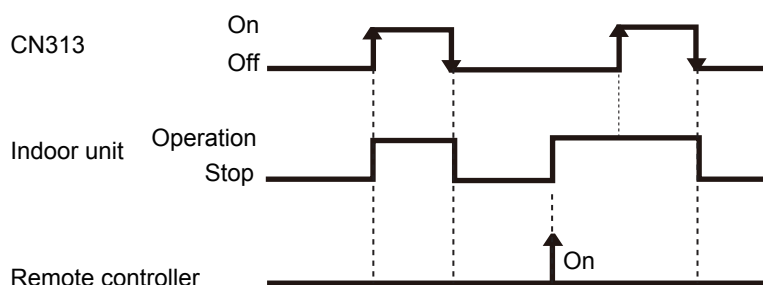

- In the case of "Pulse" input

Mode	Function setting /	Rotary SW on External input and output PCB	External input		Input signal	Command
0-1	46-00	60-00 / 1	External input and output PCB	CN313	Pulse	Operation
				CN314	Pulse	Stop

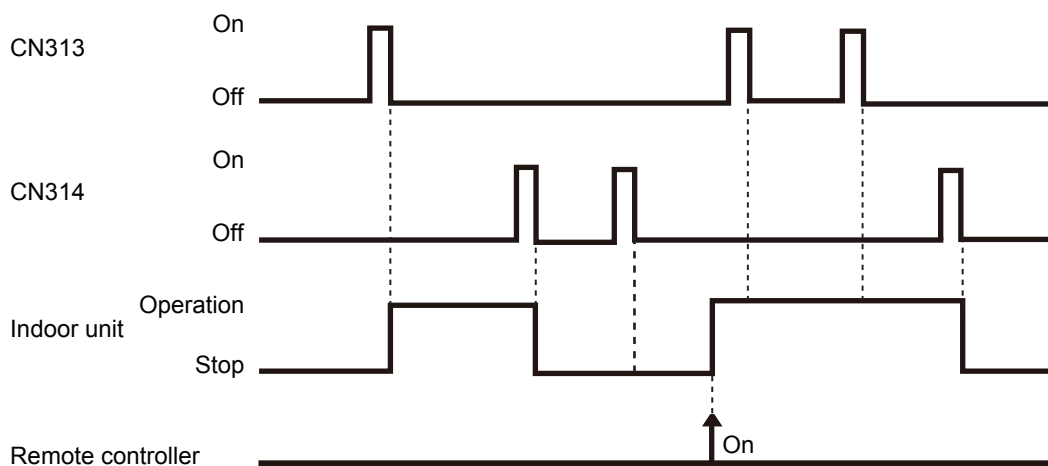

NOTES:

- The last command has priority.
- The indoor units within the same remote controller group operates in the same mode.
- This function is invalid when function setting 96 is set to "02" (Secondary unit).

● When function setting is "Forced stop" mode

- In the case of "Edge" input

Mode	Function setting /	Rotary SW on External input and output PCB	External input		Input signal	Command
0-1	46-02	-	Input of indoor unit	CN2	Off → On	Forced stop
					On → Off	Normal
		60-00 / 1	External input and output PCB	CN313	Off → On	Forced stop
					On → Off	Normal

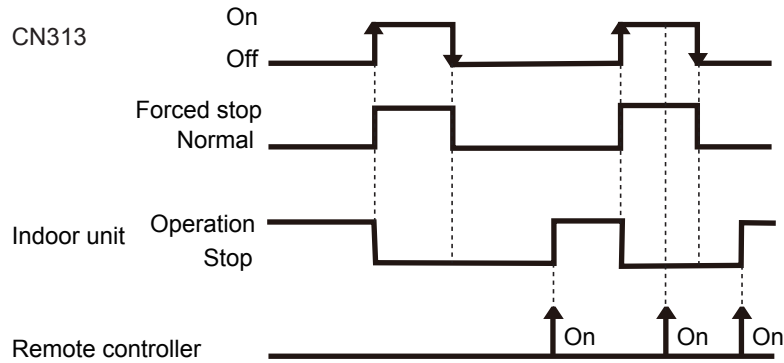

- In the case of "Pulse" input

Mode	Function setting /	Rotary SW on External input and output PCB	External input		Input signal	Command
0-1	46-02	60-00 / 1	External input and output PCB	CN313	Pulse	Forced stop
				CN314	Pulse	Normal

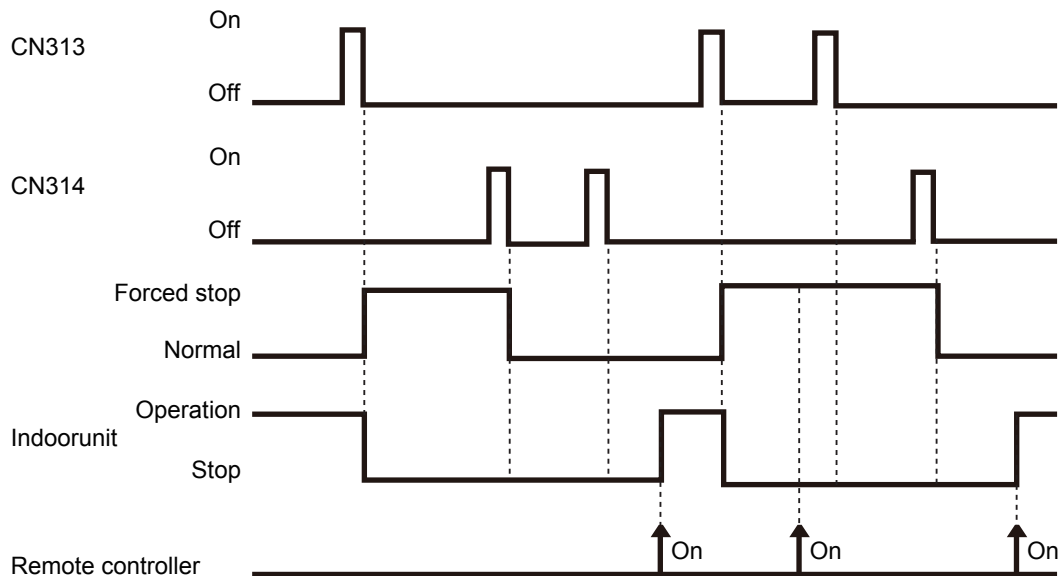

NOTES:

- When the forced stop is triggered, indoor unit stops and Operation/Stop operation by the remote controller is restricted.
- When forced stop function is used with forming a remote controller group, connect the same equipment to each indoor unit within the group.
- This function is invalid when function setting 96 is set to "02" (Secondary unit).

● When function setting is "Operation/Stop" mode 2

- In the case of "Edge" input

Mode	Function setting /	Rotary SW on External input and output PCB	External input		Input signal	Command
0-1	46-03	-	Input of indoor unit	CN2	Off → On	Operation
					On → Off	Stop (R.C. disabled)
		60-00 / 1	External input and output PCB	CN313	Off → On	Operation
					On → Off	Stop (R.C. disabled)

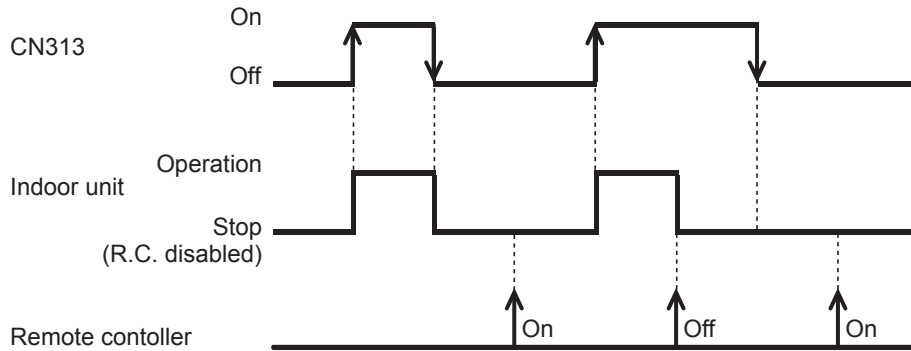

- In the case of "Pulse" input

Mode	Function setting /	Rotary SW on External input and output PCB	External input		Input signal	Command
0-1	46-03	60-00 / 1	External input and output PCB	CN313	Pulse	Operation
				CN314	Pulse	Stop (R.C. disabled)

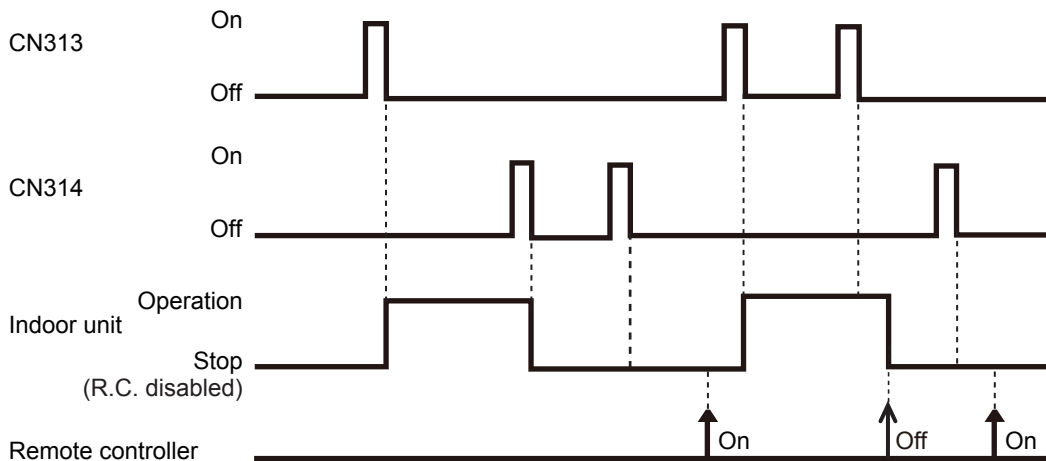

NOTES:

- When "Operation/Stop" mode 2 function is used with forming a remote controller group, connect the same equipment to each indoor unit within the group.
- This function is invalid when function setting 96 is set to "02" (Secondary unit).

● Forced thermostat off function

Mode	Function setting / Rotary SW on External input and output PCB	External input		Input signal	Command
0-1 9 10	60-00 / 2 60-09 / B 60-10 / C	External input and output PCB	CN313	Off → On	Thermostat off
				On → Off	Normal operation

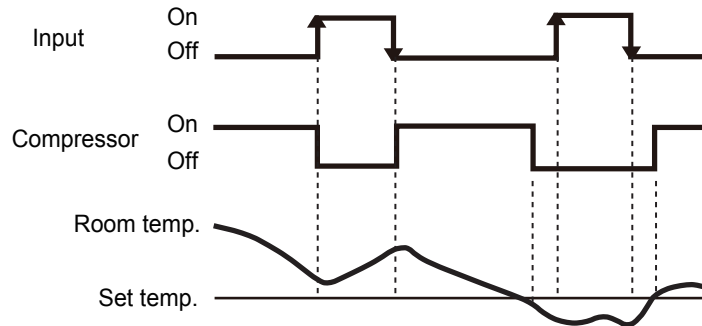

• Example of individual connection

Forced thermostat off is one of the function to save energy. For example, case of using ventilator at condition with outdoor temperature is lower than indoor temperature, indoor unit of air conditioner stop based upon receiving signal from external controller. (Cooling only)

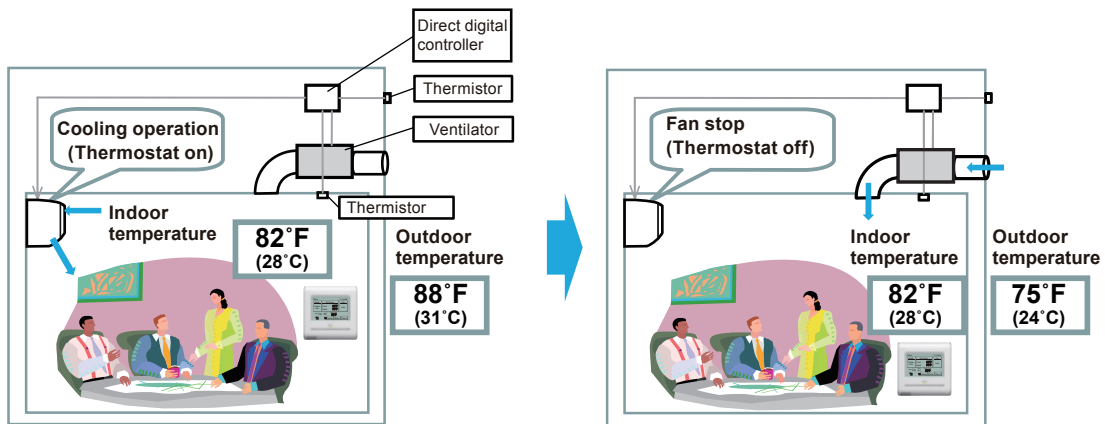

• System figure example

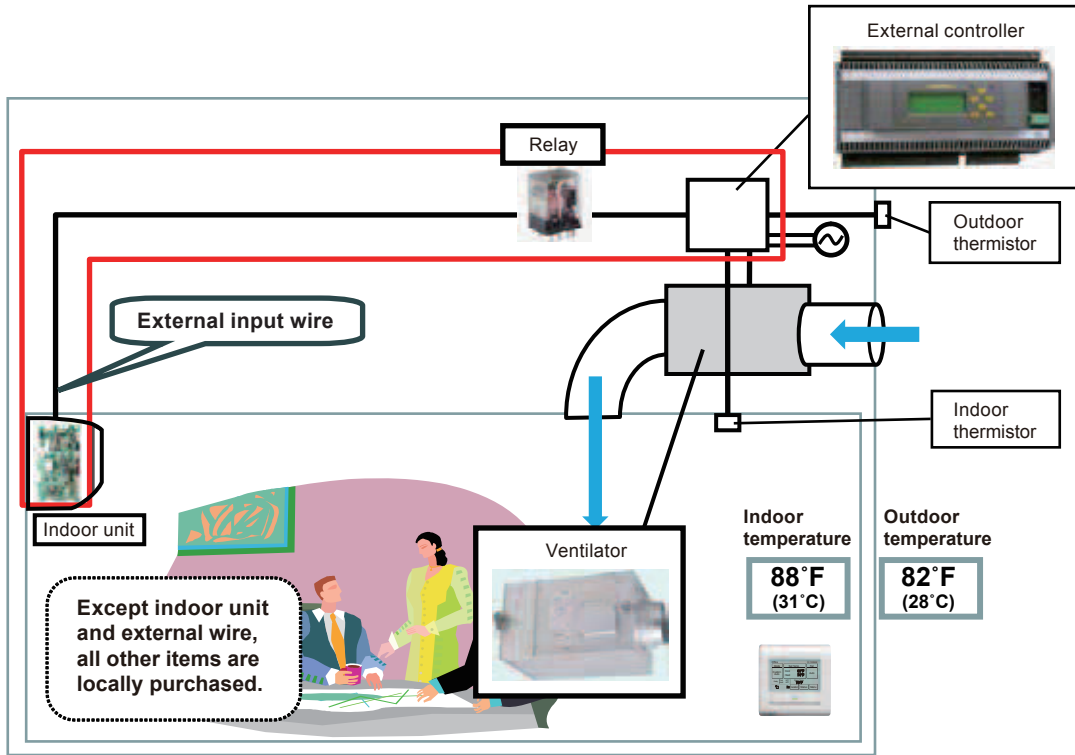

• Operation status

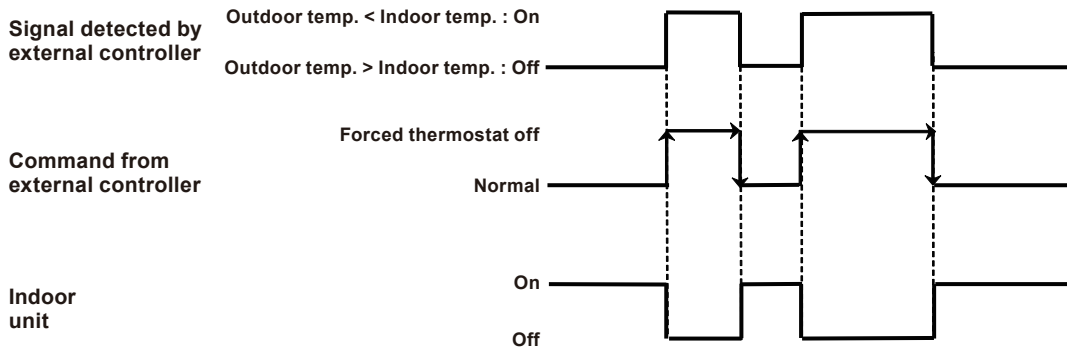

Normal means that indoor unit continues to operate until “Forced thermostat Off” signal received, at condition which are set by central and individual controller or detected by thermo sensors of indoor unit.

Indoor unit continues to operate until “Forced thermostat Off” signal received, at condition which are set by central and individual controller or detected by thermo sensors of indoor unit. Once “Forced thermostat Off” signal received, indoor unit stop operation.

■ Control output function

● Operation/Stop status

Mode	Function setting / Rotary SW on External input and output PCB	External output		Output signal	Command
0-1 0-2	60-00 / 1, 2	Output of indoor unit	CN3	Low → High	Operation
				High → Low	Stop
0-1	60-00 / 1	External input and output PCB	CN310	Off → On	Operation
				On → Off	Stop

The output is low when the unit is stopped.

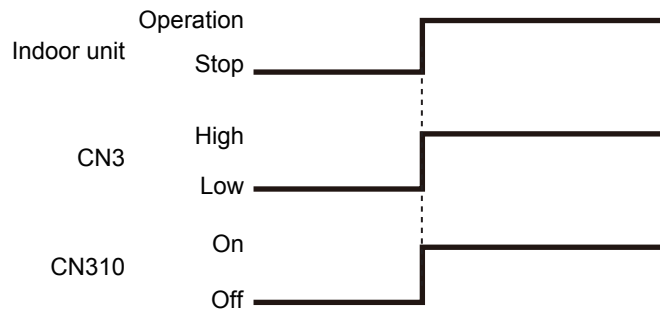

● Error status

Mode	Function setting / Rotary SW on External input and output PCB	External output		Output signal	Command
9	60-09 / B	Output of indoor unit	CN3	Low → High	Error
				High → Low	Normal
0-1	60-00 / 1	External input and output PCB	CN311	Off → On	Error
				On → Off	Normal

The output is ON when an error is generated for the indoor unit.

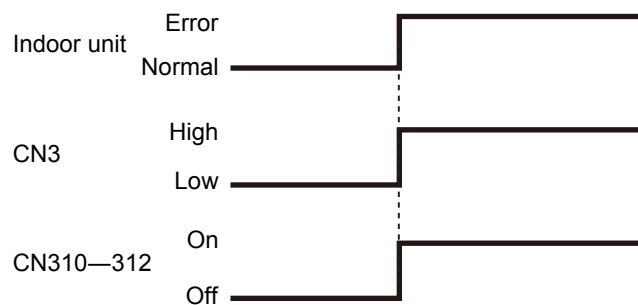

● Indoor unit fan operation status

Mode	Function setting /	Rotary SW on External input and output PCB	External output		Output signal	Command
10		60-10 / C	Output of indoor unit	CN3	Low → High	Fan run
					High → Low	Fan stop
0-1		60-00 / 1	External input and output PCB	CN312	Off → On	Fan run
					On → Off	Fan stop

Output signal	Condition
On Low → High	The indoor unit fan is operating.
Off High → Low	The fan is stopped or during cold air prevention. During thermostat off when in dry mode operation.

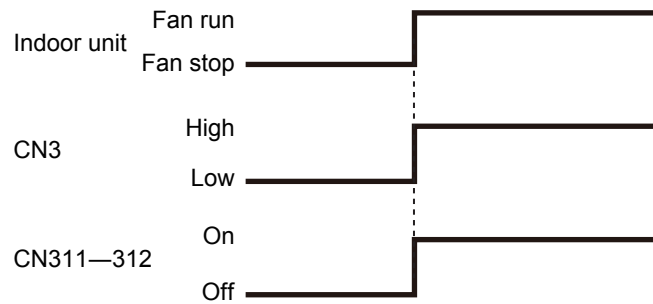

● Set point attainment status

NOTE: This function is valid only when function setting 96 is set to “01” (Primary unit) or “02” (Secondary unit).

When the room temperature does not reach the set point at a room due to the lower cooling performance caused by external factor such as the outdoor temperature change, signal is output to tell the attainment status of set point.

Mode	Function setting / Rotary SW on External input and output PCB	External output		Output signal	Command
12	60-12 / D	Output of indoor unit	CN3	On → Off	Normal
				Off → On	Set point attainment

Output signal	Condition
Off	Reached the set point. ($T_r \leq T_{s\alpha} + 1^\circ\text{F}$ [0.5°C])
On	Unreached the set point. ($T_r > T_{s\alpha} + 5^\circ\text{F}$ [2.5°C]) However, even if the set point unreached, the signal will not be output for 7 minutes after power is turned on.

When performing the server room control, both of the primary unit and secondary unit output the set point attainment status if any of the unit is outputting alternative operation command.

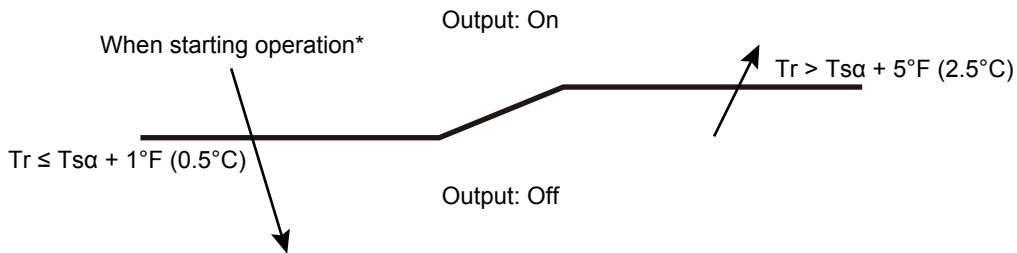

*: When starting operation or resetting, judges the zone to descending direction.

■ Fresh air conditioner (for external control module*) input function (mode 1 or 7)

* Module that reduces or stops the cooling operating ratio of the air conditioner by intaking fresh air such as Direct digital controller.

Mode	Function setting	External input	External output	Input signal*	Command
1 7	60-01 60-07	CNA03 or CNA04 (EXT. IN2) Mechanical cooling Off	CNB01 (Pin: 1-2) Cooling thermostat On	Off → On	Mechanical cooling Off
				On → Off	Normal operation

* Edge input only.

- With using “Fresh air conditioner” input and “Cooling thermostat On” output, external control module controls the cooling operation by the air conditioner.
- When “Fresh air conditioner On” is input during cooling thermostat on, fresh air conditioning is performed with stopping the cooling operation by the air conditioner.

NOTE: During operations other than cooling such as heating or dry, “Fresh air conditioner On” input is disabled.

• Example of individual connection

Output: Cooling thermostat On

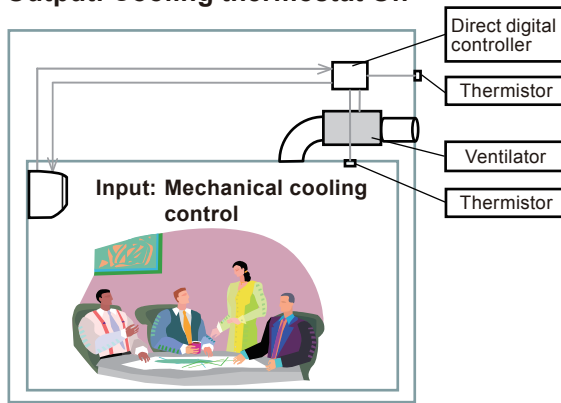

① Output: Off (Cooling thermostat Off)

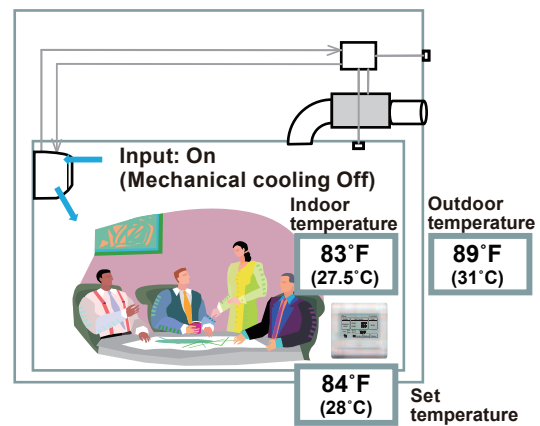

② Output: On (Cooling thermostat On)

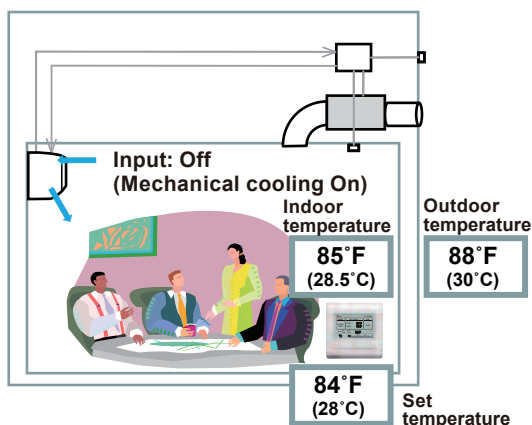

③ Output: On (Cooling thermostat On)

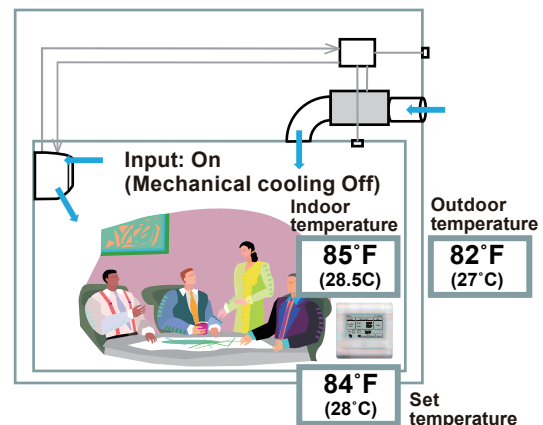

• Operation status

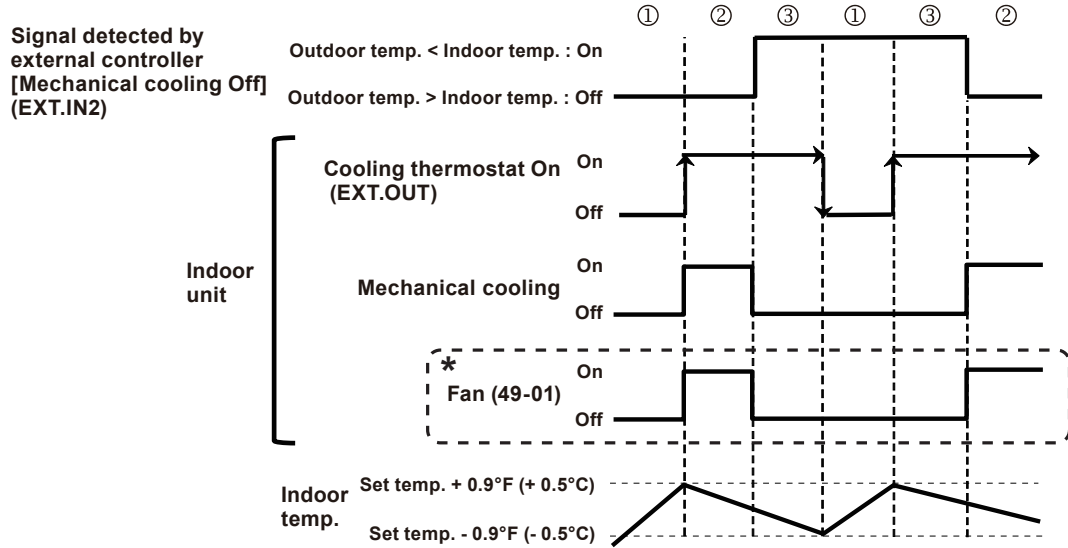

*: This status follows the configuration on function setting 49.

- 0: Setting airflow (When comp. on)
- 1: Intermittent S-Lo (On: 1 minute and off: 3 minutes)
- 2: Remote controller setting (Either of 0 or 1)

External heater output

Control	Primary heater	Auxiliary heater	Function setting	
			Indoor unit	Wired R. C.
			Control switching external heaters No. 61	Sensor activation (UTY-RNRUZ1)
Auxiliary heater control 1	RAC heat pump	External device (Hot water electrical heater, etc.)	61-00	—
Auxiliary heater control 2	RAC heat pump	External device (Hot water electrical heater, etc.)	61-01	—
Heat pump prohibition control	External device (Hot water electrical heater, etc.)	None	61-02	On (Enabled)*
Heater selection control by outdoor temperature 1	RAC heat pump	External device (Hot water electrical heater, etc.)	61-03	On (Enabled)*
Heater selection control by outdoor temperature 2	External device (Hot water electrical heater, etc.)	RAC heat pump	61-04	On (Enabled)*

NOTES:

- After turning off the heater, 3 minutes of standby time is required by next power-on of the heater.
- For items marked “—” in the table, any of validate or invalidate of the setting are acceptable.
- *: setting change from the factory setting is required.
- *: Indoor unit fan setting will be on for safety reason without sensor activation of wired remote controller.

Installation configuration of individual connection

External heating device is installed individually. (No use of indoor unit fan)

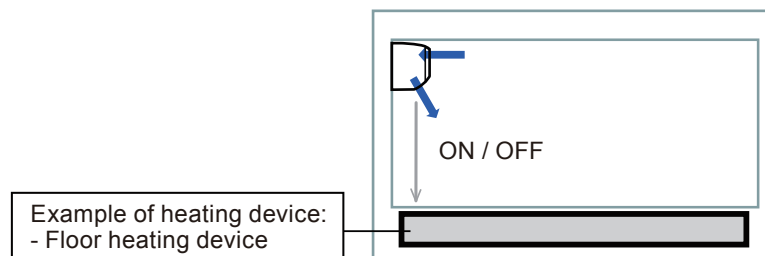

⚠ WARNING

- When auxiliary heater is installed, always set “indoor unit fan setting for external heater”.
- Design and install external heater appropriately with considering its protection.

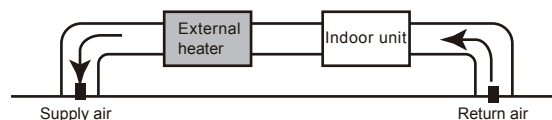

- Inappropriate designing and installation of external heater may cause a fire by emitted heat from the external heater.
- Fujitsu General Ltd. is not responsible for inappropriate designing or installation of external heating device.

● Auxiliary heater control 1

Operation	Condition
Heater on	Heater is on as shown in following diagram of heating temperature.
Heater off	<ul style="list-style-type: none"> • Heater is off as shown in following diagram of heating temperature. • Other than heating mode • Error occurred • Forced thermostat off • Fan stop protection

- Temperature of heater on (Thon): Adjustable by function setting no. 62 (Operating temperature switching of external heaters).
- All control temperatures will shift by adjusting “Thon”.

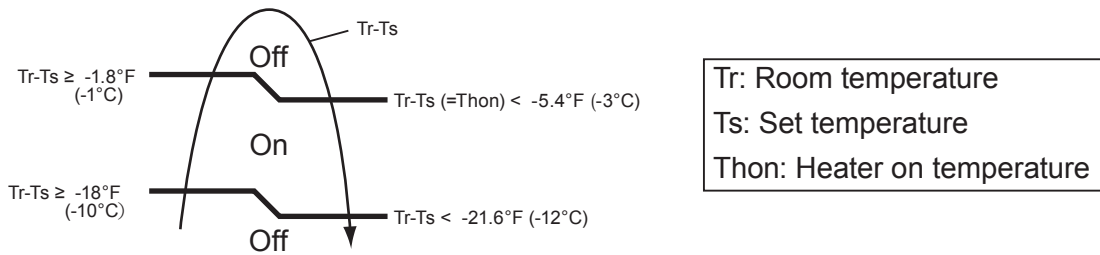

Example: When set temperature (Ts) is 72°F (22°C) (Factory setting),

- and room temperature (Tr) increases above 53.6°F (12°C), signal output is on.
- and room temperature (Tr) increases above 69.8°F (21°C), signal output is off.
- and room temperature (Tr) decreases below 66.2°F (19°C), signal output is on.
- and room temperature (Tr) decreases below 50°F (10°C), signal output is off.

● Auxiliary heater control 2

Operation	Condition
Heater on	Heater is on as shown in following diagram of heating temperature.
Heater off	<ul style="list-style-type: none"> • Heater is off as shown in following diagram of heating temperature. • Other than heating mode • Error occurred • Forced thermostat off • Fan stop protection

- Temperature of heater on (Thon): Adjustable by function setting no. 62 (Operating temperature switching of external heaters).
- All control temperatures will shift by adjusting “Thon”.

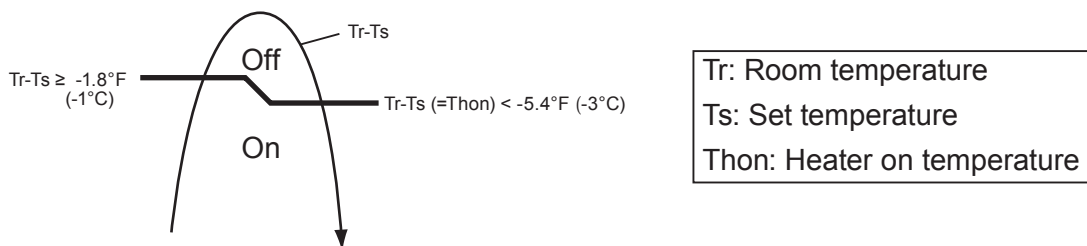

● Heat pump prohibition control

Operation	Condition
Heater on	Heater is on as shown in following diagram of heating temperature.
Heater off	<ul style="list-style-type: none"> • Heater is off as shown in following diagram of heating temperature. • Other than heating mode • Error occurred • Forced thermostat off

- Temperature of heater on (Thon): Adjustable by function setting no. 62 (Operating temperature switching of external heaters).
- All control temperatures will shift by adjusting "Thon".

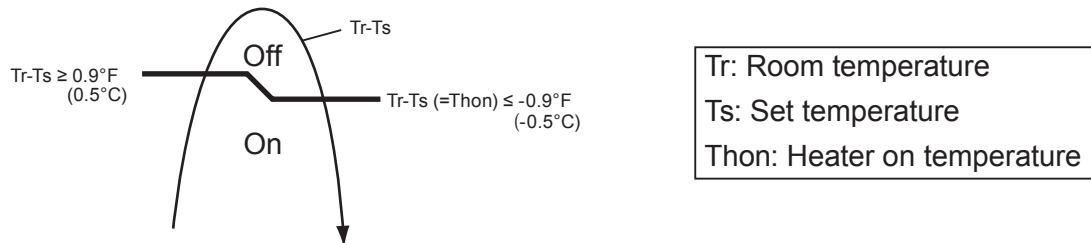

Operation status

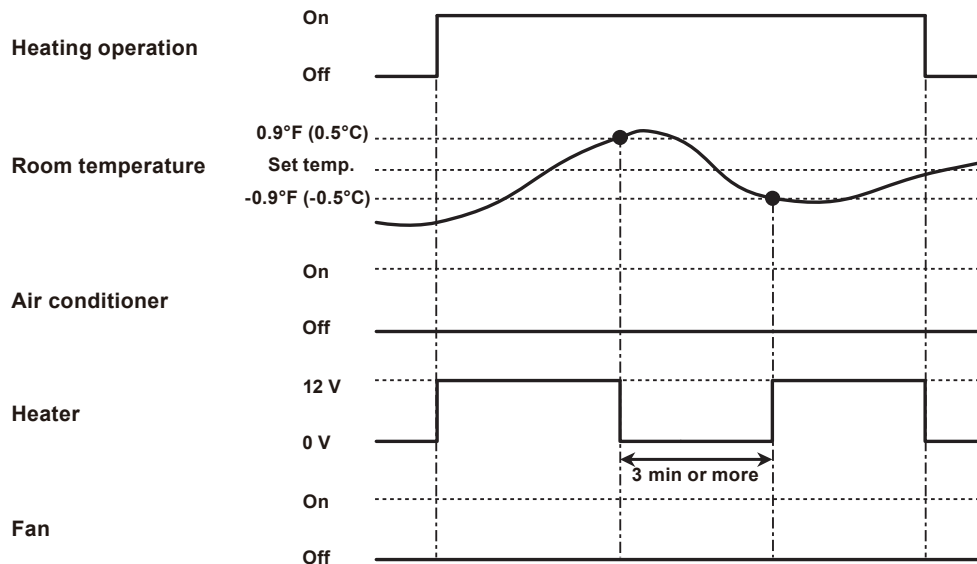

NOTE: In following operations, compressor will be on.

- Other than heating
- Test run

● Heater selection control by outdoor temperature 1

Operation	Condition
Heater on	Heater is on as shown in following diagram of heating temperature.
Heater off	<ul style="list-style-type: none"> • Heater is off as shown in following diagram of heating temperature. • Other than heating mode • Error occurred • Forced thermostat off • Heat pump only zone

- Temperature of heater on (Thon): Adjustable by function setting no. 62 (Operating temperature switching of external heaters).
- All control temperatures will shift by adjusting “Thon”.
- Outdoor temperature zone boundary A and B: Adjustable individually by function setting no. 36 and 37 for outdoor unit.

• External heater output

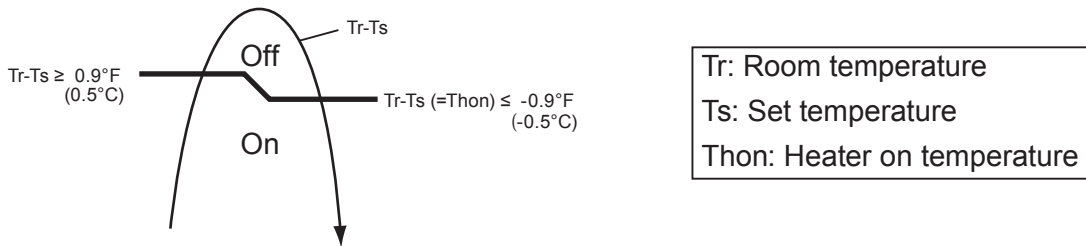

• Outdoor temperature zone

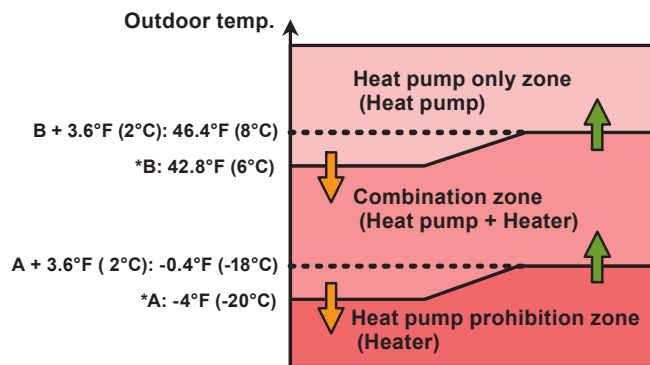

*Adjustable by function setting no. 66 and 67

• Operation status

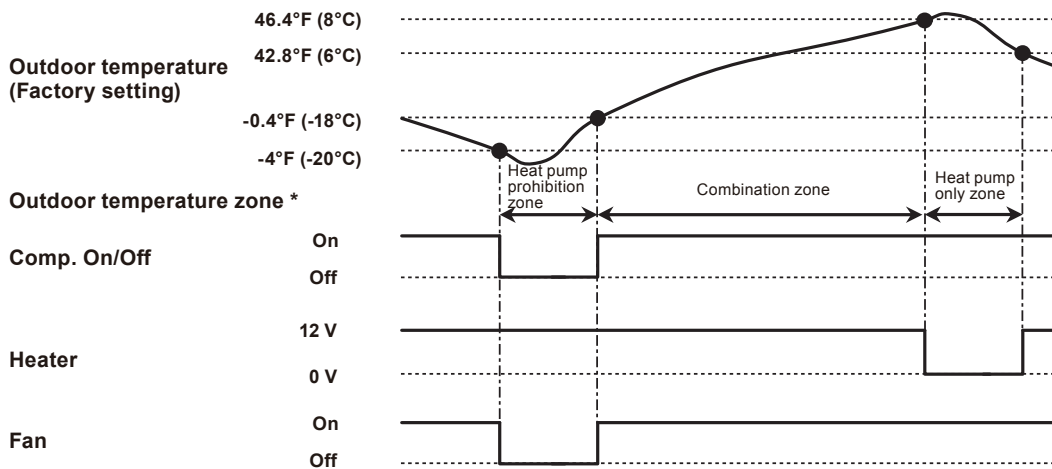

* The outdoor temperature zone transition from one to another will stay in that zone for minimum of 30 min.

NOTE: In following operations, compressor will be on in heat pump prohibition zone.

- Other than heating
- Test run

● Heater selection control by outdoor temperature 2

Operation	Condition
Heater on	Heater is on as shown in following diagram of heating temperature.
Heater off	<ul style="list-style-type: none"> • Heater is off as shown in following diagram of heating temperature. • Other than heating mode • Error occurred • Forced thermostat off

- Temperature of heater on (Thon): Adjustable by function setting no. 62 (Operating temperature switching of external heaters).
- All control temperatures will shift by adjusting "Thon".
- Outdoor temperature zone boundary A and B: Adjustable by function setting no. 36 for outdoor unit.

• External heater output

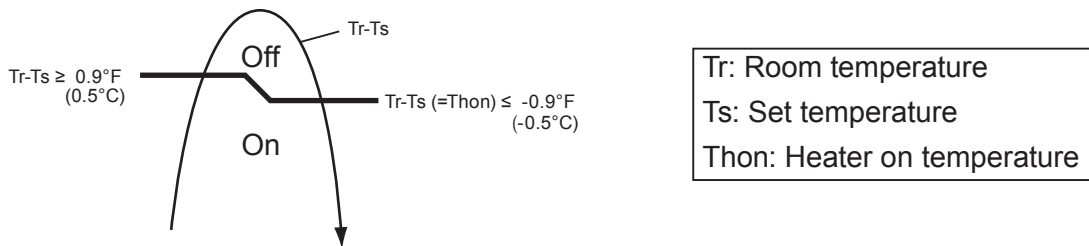

• Outdoor temperature zone

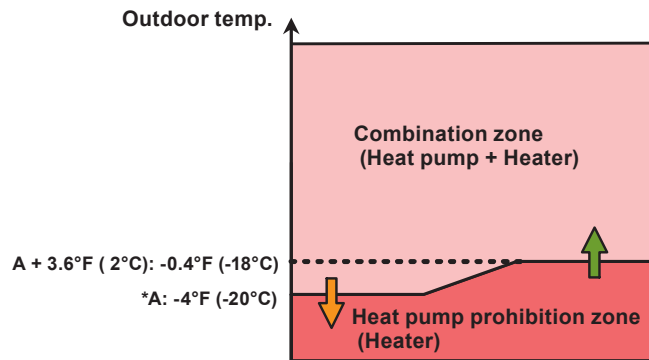

*Adjustable by function setting no. 66.

• Operation status

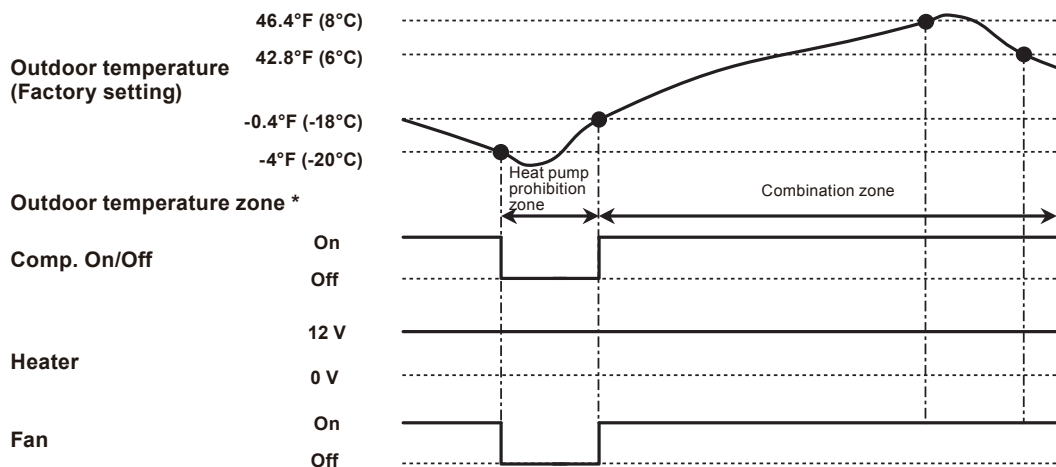

*The outdoor temperature zone transition from one to another will stay in that zone for minimum of 30 min.

NOTE: In following operations, compressor will be on in heat pump prohibition zone.

- Other than heating
- Test run

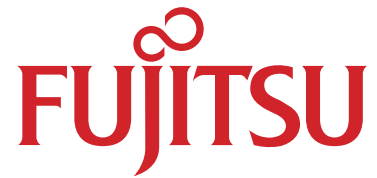

FUJITSU GENERAL LIMITED

3-3-17, Suenaga, Takatsu-ku, Kawasaki 213-8502, Japan