

AIR CONDITIONER

Duct type

DESIGN & TECHNICAL MANUAL

INDOOR



ARU12RGLX



ARU18RGLX
ARU24RGLX
ARU30RGLX



ARU36RGLX
ARU42RGLX
ARU48RGLX

OUTDOOR



AOU12RLF



AOU18RGLX
AOU24RGLX
AOU30RGLX
AOU36RGLX



AOU42RGLX
AOU48RGLX

FUJITSU GENERAL LIMITED

Notices:

- Product specifications and design are subject to change without notice for future improvement.
- For further details, please check with our authorized dealer.

CONTENTS

Part 1. INDOOR UNIT	1
1. Specifications	2
2. Dimensions	8
2-1. Model: ARU12RGLX.....	8
2-2. Models: ARU18RGLX, ARU24RGLX, and ARU30RGLX.....	9
2-3. Models: ARU36RGLX, ARU42RGLX, and ARU48RGLX.....	10
2-4. Installation space requirement.....	11
2-5. Maintenance space requirement.....	12
3. Wiring diagrams	13
3-1. Models: ARU12RGLX, ARU18RGLX, and ARU24RGLX.....	13
3-2. Models: ARU30RGLX, ARU36RGLX, ARU42RGLX, and ARU48RGLX.....	14
4. Capacity table	15
4-1. Cooling capacity.....	15
4-2. Heating capacity.....	22
5. Fan performance	26
5-1. Fan performance curve.....	26
5-2. Airflow.....	40
6. Operation noise (sound pressure)	47
6-1. Noise level curve.....	47
6-2. Sound level check point.....	50
7. Safety devices	51
8. External input and output	52
8-1. External input.....	52
8-2. External output.....	54
8-3. Combination of external input and output.....	55
8-4. Details of function.....	58
9. Function settings	83
9-1. Function settings on indoor unit.....	83
9-2. Function settings by using remote controller.....	85
10. Accessories	93
11. Optional parts	94
11-1. Controllers.....	94
11-2. Others.....	95

CONTENTS (continued)

Part 2. OUTDOOR UNIT97

1. Specifications	98
2. Dimensions	101
2-1. Model: AOU12RLFC	101
2-2. Models: AOU18RGLX, AOU24RGLX, AOU30RGLX, and AOU36RGLX.....	102
2-3. Models: AOU42RGLX and AOU48RGLX	103
3. Installation space	104
3-1. Model: AOU12RLFC	104
3-2. Models: AOU18RGLX, AOU24RGLX, AOU30RGLX, and AOU36RGLX.....	107
3-3. Models: AOU42RGLX and AOU48RGLX	110
4. Refrigerant circuit	113
4-1. Model: AOU12RLFC	113
4-2. Models: AOU18RGLX, AOU24RGLX, AOU30RGLX, and AOU36RGLX.....	114
4-3. Models: AOU42RGLX and AOU48RGLX	115
5. Wiring diagrams	116
5-1. Model: AOU12RLFC	116
5-2. Model: AOU18RGLX.....	117
5-3. Models: AOU24RGLX, AOU30RGLX, and AOU36RGLX	118
5-4. Models: AOU42RGLX and AOU48RGLX	119
6. Capacity compensation rate for pipe length and height difference.....	120
6-1. Model: AOU12RLFC	120
6-2. Models: AOU18RGLX, AOU24RGLX, AOU30RGLX, and AOU36RGLX.....	121
6-3. Models: AOU42RGLX and AOU48RGLX	122
7. Additional charge calculation	123
7-1. Model: AOU12RLFC	123
7-2. Model: AOU18RGLX.....	123
7-3. Models: AOU24RGLX, AOU30RGLX, and AOU36RGLX	123
7-4. Models: AOU42RGLX and AOU48RGLX	124
8. Airflow	125
8-1. Model: AOU12RLFC	125
8-2. Model: AOU18RGLX.....	125
8-3. Model: AOU24RGLX.....	125
8-4. Model: AOU30RGLX.....	126
8-5. Model: AOU36RGLX.....	126
8-6. Model: AOU42RGLX.....	126
8-7. Model: AOU48RGLX.....	127
9. Operation noise (sound pressure)	128
9-1. Noise level curve.....	128
9-2. Sound level check point	131
10. Electrical characteristics	132

CONTENTS (continued)

11. Safety devices	133
12. External input and output (For AOU42RGLX and AOU48RGLX).....	135
12-1.External input	135
12-2.External output.....	137
13. Function settings (For AOU42RGLX and AOU48RGLX)	139
13-1.Local setting switch buttons	139
13-2.Local setting procedure.....	141
14. Accessories	144
14-1.Model: AOU12RLFC	144
14-2.Models: AOU18RGLX, AOU24RGLX, AOU30RGLX, and AOU36RGLX.....	144
14-3.Models: AOU42RGLX and AOU48RGLX	144
15. Optional parts	145

Part 1. INDOOR UNIT

DUCT TYPE:

ARU12RGLX

ARU18RGLX

ARU24RGLX

ARU30RGLX

ARU36RGLX

ARU42RGLX

ARU48RGLX

1. Specifications

Type				Duct		
				Inverter heat pump		
Model name				ARU12RGLX		
Power supply				208/230 V ~ 60 Hz		
Power supply intake				Outdoor unit		
Available voltage range				187—253 V		
Capacity	Cooling	Rated	kW	3.52		
			Btu/h	12,000		
		Min.—Max.	kW	0.9—4.0		
			Btu/h	3,100—13,600		
	Heating	47 °FDB (Outdoor temp.)	Rated	kW	4.69	
			Btu/h	16,000		
		Min.—Max.	kW	0.9—5.7		
			Btu/h	3,100—19,400		
17 °FDB (Outdoor temp.)	Rated	kW	4.27			
	Btu/h	14,500				
	Max.	kW	5.18			
	Btu/h	17,600				
Input power	Cooling	Rated	kW	0.89		
				Min.—Max.	0.12—1.45	
		Heating	47 °FDB (Outdoor temp.)	Rated	1.20	
				Min.—Max.	0.14—1.84	
	17 °FDB (Outdoor temp.)		Rated	1.28		
			Max.	1.97		
	Fan	HIGH	W	61		
				MED	34	
				LOW	24	
				QUIET	16	
	Current	Cooling	Rated	A	3.9	
					Heating	5.3
EER	Cooling			kW/kW	3.93	
				Btu/hW	13.4	
COP	Heating			kW/kW	3.90	
				Btu/hW	13.3	
SEER	Cooling			Btu/hW	21.3	
HSPF	Heating				11.7	
Power factor	Cooling			%		
				Heating	98.4	
Moisture removal				pints/h (L/h)	1.5 (0.7)	
Maximum operating current *1	Cooling			A		
				Heating	9.4	
Fan	Airflow rate	Cooling	CFM (m ³ /h)	HIGH	500 (850)	
				MED	400 (680)	
				LOW	347 (590)	
				QUIET	300 (510)	
		Heating	HIGH	500 (850)		
			MED	400 (680)		
			LOW	347 (590)		
			QUIET	300 (510)		
	Type × Q'ty			Sirocco fan × 1		
	Motor output			W	154	
Static pressure range			Pa	30 to 200		
Sound pressure level *2	Cooling		dB (A)	HIGH	35	
				MED	30	
				LOW	27	
				QUIET	24	
	Heating				HIGH	35
					MED	30
					LOW	27
					QUIET	24
Heat exchanger type	Dimensions (H × W × D)		in (mm)	16-9/16 × 18-1/16 × 1-9/16 (420 × 458 × 39.9)		
	Fin pitch		FPI	18		
	Rows × Stages			3 × 20		
	Pipe type			Copper		
	Fin type			Aluminum Hydrophilic coating		
Enclosure	Material		Steel			
	Color		—			
Dimensions (H × W × D)	Net		in (mm)	11-13/16 × 27-9/16 × 27-9/16 (300 × 700 × 700)		
	Gross			15-3/4 × 36-15/16 × 34-7/16 (400 × 938 × 875)		
Weight	Net		lb (kg)	66 (30)		
	Gross			82 (37)		
Connection pipe	Size	Liquid	in (mm)	Ø 1/4 (Ø 6.35)		
		Gas		Ø 3/8 (Ø 9.52)		
Drain hose	Method		Flare			
	Material		PVC			
Operation range	Cooling	in (mm)		Ø 13/16 (20.7) [I.D.], Ø 1-1/16 (26.6) [O.D.] (VP25)		
		°F (°C)		64.4 to 89.6 (18 to 32)		
		%RH		80 or less		
Heating	°F (°C)		60.8 to 86.0 (16 to 30)			

Type	Duct
	Inverter heat pump
Model name	ARU12RGLX
<p>NOTES:</p> <ul style="list-style-type: none"> • Specifications are based on the following conditions: <ul style="list-style-type: none"> – Cooling: Indoor temperature of 80 °FDB/67 °FWB (26.67 °CDB/19.44 °CWB), and outdoor temperature of 95 °FDB/75 °FWB (35 °CDB/23.9 °CWB). – Heating: Indoor temperature of 70 °FDB/59 °FWB (21.11 °CDB/15 °CWB), and outdoor temperature of 47 °FDB/43 °FWB (8.33 °CDB/6.11 °CWB). – Pipe length: 24 ft 7 in (7.5 m), Height difference: 0 ft (0 m). (Between outdoor unit and indoor unit.) – Standard static pressure: 0.18 in.WG (45 Pa) • Protective function might work when using it outside the operation range. • *1: Maximum current: <ul style="list-style-type: none"> – The maximum value when operated within the operation range. – The total current of indoor unit and outdoor unit. • *2: Sound pressure level: <ul style="list-style-type: none"> – Measured values in manufacturer's anechoic chamber. – Because of the surrounding sound environment, the sound levels measured in actual installation conditions might be higher than the specified values here. 	

Type				Duct			
				Inverter heat pump			
Model name				ARU18RGLX	ARU24RGLX	ARU30RGLX	
Power supply				208/230 V ~ 60 Hz			
Power supply intake				Outdoor unit			
Available voltage range				187—253 V			
Capacity	Cooling	Rated	kW	5.28	7.03	8.79	
			Btu/h	18,000	24,000	30,000	
		Min.—Max.	kW	1.58—6.30	1.58—8.5	2.81—10.26	
			Btu/h	5,400—21,500	5,400—29,000	9,600—35,000	
	Heating	47 °FDB (Outdoor temp.)	Rated	kW	6.15	7.91	9.38
			Btu/h	21,000	27,000	32,000	
		Min.—Max.	kW	1.58—7.5	1.58—9.5	2.7—11.43	
			Btu/h	5,400—25,600	5,400—32,400	9,200—39,000	
		17 °FDB (Outdoor temp.)	Rated	kW	4.76	6.07	7.25
			Btu/h	16,200	20,700	24,700	
Input power	Cooling	Rated	kW	1.38	1.90	2.83	
				Min.—Max.	0.53—2.08	0.63—2.82	0.70—3.43
		Heating	47 °FDB (Outdoor temp.)	Rated	1.50	2.06	2.48
				Min.—Max.	0.51—2.19	0.54—2.96	0.62—3.27
	17 °FDB (Outdoor temp.)		Rated	1.49	2.36	2.53	
			Max.	2.17	3.39	3.33	
	Fan	HIGH	W	53	84	139	
				MED	30	44	79
				LOW	22	27	58
				QUIET	15	15	46
	Current	Cooling	Rated	A	6.1	8.3	12.4
		Heating			6.6	9.0	10.9
EER	Cooling	kW/kW	3.81	3.69	3.11		
		Btu/hW	13.0	12.6	10.6		
COP	Heating	kW/kW	4.10	3.84	3.78		
		Btu/hW	14.0	13.1	12.9		
SEER	Cooling	Btu/hW	19.0	17.5	16.5		
HSPF	Heating	Btu/hW	10.9	10.8	10.4		
Power factor	Cooling	%	98.4	99.5	99.2		
	Heating		98.8	99.5	98.9		
Moisture removal			pints/h (L/h)	3.8 (1.8)	4.0 (1.9)	5.1 (2.4)	
Maximum operating current *1	Cooling	A	13.6	15.6	15.6		
	Heating		14.1	16.1	16.1		
Fan	Airflow rate	Cooling	CFM (m ³ /h)	HIGH	618 (1,050)	800 (1,360)	1,001 (1,700)
				MED	494 (840)	636 (1,080)	800 (1,360)
				LOW	430 (730)	518 (880)	700 (1,190)
				QUIET	371 (630)	400 (680)	630 (1,070)
		Heating	HIGH	618 (1,050)	800 (1,360)	1,001 (1,700)	
			MED	494 (840)	636 (1,080)	800 (1,360)	
			LOW	430 (730)	518 (880)	700 (1,190)	
			QUIET	371 (630)	400 (680)	630 (1,070)	
	Type × Q'ty	Sirotco fan × 2					
	Motor output	W		197	375		
Static pressure range	Pa		30 to 200				
Sound pressure level *2	Cooling	dB (A)	HIGH	31	35	38	
			MED	28	30	34	
			LOW	25	28	30	
			QUIET	24	24	29	
	Heating	HIGH	31	35	38		
		MED	28	30	34		
		LOW	25	28	30		
		QUIET	24	24	29		
Heat exchanger type	Dimensions (H × W × D)		in (mm)	16-9/16 × 29-13/16 × 1-9/16 (420 × 758 × 39.9)			
	Fin pitch		FPI	18			
	Rows × Stages			3 × 20			
	Pipe type			Copper			
	Fin type			Aluminum Hydrophilic coating			
Enclosure	Material			Steel			
	Color			—			
Dimensions (H × W × D)	Net		in (mm)	11-13/16 × 39-3/8 × 27-9/16 (300 × 1,000 × 700)			
	Gross			15-3/4 × 48-3/4 × 34-7/16 (400 × 1,238 × 875)			
Weight	Net		lb (kg)	93 (42)			
	Gross			110 (50)			
Connection pipe	Size	Liquid	in (mm)	Ø 1/4 (Ø 6.35)	Ø 3/8 (Ø 9.52)		
		Gas		Ø 1/2 (Ø 12.7)	Ø 5/8 (Ø 15.88)		
Drain hose	Method			Flare			
	Material			PVC			
Operation range	Cooling	°F (°C)	in (mm)	Ø 13/16 (20.7) [I.D.], Ø 1-1/16 (26.6) [O.D.] (VP25)			
				%RH	64.4 to 89.6 (18 to 32)		
Operation range	Heating	°F (°C)	in (mm)	80 or less			
				%RH	60.8 to 86.0 (16 to 30)		

Type	Duct		
	Inverter heat pump		
Model name	ARU18RGLX	ARU24RGLX	ARU30RGLX
<p>NOTES:</p> <ul style="list-style-type: none"> • Specifications are based on the following conditions: <ul style="list-style-type: none"> – Cooling: Indoor temperature of 80 °FDB/67 °FWB (26.67 °CDB/19.44 °CWB), and outdoor temperature of 95 °FDB/75 °FWB (35 °CDB/23.9 °CWB). – Heating: Indoor temperature of 70 °FDB/59 °FWB (21.11 °CDB/15 °CWB), and outdoor temperature of 47 °FDB/43 °FWB (8.33 °CDB/6.11 °CWB). – Pipe length: 24 ft 7 in (7.5 m), Height difference: 0 ft (0 m). (Between outdoor unit and indoor unit.) – Standard static pressure: 0.18 in.WG (45 Pa): 18, and 24 model, 0.23 in.WG (57 Pa): 30 model • Protective function might work when using it outside the operation range. • *1: Maximum current: <ul style="list-style-type: none"> – The maximum value when operated within the operation range. – The total current of indoor unit and outdoor unit. • *2: Sound pressure level: <ul style="list-style-type: none"> – Measured values in manufacturer's anechoic chamber. – Because of the surrounding sound environment, the sound levels measured in actual installation conditions might be higher than the specified values here. 			

Type				Duct								
				Inverter heat pump								
Model name				ARU36RGLX	ARU42RGLX	ARU48RGLX						
Power supply				208/230 V ~ 60 Hz								
Power supply intake				Outdoor unit								
Available voltage range				187—253 V								
Capacity	Cooling	Rated	kW	10.55	12.31	14.07						
			Btu/h	36,000	42,000	48,000						
		Min.—Max.	kW	2.81—11.43	5.01—13.19	5.01—14.65						
			Btu/h	9,600—39,000	17,100—45,000	17,100—50,000						
	Heating	47 °FDB (Outdoor temp.)	Rated	kW	10.55	13.77	15.50					
				Btu/h	36,000	47,000	53,000					
		Min.—Max.	kW	2.7—14.07	5.28—14.95	5.28—16.12						
			Btu/h	9,200—48,000	18,000—51,000	18,000—55,000						
		17 °FDB (Outdoor temp.)	Rated	kW	8.10	11.12	12.00					
				Btu/h	27,600	37,900	40,900					
Max.	kW	10.8	12.07	12.48								
Input power	Cooling	Rated	kW	3.60	3.65	4.75						
			Min.—Max.	0.70—4.00	0.75—4.47	0.75—5.01						
		47 °FDB (Outdoor temp.)	Rated	kW	2.88	3.67	4.45					
				Min.—Max.	0.62—4.38	0.67—4.57	0.67—4.77					
	17 °FDB (Outdoor temp.)	Rated	kW	3.29	3.66	4.44						
			Max.	5.01	4.56	4.76						
	Fan	HIGH	MED	LOW	QUIET	W	COOL: 158	229	248			
							HEAT: 122	132	146			
							94	80	87			
							40	62	66			
	Current	Cooling	Rated	A	15.8	16.0	20.9					
					Heating	12.6	16.1	19.5				
EER	Cooling	kW/kW	2.93	3.37	2.96							
			Btu/hW	10.0	11.5	10.1						
COP	Heating	kW/kW	3.66	3.75	3.49							
			Btu/hW	12.5	12.8	11.9						
SEER	Cooling	Btu/hW	16.7	17.8	16.6							
HSPF	Heating	Btu/hW	11.3	10.5	10.3							
Power factor	Cooling	kW/kW	99.1	99.2	98.8							
			Heating	99.4	99.1	99.2						
Moisture removal			pints/h (L/h)	5.3 (2.5)	5.5 (2.6)	8.2 (3.9)						
Maximum operating current *1	Cooling	Heating	A	17.6	19.7	22.2						
				19.1	19.7	20.7						
Fan	Airflow rate	Cooling	HIGH	MED	LOW	QUIET	CFM (m³/h)	1,207 (2,050)	1,501 (2,550)	1,501 (2,550)		
								965 (1,640)	1,201 (2,040)	1,201 (2,040)		
								783 (1,330)	971 (1,650)	971 (1,650)		
								630 (1,070)	842 (1,430)	842 (1,430)		
		Heating	HIGH	MED	LOW	QUIET	1,089 (1,850)	1,501 (2,550)	1,501 (2,550)			
							965 (1,640)	1,201 (2,040)	1,201 (2,040)			
							783 (1,330)	971 (1,650)	971 (1,650)			
							630 (1,070)	842 (1,430)	842 (1,430)			
	Type × Q'ty	Sirocco fan × 3										
	Motor output	W		375								
Static pressure range			Pa	30 to 200	30 to 180							
Sound pressure level *2	Cooling	HIGH	MED	LOW	QUIET	dB (A)	37	40	40			
							33	35	35			
							30	33	33			
							26	29	29			
	Heating	HIGH	MED	LOW	QUIET	35	40	40				
						33	35	35				
						30	33	33				
						26	29	29				
						Heat exchanger type			Dimensions (H × W × D)	16-9/16 × 45-9/16 × 1-9/16 (420 × 1,158 × 39.9)		
									Fin pitch	FPI		
			Rows × Stages	18								
			Pipe type	3 × 20								
			Fin type	Copper								
			Material	Aluminum								
			Color	Hydrophilic coating								
			Material	Steel								
			Color	—								
Dimensions (H × W × D)	Net	Gross	in (mm)	11-13/16 × 55-1/8 × 27-9/16 (300 × 1,400 × 700)								
				15-3/4 × 64-1/2 × 34-7/16 (400 × 1,638 × 875)								
Weight	Net	Gross	lb (kg)	121 (55)								
				141 (64)								
Connection pipe	Size	Liquid	Gas	in (mm)	Ø 3/8 (Ø 9.52)							
					Ø 5/8 (Ø 15.88)							
			Method									
			Flare									
			PVC									
			PVC									
			Size									
			in (mm)									
			Ø 13/16 (20.7) [I.D.], Ø 1-1/16 (26.6) [O.D.] (VP25)									
Operation range	Cooling	Heating	°F (°C)	64.4 to 89.6 (18 to 32)								
				%RH								
				80 or less								
			°F (°C)									
			60.8 to 86.0 (16 to 30)									

Type	Duct		
	Inverter heat pump		
Model name	ARU36RGLX	ARU42RGLX	ARU48RGLX
<p>NOTES:</p> <ul style="list-style-type: none"> • Specifications are based on the following conditions: <ul style="list-style-type: none"> – Cooling: Indoor temperature of 80 °FDB/67 °FWB (26.67 °CDB/19.44 °CWB), and outdoor temperature of 95 °FDB/75 °FWB (35 °CDB/23.9 °CWB). – Heating: Indoor temperature of 70 °FDB/59 °FWB (21.11 °CDB/15 °CWB), and outdoor temperature of 47 °FDB/43 °FWB (8.33 °CDB/6.11 °CWB). – Pipe length: 24 ft 7 in (7.5 m), Height difference: 0 ft (0 m). (Between outdoor unit and indoor unit.) – Standard static pressure: 0.23 in.WG (57 Pa): 36 and 42 model, 0.28 in.WG (70 Pa): 48 model • Protective function might work when using it outside the operation range. • *1: Maximum current: <ul style="list-style-type: none"> – The maximum value when operated within the operation range. – The total current of indoor unit and outdoor unit. • *2: Sound pressure level: <ul style="list-style-type: none"> – Measured values in manufacturer's anechoic chamber. – Because of the surrounding sound environment, the sound levels measured in actual installation conditions might be higher than the specified values here. 			

2. Dimensions

2-1. Model: ARU12RGLX

Unit: in (mm)

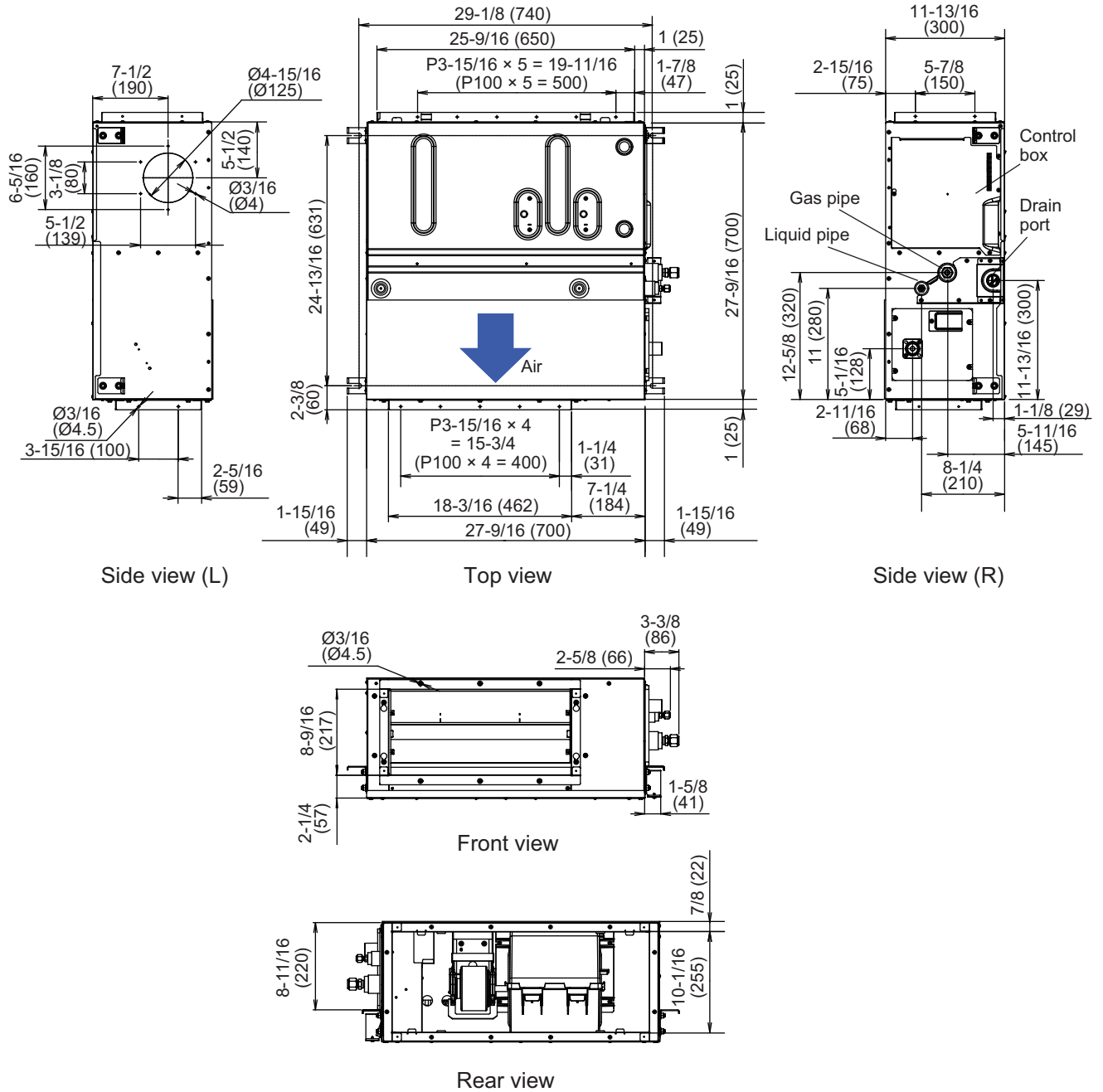

2-2. Models: ARU18RGLX, ARU24RGLX, and ARU30RGLX

Unit: in (mm)

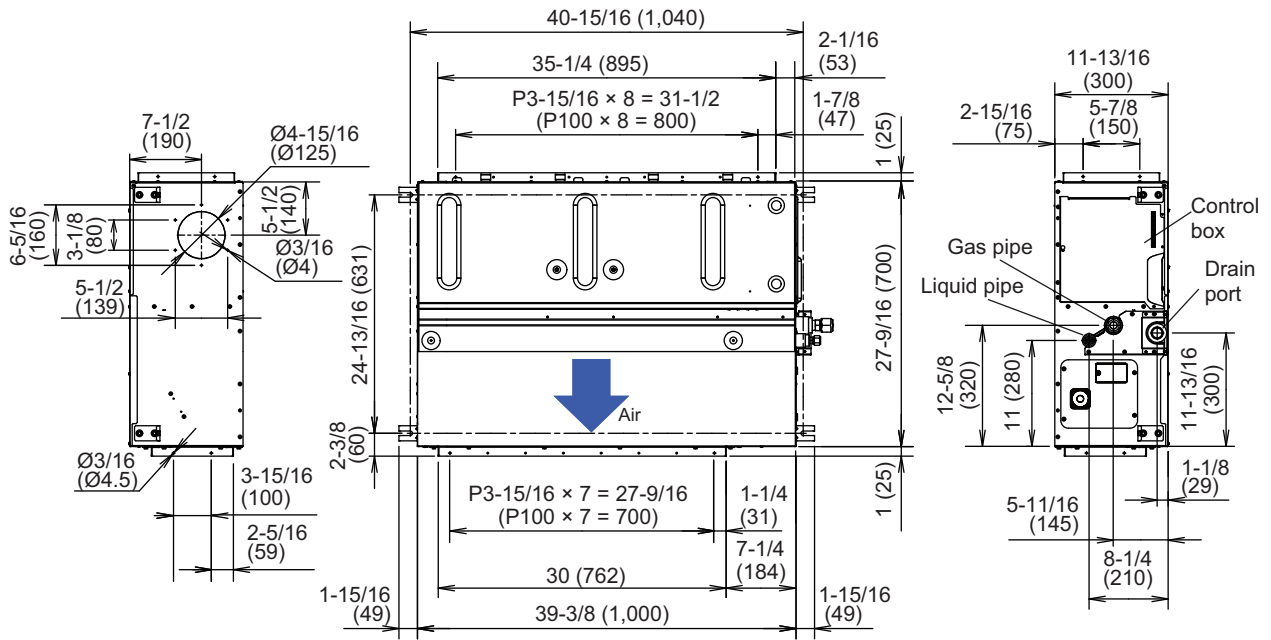

Side view (L)

Top view

Side view (R)

Front view

Rear view

2-3. Models: ARU36RGLX, ARU42RGLX, and ARU48RGLX

DUCT TYPE
ARU12-48RGLX

DUCT TYPE
ARU12-48RGLX

Unit: in (mm)

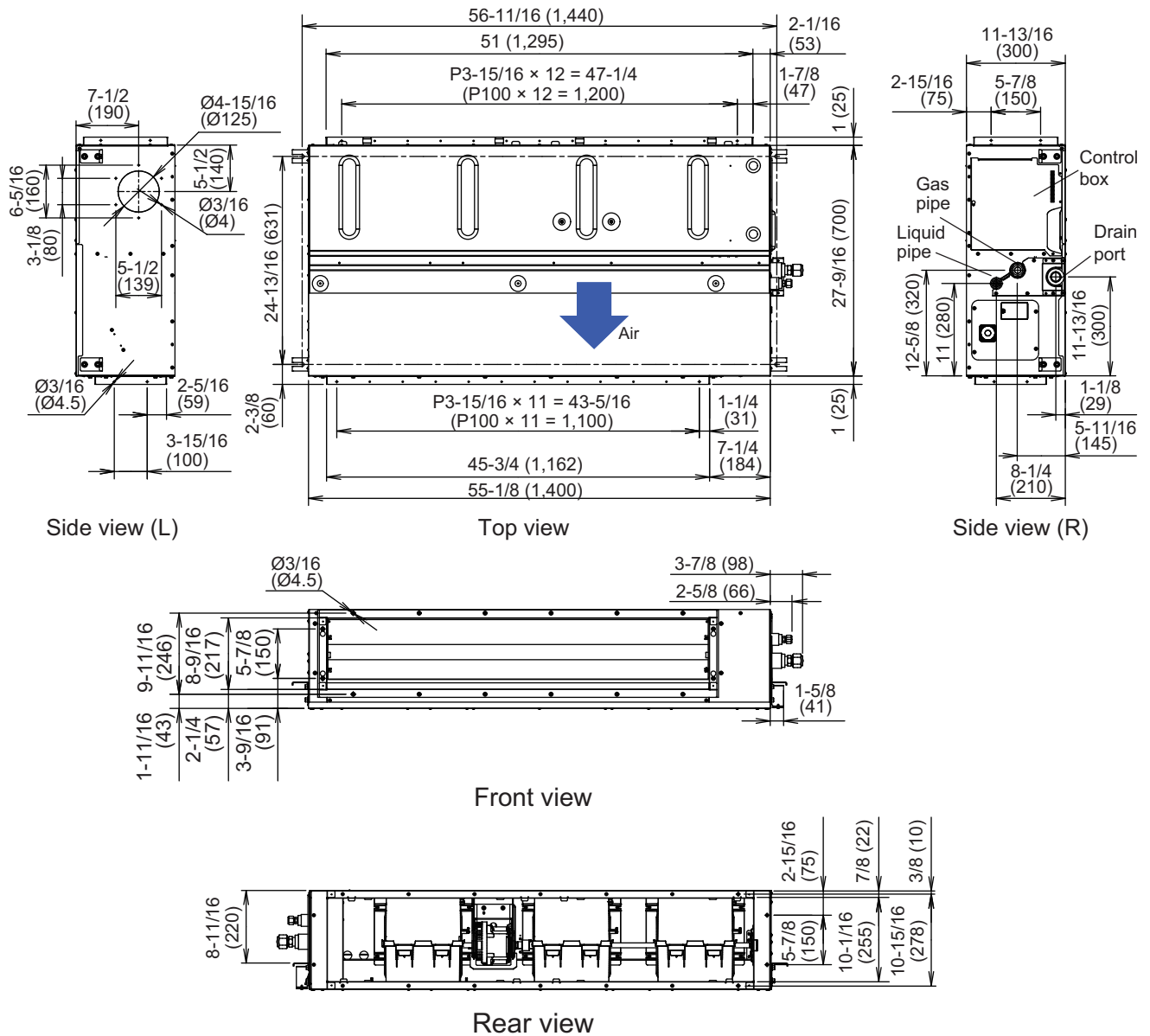

2-4. Installation space requirement

Provide sufficient installation space for product safety.

- **Models: ARU12RGLX, ARU18RGLX, ARU24RGLX, ARU30RGLX, ARU36RGLX, ARU42RGLX, and ARU48RGLX**

Unit: in (mm)

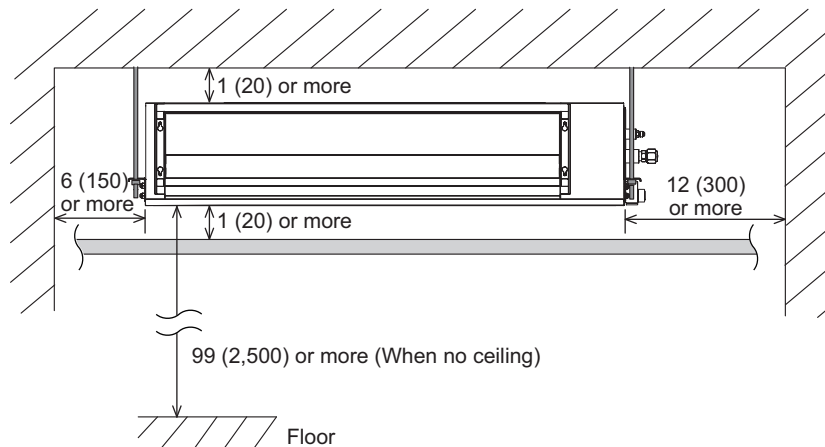

2-5. Maintenance space requirement

For future maintenance and service access, provide sufficient maintenance space.

NOTE: Do not place any wiring or illumination in the maintenance space, as they will impede service.

■ Models: ARU12RGLX, ARU18RGLX, ARU24RGLX, ARU30RGLX, ARU36RGLX, ARU42RGLX, and ARU48RGLX

Unit: in (mm)

- Provide a service access for maintenance purposes.

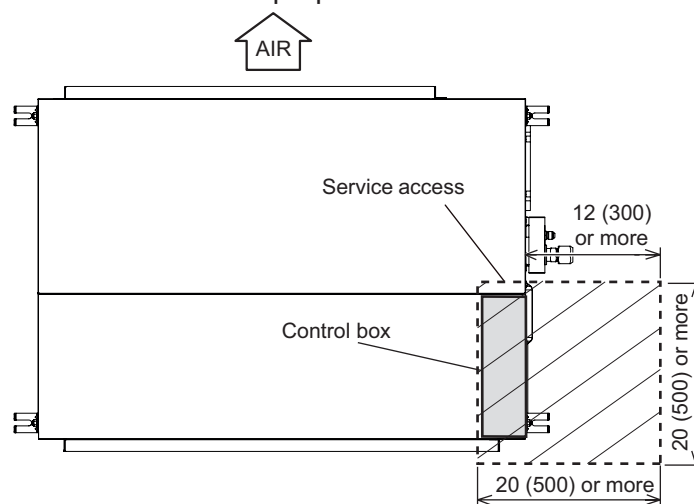

Bottom view

- The service access necessary for fan units and filter maintenance.

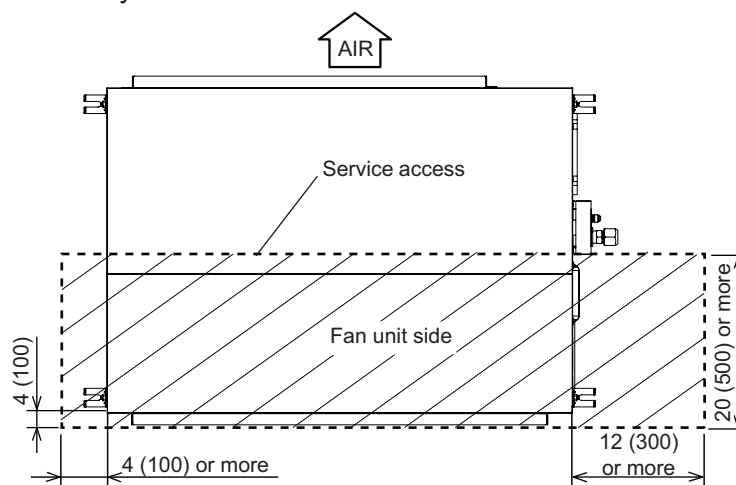

Bottom view

3. Wiring diagrams

3-1. Models: ARU12RGLX, ARU18RGLX, and ARU24RGLX

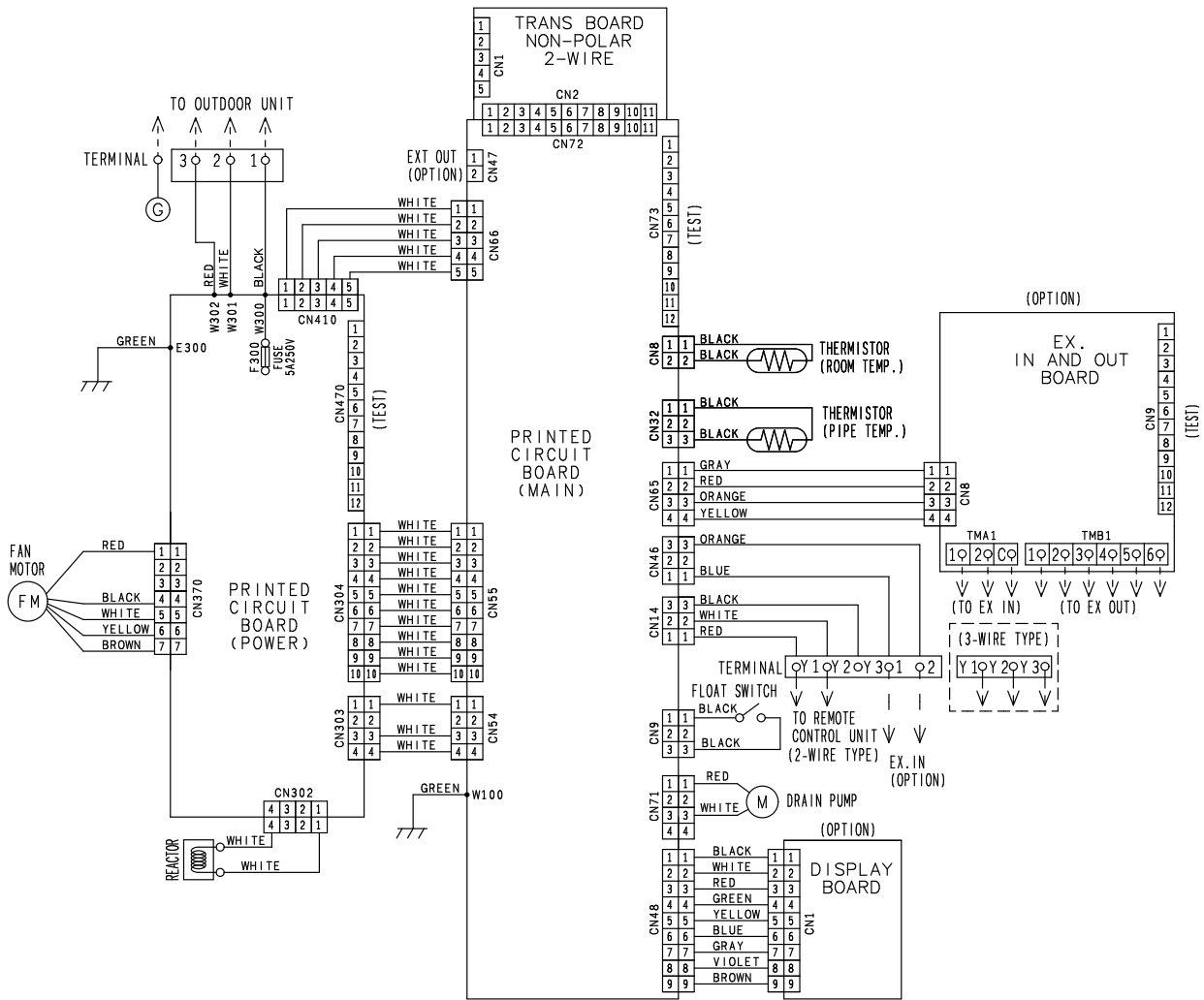

3-2. Models: ARU30RGLX, ARU36RGLX, ARU42RGLX, and ARU48RGLX

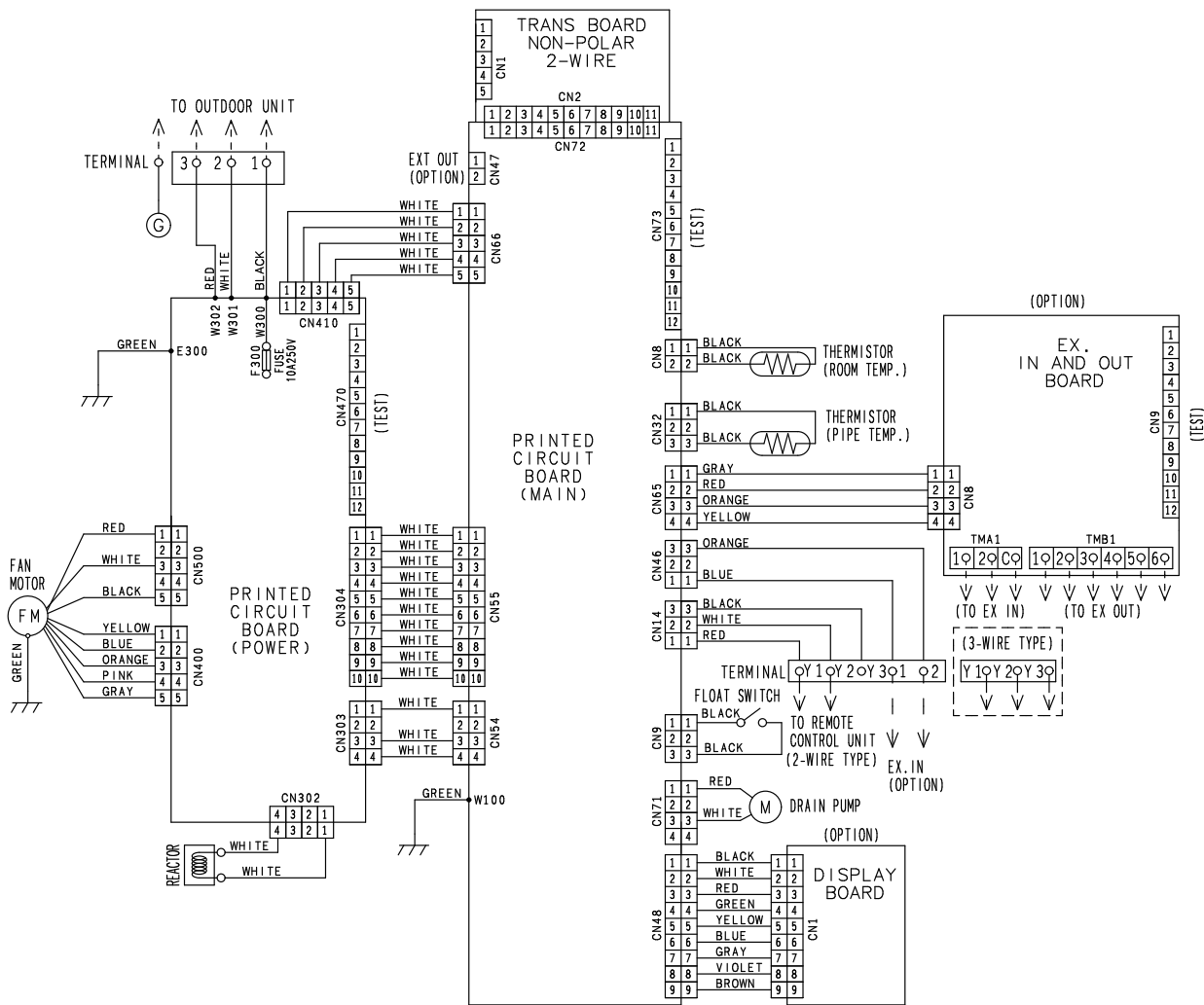

4. Capacity table

Capacity tables show each of following values calculated based on the outdoor temperature and the indoor temperature, under given Airflow Rate (AFR):

For cooling capacity: Total Capacity (TC), Sensible Heat Capacity (SHC), and Input Power (IP)

For heating capacity: Total Capacity (TC) and Input Power (IP)

4-1. Cooling capacity

■ Model: ARU12RGLX

AFR	CFM	500
-----	-----	-----

Outdoor temperature	Indoor temperature																							
	64			70			75			80			85			90								
	54			60			63			67			71			73								
	°FDB	TC	SHC	IP	TC	SHC	IP	TC	SHC	IP	TC	SHC	IP	TC	SHC	IP	TC	SHC	IP					
	kBTu/h			kW			kBTu/h			kW			kBTu/h			kW			kBTu/h			kW		
14	11.33	9.17	0.32	12.80	10.38	0.32	13.48	10.93	0.32	14.43	11.71	0.33	15.42	12.49	0.33	15.93	12.92	0.33						
23	11.05	9.13	0.37	12.52	10.34	0.38	13.20	10.89	0.38	14.16	11.67	0.38	15.08	12.45	0.39	15.56	12.84	0.39						
32	10.85	9.02	0.41	12.25	10.19	0.41	12.93	10.77	0.42	13.85	11.52	0.42	14.77	12.30	0.43	15.25	12.69	0.43						
41	10.61	8.86	0.43	12.01	10.03	0.44	12.66	10.58	0.44	13.58	11.32	0.45	14.47	12.06	0.45	14.94	12.45	0.45						
50	10.41	8.63	0.43	11.77	9.76	0.44	12.42	10.31	0.44	13.27	11.05	0.45	14.16	11.79	0.45	14.64	12.18	0.45						
59	10.17	7.96	0.44	11.50	8.98	0.45	12.15	9.49	0.45	13.00	10.15	0.45	13.85	10.81	0.46	14.33	11.20	0.46						
67	11.46	9.72	0.71	12.97	9.72	0.72	13.68	10.70	0.73	14.64	11.24	0.74	15.63	11.48	0.75	16.14	12.76	0.75						
77	10.88	9.37	0.80	12.32	9.37	0.81	12.97	10.34	0.82	13.89	10.85	0.83	14.84	11.09	0.84	15.32	12.34	0.84						
87	10.17	9.02	0.86	11.50	9.02	0.88	12.11	9.92	0.88	12.97	10.42	0.89	13.85	10.66	0.90	14.30	11.87	0.91						
95	9.42	8.67	0.86	10.65	8.67	0.87	11.19	9.56	0.88	12.00	10.03	0.89	12.83	10.27	0.90	13.24	11.40	0.91						
104	7.92	8.00	0.72	8.94	8.00	0.74	9.42	8.82	0.74	10.10	9.25	0.75	10.78	9.49	0.76	11.12	10.54	0.77						
115	7.30	7.42	0.73	8.26	7.42	0.74	8.70	8.20	0.75	9.31	8.59	0.76	9.96	8.78	0.77	10.27	9.76	0.77						

AFR	m ³ /h	850
-----	-------------------	-----

Outdoor temperature	Indoor temperature																						
	17.8			21.1			23.9			26.7			29.4			32.2							
	12.2			15.6			17.2			19.4			21.7			22.8							
	°CDB	TC	SHC	IP	TC	SHC	IP	TC	SHC	IP	TC	SHC	IP	TC	SHC	IP	TC	SHC	IP				
	kW			kW			kW			kW			kW			kW			kW				
-10	3.32	2.69	0.32	3.75	3.04	0.32	3.95	3.20	0.32	4.23	3.43	0.33	4.52	3.66	0.33	4.67	3.79	0.33					
-5	3.24	2.68	0.37	3.67	3.03	0.38	3.87	3.19	0.38	4.15	3.42	0.38	4.42	3.65	0.39	4.56	3.76	0.39					
0	3.18	2.64	0.41	3.59	2.99	0.41	3.79	3.16	0.42	4.06	3.38	0.42	4.33	3.60	0.43	4.47	3.72	0.43					
5	3.11	2.60	0.43	3.52	2.94	0.44	3.71	3.10	0.44	3.98	3.32	0.45	4.24	3.54	0.45	4.38	3.65	0.45					
10	3.05	2.53	0.43	3.45	2.86	0.44	3.64	3.02	0.44	3.89	3.24	0.45	4.15	3.46	0.45	4.29	3.57	0.45					
15	2.98	2.33	0.44	3.37	2.63	0.45	3.56	2.78	0.45	3.81	2.97	0.45	4.06	3.17	0.46	4.20	3.28	0.46					
19.4	3.36	2.85	0.71	3.80	2.85	0.72	4.01	3.13	0.73	4.29	3.29	0.74	4.58	3.36	0.75	4.73	3.74	0.75					
25	3.19	2.75	0.80	3.61	2.75	0.81	3.80	3.03	0.82	4.07	3.18	0.83	4.35	3.25	0.84	4.49	3.62	0.84					
30.6	2.98	2.64	0.86	3.37	2.64	0.88	3.55	2.91	0.88	3.80	3.05	0.89	4.06	3.12	0.90	4.19	3.48	0.91					
35	2.76	2.54	0.86	3.12	2.54	0.87	3.28	2.80	0.88	3.52	2.94	0.89	3.76	3.01	0.90	3.88	3.34	0.91					
40	2.32	2.35	0.72	2.62	2.35	0.74	2.76	2.59	0.74	2.96	2.71	0.75	3.16	2.78	0.76	3.26	3.09	0.77					
46	2.14	2.17	0.73	2.42	2.17	0.74	2.55	2.40	0.75	2.73	2.52	0.76	2.92	2.57	0.77	3.01	2.86	0.77					

Model: ARU18RGLX

DUCT TYPE
ARU12-48RGLXDUCT TYPE
ARU12-48RGLX

AFR	CFM	618
-----	-----	-----

		Indoor temperature																	
		64			70			75			80			85			90		
		54			60			63			67			71			73		
Outdoor temperature	°FDB	TC	SHC	IP	TC	SHC	IP	TC	SHC	IP	TC	SHC	IP	TC	SHC	IP	TC	SHC	IP
		kBTu/h			kW			kBTu/h			kW			kBTu/h			kW		
		kW			kW			kW			kW			kW			kW		
	-5	15.88	12.89	0.36	17.68	12.97	0.36	18.88	14.12	0.35	20.08	15.26	0.35	21.29	15.20	0.35	22.51	16.19	0.35
	5	15.54	12.78	0.58	17.29	12.86	0.59	18.47	14.00	0.60	19.65	15.14	0.60	20.83	15.07	0.61	22.02	16.06	0.61
	14	15.28	12.31	0.73	17.00	12.37	0.74	18.17	13.48	0.75	19.33	14.60	0.76	20.47	14.52	0.77	21.66	15.46	0.78
	32	14.56	12.20	0.93	16.21	12.26	0.94	17.32	13.37	0.95	18.42	14.46	0.96	19.52	14.40	0.97	20.62	15.34	0.98
	41	14.37	11.92	0.93	16.02	11.98	0.95	17.10	13.04	0.96	18.21	14.11	0.97	19.29	14.05	0.97	20.37	14.97	0.99
	50	14.31	12.08	0.94	15.92	12.16	0.96	17.02	13.25	0.96	18.10	14.32	0.97	19.18	14.27	0.98	20.26	15.20	0.99
	59	15.56	12.51	1.03	17.32	12.61	1.05	18.50	13.73	1.06	19.67	14.85	1.07	20.86	14.79	1.08	22.04	15.75	1.09
	67	17.36	13.13	1.23	19.35	13.21	1.25	20.66	14.37	1.27	22.00	15.55	1.28	23.31	15.48	1.29	24.63	16.49	1.30
	77	17.06	13.15	1.33	19.01	13.23	1.34	20.30	14.41	1.36	21.60	15.59	1.37	22.89	15.53	1.39	24.20	16.53	1.40
	86	15.81	12.82	1.34	17.61	12.90	1.37	18.81	14.04	1.38	20.01	15.18	1.40	21.22	15.14	1.41	22.42	16.12	1.42
	95	14.24	11.92	1.33	15.85	11.98	1.35	16.95	13.04	1.37	18.00	14.11	1.38	19.10	14.05	1.40	20.18	14.97	1.41
	104	10.81	9.91	1.16	12.04	9.99	1.17	12.85	10.85	1.19	13.69	11.75	1.20	14.50	11.69	1.21	15.32	12.47	1.22
	115	9.66	8.55	1.15	10.75	8.61	1.16	11.48	9.37	1.17	12.21	10.13	1.19	12.95	10.09	1.20	13.67	10.75	1.21

AFR	m ³ /h	1,050
-----	-------------------	-------

		Indoor temperature																	
		17.8			21.1			23.9			26.7			29.4			32.2		
		12.2			15.6			17.2			19.4			21.7			22.8		
Outdoor temperature	°CDB	TC	SHC	IP	TC	SHC	IP	TC	SHC	IP	TC	SHC	IP	TC	SHC	IP	TC	SHC	IP
		kW			kW			kW			kW			kW			kW		
		kW			kW			kW			kW			kW			kW		
	-20.6	4.65	3.78	0.36	5.18	3.80	0.36	5.53	4.14	0.35	5.89	4.47	0.35	6.24	4.46	0.35	6.60	4.75	0.35
	-15	4.55	3.74	0.58	5.07	3.77	0.59	5.41	4.10	0.60	5.76	4.44	0.60	6.11	4.42	0.61	6.45	4.71	0.61
	-10	4.48	3.61	0.73	4.98	3.62	0.74	5.33	3.95	0.75	5.67	4.28	0.76	6.00	4.26	0.77	6.35	4.53	0.78
	0	4.27	3.58	0.93	4.75	3.59	0.94	5.08	3.92	0.95	5.40	4.24	0.96	5.72	4.22	0.97	6.04	4.50	0.98
	5	4.21	3.49	0.93	4.70	3.51	0.95	5.01	3.82	0.96	5.34	4.14	0.97	5.65	4.12	0.97	5.97	4.39	0.99
	10	4.19	3.54	0.94	4.67	3.56	0.96	4.99	3.88	0.96	5.30	4.20	0.97	5.62	4.18	0.98	5.94	4.45	0.99
	15	4.56	3.67	1.03	5.08	3.70	1.05	5.42	4.02	1.06	5.76	4.35	1.07	6.11	4.33	1.08	6.46	4.62	1.09
	19.4	5.09	3.85	1.23	5.67	3.87	1.25	6.06	4.21	1.27	6.45	4.56	1.28	6.83	4.54	1.29	7.22	4.83	1.30
	25	5.00	3.85	1.33	5.57	3.88	1.34	5.95	4.22	1.36	6.33	4.57	1.37	6.71	4.55	1.39	7.09	4.84	1.40
	30	4.63	3.76	1.34	5.16	3.78	1.37	5.51	4.11	1.38	5.86	4.45	1.40	6.22	4.44	1.41	6.57	4.72	1.42
	35	4.17	3.49	1.33	4.65	3.51	1.35	4.97	3.82	1.37	5.28	4.14	1.38	5.60	4.12	1.40	5.91	4.39	1.41
	40	3.17	2.90	1.16	3.53	2.93	1.17	3.77	3.18	1.19	4.01	3.44	1.20	4.25	3.43	1.21	4.49	3.65	1.22
	46.1	2.83	2.51	1.15	3.15	2.52	1.16	3.36	2.75	1.17	3.58	2.97	1.19	3.80	2.96	1.20	4.01	3.15	1.21

Model: ARU24RGLX

DUCT TYPE
ARU12-48RGLXDUCT TYPE
ARU12-48RGLX

AFR	CFM	800
-----	-----	-----

		Indoor temperature																	
		64			70			75			80			85			90		
		54			60			63			67			71			73		
Outdoor temperature	°FDB	TC	SHC	IP	TC	SHC	IP	TC	SHC	IP	TC	SHC	IP	TC	SHC	IP	TC	SHC	IP
	°FWB	kBTu/h			kBTu/h			kBTu/h			kBTu/h			kBTu/h			kBTu/h		
		kW			kW			kW			kW			kW			kW		
	-5	19.04	14.82	0.43	21.23	14.89	0.43	22.68	16.22	0.43	24.13	17.55	0.44	25.56	17.48	0.44	27.02	18.61	0.45
	5	18.63	14.81	0.67	20.77	14.88	0.68	22.19	16.20	0.68	23.60	17.53	0.69	25.01	17.46	0.70	26.44	18.59	0.70
	14	18.32	14.46	0.83	20.41	14.55	0.84	21.79	15.86	0.85	23.20	17.14	0.86	24.60	17.07	0.87	25.98	18.18	0.87
	32	17.30	14.53	1.05	19.27	14.60	1.06	20.59	15.90	1.07	21.92	17.21	1.08	23.25	17.14	1.09	24.55	18.25	1.11
	41	17.28	14.30	1.06	19.27	14.39	1.07	20.55	15.66	1.09	21.87	16.95	1.09	23.17	16.88	1.11	24.50	17.99	1.12
	50	17.20	14.55	1.06	19.14	14.62	1.08	20.45	15.94	1.09	21.77	17.25	1.10	23.07	17.16	1.11	24.37	18.29	1.12
	59	18.47	14.90	1.17	20.59	14.99	1.18	22.00	16.32	1.20	23.40	17.65	1.21	24.80	17.58	1.22	26.21	18.73	1.24
	67	20.77	15.66	1.39	23.14	15.75	1.41	24.71	17.16	1.42	26.31	18.57	1.44	27.89	18.50	1.45	29.45	19.70	1.46
	77	20.46	15.71	1.54	22.79	15.80	1.56	24.33	17.22	1.57	25.90	18.61	1.59	27.43	18.55	1.60	28.99	19.74	1.62
86	20.01	15.57	1.83	22.30	15.64	1.85	23.81	17.05	1.87	25.34	18.43	1.89	26.84	18.36	1.91	28.38	19.56	1.93	
95	18.96	15.36	1.83	21.13	15.45	1.86	22.53	16.84	1.88	24.00	18.22	1.90	25.42	18.13	1.92	26.84	19.33	1.94	
104	14.06	11.56	1.42	15.67	11.63	1.44	16.73	12.65	1.46	17.79	13.68	1.47	18.86	13.63	1.48	19.93	14.53	1.50	
115	12.63	11.23	1.37	14.06	11.30	1.39	15.03	12.31	1.40	15.97	13.31	1.42	16.94	13.26	1.42	17.91	14.12	1.44	

AFR	m ³ /h	1,360
-----	-------------------	-------

		Indoor temperature																	
		17.8			21.1			23.9			26.7			29.4			32.2		
		12.2			15.6			17.2			19.4			21.7			22.8		
Outdoor temperature	°CDB	TC	SHC	IP	TC	SHC	IP	TC	SHC	IP	TC	SHC	IP	TC	SHC	IP	TC	SHC	IP
	°CWB	kW			kW			kW			kW			kW			kW		
		kW			kW			kW			kW			kW			kW		
	-20.6	5.58	4.34	0.43	6.22	4.36	0.43	6.65	4.75	0.43	7.07	5.14	0.44	7.49	5.12	0.44	7.92	5.45	0.45
	-15	5.46	4.34	0.67	6.09	4.36	0.68	6.50	4.75	0.68	6.92	5.14	0.69	7.33	5.12	0.70	7.75	5.45	0.70
	-10	5.37	4.24	0.83	5.98	4.27	0.84	6.39	4.65	0.85	6.80	5.02	0.86	7.21	5.00	0.87	7.61	5.33	0.87
	0	5.07	4.26	1.05	5.65	4.28	1.06	6.04	4.66	1.07	6.42	5.04	1.08	6.81	5.02	1.09	7.19	5.35	1.11
	5	5.06	4.19	1.06	5.65	4.22	1.07	6.02	4.59	1.09	6.41	4.97	1.09	6.79	4.95	1.11	7.18	5.27	1.12
	10	5.04	4.27	1.06	5.61	4.29	1.08	5.99	4.67	1.09	6.38	5.06	1.10	6.76	5.03	1.11	7.14	5.36	1.12
	15	5.41	4.37	1.17	6.04	4.39	1.18	6.45	4.78	1.20	6.86	5.17	1.21	7.27	5.15	1.22	7.68	5.49	1.24
	19.4	6.09	4.59	1.39	6.78	4.62	1.41	7.24	5.03	1.42	7.71	5.44	1.44	8.17	5.42	1.45	8.63	5.77	1.46
	25	6.00	4.60	1.54	6.68	4.63	1.56	7.13	5.05	1.57	7.59	5.46	1.59	8.04	5.44	1.60	8.50	5.79	1.62
30	5.86	4.56	1.83	6.54	4.58	1.85	6.98	5.00	1.87	7.43	5.40	1.89	7.87	5.38	1.91	8.32	5.73	1.93	
35	5.56	4.50	1.83	6.19	4.53	1.86	6.60	4.94	1.88	7.03	5.34	1.90	7.45	5.31	1.92	7.87	5.67	1.94	
40	4.12	3.39	1.42	4.59	3.41	1.44	4.90	3.71	1.46	5.21	4.01	1.47	5.53	4.00	1.48	5.84	4.26	1.50	
46.1	3.70	3.29	1.37	4.12	3.31	1.39	4.40	3.61	1.40	4.68	3.90	1.42	4.97	3.89	1.42	5.25	4.14	1.44	

Model: ARU30RGLX

DUCT TYPE
ARU12-48RGLXDUCT TYPE
ARU12-48RGLX

AFR	CFM	1,001
-----	-----	-------

		Indoor temperature																	
		64			70			75			80			85			90		
		54			60			63			67			71			73		
Outdoor temperature	°FDB	TC	SHC	IP	TC	SHC	IP	TC	SHC	IP	TC	SHC	IP	TC	SHC	IP	TC	SHC	IP
	°FWB	kBTu/h			kBTu/h			kBTu/h			kBTu/h			kBTu/h			kBTu/h		
	°FDB	kW			kW			kW			kW			kW			kW		
	-5	26.44	20.40	0.76	29.43	20.53	0.75	31.43	22.35	0.74	33.43	24.16	0.73	35.45	24.07	0.74	37.47	25.64	0.74
	5	25.86	20.23	1.20	28.79	20.36	1.21	30.75	22.16	1.23	32.71	23.96	1.24	34.68	23.87	1.25	36.66	25.42	1.26
	14	25.44	19.48	1.51	28.30	19.58	1.53	30.26	21.35	1.54	32.18	23.12	1.56	34.08	22.99	1.57	36.06	24.48	1.59
	32	24.24	19.32	1.90	26.99	19.42	1.93	28.83	21.17	1.95	30.66	22.89	1.96	32.50	22.79	2.00	34.33	24.29	2.01
	41	23.92	18.87	1.91	26.67	18.96	1.94	28.47	20.65	1.96	30.31	22.34	1.99	32.11	22.24	2.00	33.91	23.70	2.03
	50	23.82	19.12	1.93	26.50	19.25	1.96	28.33	20.98	1.98	30.13	22.66	2.00	31.93	22.60	2.02	33.73	24.06	2.04
	59	25.90	19.81	2.11	28.83	19.97	2.16	30.80	21.74	2.18	32.74	23.51	2.20	34.72	23.41	2.22	36.70	24.94	2.24
67	28.90	20.78	2.52	32.21	20.91	2.56	34.40	22.75	2.60	36.62	24.61	2.62	38.81	24.52	2.64	41.00	26.11	2.67	
77	28.40	20.81	2.72	31.65	20.94	2.76	33.80	22.81	2.79	35.95	24.68	2.82	38.11	24.58	2.84	40.29	26.17	2.87	
86	26.32	20.29	2.76	29.32	20.42	2.81	31.31	22.23	2.83	33.31	24.03	2.86	35.32	23.96	2.89	37.33	25.52	2.92	
95	23.71	18.87	2.73	26.39	18.96	2.78	28.21	20.65	2.80	30.00	22.34	2.83	31.79	22.24	2.86	33.59	23.70	2.89	
104	17.99	15.68	2.38	20.04	15.81	2.40	21.40	17.18	2.43	22.79	18.61	2.47	24.13	18.51	2.49	25.51	19.74	2.51	
115	16.09	13.54	2.35	17.89	13.64	2.38	19.11	14.84	2.40	20.32	16.04	2.43	21.56	15.98	2.46	22.76	17.01	2.48	

AFR	m ³ /h	1,700
-----	-------------------	-------

		Indoor temperature																	
		17.8			21.1			23.9			26.7			29.4			32.2		
		12.2			15.6			17.2			19.4			21.7			22.8		
Outdoor temperature	°CDB	TC	SHC	IP	TC	SHC	IP	TC	SHC	IP	TC	SHC	IP	TC	SHC	IP	TC	SHC	IP
	°CWB	kW			kW			kW			kW			kW			kW		
	-20.6	7.75	5.98	0.76	8.63	6.02	0.75	9.21	6.55	0.74	9.80	7.08	0.73	10.39	7.05	0.74	10.98	7.51	0.74
	-15	7.58	5.93	1.20	8.44	5.97	1.21	9.01	6.50	1.23	9.59	7.02	1.24	10.17	6.99	1.25	10.74	7.45	1.26
	-10	7.46	5.71	1.51	8.29	5.74	1.53	8.87	6.26	1.54	9.43	6.78	1.56	9.99	6.74	1.57	10.57	7.18	1.59
	0	7.10	5.66	1.90	7.91	5.69	1.93	8.45	6.20	1.95	8.99	6.71	1.96	9.52	6.68	2.00	10.06	7.12	2.01
	5	7.01	5.53	1.91	7.82	5.56	1.94	8.35	6.05	1.96	8.88	6.55	1.99	9.41	6.52	2.00	9.94	6.95	2.03
	10	6.98	5.61	1.93	7.77	5.64	1.96	8.30	6.15	1.98	8.83	6.64	2.00	9.36	6.62	2.02	9.89	7.05	2.04
	15	7.59	5.81	2.11	8.45	5.85	2.16	9.03	6.37	2.18	9.60	6.89	2.20	10.18	6.86	2.22	10.75	7.31	2.24
	19.4	8.47	6.09	2.52	9.44	6.13	2.56	10.08	6.67	2.60	10.73	7.21	2.62	11.38	7.18	2.64	12.02	7.65	2.67
25	8.32	6.10	2.72	9.28	6.14	2.76	9.91	6.69	2.79	10.54	7.23	2.82	11.17	7.20	2.84	11.81	7.67	2.87	
30	7.71	5.95	2.76	8.59	5.99	2.81	9.18	6.51	2.83	9.76	7.04	2.86	10.35	7.02	2.89	10.94	7.48	2.92	
35	6.95	5.53	2.73	7.74	5.56	2.78	8.27	6.05	2.80	8.79	6.55	2.83	9.32	6.52	2.86	9.84	6.95	2.89	
40	5.27	4.60	2.38	5.87	4.63	2.40	6.27	5.03	2.43	6.68	5.45	2.47	7.07	5.42	2.49	7.48	5.79	2.51	
46.1	4.72	3.97	2.35	5.24	4.00	2.38	5.60	4.35	2.40	5.96	4.70	2.43	6.32	4.68	2.46	6.67	4.99	2.48	

Model: ARU36RGLX

AFR	CFM	1,207
-----	-----	-------

		Indoor temperature																	
		64			70			75			80			85			90		
		54			60			63			67			71			73		
Outdoor temperature	°FDB	TC	SHC	IP	TC	SHC	IP	TC	SHC	IP	TC	SHC	IP	TC	SHC	IP	TC	SHC	IP
	°FWB	kBTu/h			kBTu/h			kBTu/h			kBTu/h			kBTu/h			kBTu/h		
		kW			kW			kW			kW			kW			kW		
	-5	30.62	25.34	0.59	34.14	25.45	0.60	34.04	24.26	0.78	36.21	26.25	0.78	38.36	26.15	0.79	40.56	27.84	0.80
	5	27.95	22.15	1.27	31.17	22.26	1.28	33.30	24.24	1.30	35.42	26.23	1.31	37.53	26.12	1.32	39.67	27.81	1.34
	14	27.50	21.64	1.56	30.64	21.78	1.59	32.70	23.72	1.61	34.81	25.64	1.63	36.92	25.54	1.64	38.98	27.19	1.65
	32	25.96	21.74	1.98	28.91	21.84	2.01	30.90	23.79	2.03	32.89	25.74	2.05	34.89	25.64	2.07	36.84	27.30	2.10
	41	25.93	21.40	2.01	28.91	21.53	2.04	30.85	23.43	2.06	32.82	25.36	2.07	34.77	25.26	2.10	36.76	26.92	2.12
	50	25.81	21.78	2.01	28.72	21.88	2.05	30.69	23.85	2.07	32.66	25.81	2.09	34.62	25.67	2.10	36.57	27.37	2.12
	59	27.73	22.29	2.21	30.90	22.43	2.24	33.01	24.42	2.26	35.12	26.40	2.29	37.22	26.30	2.32	39.33	28.02	2.34
67	31.17	23.43	2.63	34.73	23.57	2.67	37.09	25.67	2.70	39.48	27.78	2.72	41.86	27.68	2.75	44.19	29.47	2.77	
77	30.71	23.50	2.91	34.20	23.64	2.95	36.51	25.76	2.98	38.87	27.85	3.01	41.17	27.75	3.04	43.50	29.54	3.08	
86	30.02	23.29	3.46	33.47	23.40	3.51	35.73	25.50	3.54	38.03	27.57	3.59	40.29	27.47	3.61	42.58	29.26	3.65	
95	28.45	22.98	3.47	31.71	23.12	3.52	33.81	25.19	3.57	36.00	27.26	3.60	38.14	27.12	3.64	40.29	28.92	3.68	
104	21.10	17.29	2.70	23.51	17.39	2.73	25.10	18.93	2.76	26.69	20.46	2.79	28.30	20.39	2.81	29.91	21.74	2.85	
115	18.96	16.81	2.60	21.10	16.91	2.63	22.56	18.41	2.65	23.97	19.91	2.68	25.43	19.84	2.70	26.88	21.12	2.73	

AFR	m ³ /h	2,050
-----	-------------------	-------

		Indoor temperature																	
		17.8			21.1			23.9			26.7			29.4			32.2		
		12.2			15.6			17.2			19.4			21.7			22.8		
Outdoor temperature	°CDB	TC	SHC	IP	TC	SHC	IP	TC	SHC	IP	TC	SHC	IP	TC	SHC	IP	TC	SHC	IP
	°CWB	kW			kW			kW			kW			kW			kW		
		kW			kW			kW			kW			kW			kW		
	-20.6	8.97	7.43	0.59	10.01	7.46	0.60	9.98	7.11	0.78	10.61	7.69	0.78	11.24	7.66	0.79	11.89	8.16	0.80
	-15	8.19	6.49	1.27	9.14	6.52	1.28	9.76	7.11	1.30	10.38	7.69	1.31	11.00	7.66	1.32	11.63	8.15	1.34
	-10	8.06	6.34	1.56	8.98	6.38	1.59	9.58	6.95	1.61	10.20	7.51	1.63	10.82	7.48	1.64	11.43	7.97	1.65
	0	7.61	6.37	1.98	8.47	6.40	2.01	9.06	6.97	2.03	9.64	7.55	2.05	10.22	7.51	2.07	10.80	8.00	2.10
	5	7.60	6.27	2.01	8.47	6.31	2.04	9.04	6.87	2.06	9.62	7.43	2.07	10.19	7.40	2.10	10.77	7.89	2.12
	10	7.56	6.38	2.01	8.42	6.41	2.05	9.00	6.99	2.07	9.57	7.57	2.09	10.15	7.52	2.10	10.72	8.02	2.12
	15	8.13	6.53	2.21	9.06	6.57	2.24	9.67	7.16	2.26	10.29	7.74	2.29	10.91	7.71	2.32	11.53	8.21	2.34
19.4	9.14	6.87	2.63	10.18	6.91	2.67	10.87	7.52	2.70	11.57	8.14	2.72	12.27	8.11	2.75	12.95	8.64	2.77	
25	9.00	6.89	2.91	10.02	6.93	2.95	10.70	7.55	2.98	11.39	8.16	3.01	12.07	8.13	3.04	12.75	8.66	3.08	
30	8.80	6.83	3.46	9.81	6.86	3.51	10.47	7.47	3.54	11.14	8.08	3.59	11.81	8.05	3.61	12.48	8.58	3.65	
35	8.34	6.74	3.47	9.29	6.78	3.52	9.91	7.38	3.57	10.55	7.99	3.60	11.18	7.95	3.64	11.81	8.48	3.68	
40	6.18	5.07	2.70	6.89	5.10	2.73	7.36	5.55	2.76	7.82	6.00	2.79	8.29	5.98	2.81	8.77	6.37	2.85	
46.1	5.56	4.93	2.60	6.18	4.96	2.63	6.61	5.40	2.65	7.03	5.84	2.68	7.45	5.82	2.70	7.88	6.19	2.73	

Model: ARU42RGLX

DUCT TYPE
ARU12-48RGLXDUCT TYPE
ARU12-48RGLX

AFR	CFM	1,501
-----	-----	-------

		Indoor temperature																	
		64			70			75			80			85			90		
		54			60			63			67			71			73		
Outdoor temperature	°FDB	TC	SHC	IP	TC	SHC	IP	TC	SHC	IP	TC	SHC	IP	TC	SHC	IP	TC	SHC	IP
	°FWB	kBTu/h			kBTu/h			kBTu/h			kBTu/h			kBTu/h			kBTu/h		
		kW			kW			kW			kW			kW			kW		
	-5	32.16	27.57	1.10	35.83	27.71	1.11	38.26	30.19	1.12	40.70	32.63	1.13	43.15	32.52	1.15	45.61	34.63	1.16
	5	31.86	27.46	1.17	35.49	27.61	1.18	37.91	30.07	1.20	40.32	32.51	1.21	42.75	32.40	1.22	45.18	34.50	1.24
	14	31.53	27.36	1.21	35.13	27.53	1.22	37.53	29.97	1.24	39.93	32.40	1.24	42.33	32.29	1.26	44.73	34.39	1.27
	32	31.26	26.93	1.27	34.80	27.07	1.29	37.19	29.51	1.30	39.57	31.90	1.32	41.94	31.76	1.33	44.31	33.86	1.35
	41	30.84	26.86	1.35	34.35	27.04	1.37	36.69	29.43	1.39	39.03	31.83	1.40	41.37	31.69	1.41	43.71	33.79	1.42
	50	30.51	26.97	1.43	33.99	27.14	1.45	36.32	29.54	1.47	38.64	31.94	1.48	40.95	31.83	1.50	43.26	33.89	1.51
	59	30.30	27.21	1.55	33.78	27.39	1.57	36.08	29.83	1.59	38.37	32.26	1.61	40.68	32.12	1.62	42.99	34.21	1.64
67	31.14	26.50	1.79	34.68	26.68	1.81	37.07	29.04	1.83	39.42	31.41	1.85	41.79	31.30	1.87	44.16	33.33	1.88	
77	32.28	27.61	2.13	35.97	27.75	2.16	38.42	30.23	2.19	40.86	32.69	2.20	43.32	32.58	2.23	45.78	34.71	2.25	
86	33.90	27.82	3.20	37.77	27.96	3.25	40.35	30.47	3.28	42.93	32.93	3.31	45.51	32.83	3.34	48.06	34.96	3.38	
95	33.18	27.61	3.52	36.96	27.78	3.58	39.48	30.25	3.61	42.00	32.72	3.65	44.52	32.58	3.68	47.04	34.71	3.72	
104	30.48	26.04	3.63	33.96	26.22	3.68	36.27	28.55	3.72	38.58	30.87	3.75	40.89	30.73	3.79	43.20	32.76	3.83	
115	24.78	22.88	3.11	27.60	23.02	3.16	29.48	25.08	3.19	31.35	27.11	3.22	33.24	27.00	3.26	35.13	28.78	3.29	

AFR	m ³ /h	2,550
-----	-------------------	-------

		Indoor temperature																	
		17.8			21.1			23.9			26.7			29.4			32.2		
		12.2			15.6			17.2			19.4			21.7			22.8		
Outdoor temperature	°CDB	TC	SHC	IP	TC	SHC	IP	TC	SHC	IP	TC	SHC	IP	TC	SHC	IP	TC	SHC	IP
	°CWB	kW			kW			kW			kW			kW			kW		
		kW			kW			kW			kW			kW			kW		
	-20.6	9.43	8.08	1.10	10.50	8.12	1.11	11.21	8.85	1.12	11.93	9.56	1.13	12.65	9.53	1.15	13.37	10.15	1.16
	-15	9.34	8.05	1.17	10.40	8.09	1.18	11.11	8.81	1.20	11.82	9.53	1.21	12.53	9.50	1.22	13.24	10.11	1.24
	-10	9.24	8.02	1.21	10.30	8.07	1.22	11.00	8.78	1.24	11.70	9.50	1.24	12.41	9.47	1.26	13.11	10.08	1.27
	0	9.16	7.89	1.27	10.20	7.93	1.29	10.90	8.65	1.30	11.60	9.35	1.32	12.29	9.31	1.33	12.99	9.92	1.35
	5	9.04	7.87	1.35	10.07	7.92	1.37	10.75	8.63	1.39	11.44	9.33	1.40	12.13	9.29	1.41	12.81	9.90	1.42
	10	8.94	7.90	1.43	9.96	7.96	1.45	10.64	8.66	1.47	11.33	9.36	1.48	12.00	9.33	1.50	12.68	9.93	1.51
	15	8.88	7.98	1.55	9.90	8.03	1.57	10.57	8.74	1.59	11.25	9.45	1.61	11.92	9.41	1.62	12.60	10.03	1.64
19.4	9.13	7.77	1.79	10.16	7.82	1.81	10.86	8.51	1.83	11.55	9.20	1.85	12.25	9.17	1.87	12.94	9.77	1.88	
25	9.46	8.09	2.13	10.54	8.13	2.16	11.26	8.86	2.19	11.98	9.58	2.20	12.70	9.55	2.23	13.42	10.17	2.25	
30	9.94	8.15	3.20	11.07	8.19	3.25	11.83	8.93	3.28	12.58	9.65	3.31	13.34	9.62	3.34	14.09	10.25	3.38	
35	9.72	8.09	3.52	10.83	8.14	3.58	11.57	8.87	3.61	12.31	9.59	3.65	13.05	9.55	3.68	13.79	10.17	3.72	
40	8.93	7.63	3.63	9.95	7.68	3.68	10.63	8.37	3.72	11.31	9.05	3.75	11.98	9.01	3.79	12.66	9.60	3.83	
46.1	7.26	6.71	3.11	8.09	6.75	3.16	8.64	7.35	3.19	9.19	7.94	3.22	9.74	7.91	3.26	10.30	8.43	3.29	

Model: ARU48RGLX

DUCT TYPE
ARU12-48RGLXDUCT TYPE
ARU12-48RGLX

AFR	CFM	1,501
-----	-----	-------

		Indoor temperature																	
		64			70			75			80			85			90		
		54			60			63			67			71			73		
Outdoor temperature	°FDB	TC	SHC	IP	TC	SHC	IP	TC	SHC	IP	TC	SHC	IP	TC	SHC	IP	TC	SHC	IP
	°FWB	kBTu/h			kBTu/h			kBTu/h			kBTu/h			kBTu/h			kBTu/h		
		kW			kW			kW			kW			kW			kW		
	-5	35.72	29.99	1.77	39.81	30.16	1.80	42.52	32.86	1.82	45.23	35.53	1.83	47.94	35.40	1.85	50.66	37.72	1.87
	5	35.59	29.88	1.80	39.67	30.05	1.84	42.37	32.74	1.85	45.07	35.40	1.87	47.77	35.27	1.89	50.47	37.58	1.90
	14	35.23	28.13	1.89	39.25	28.30	1.93	41.93	30.79	1.95	44.59	33.32	1.96	47.29	33.19	1.99	49.96	35.37	2.01
	32	35.04	27.70	1.95	39.04	27.87	1.99	41.69	30.33	2.01	44.35	32.79	2.03	47.02	32.66	2.05	49.66	34.81	2.06
	41	34.74	27.77	2.00	38.71	27.93	2.03	41.33	30.41	2.05	43.96	32.89	2.07	46.60	32.76	2.09	49.24	34.91	2.12
	50	34.41	27.90	2.06	38.35	28.06	2.09	40.94	30.53	2.12	43.57	33.02	2.13	46.18	32.89	2.16	48.79	35.04	2.18
	59	34.47	27.87	2.15	38.41	28.03	2.18	41.03	30.53	2.21	43.66	33.02	2.23	46.27	32.89	2.25	48.88	35.04	2.27
67	35.71	28.00	2.52	39.79	28.16	2.56	42.49	30.66	2.58	45.19	33.19	2.61	47.92	33.06	2.63	50.62	35.20	2.66	
77	37.18	29.22	3.00	41.44	29.39	3.04	44.26	32.00	3.08	47.08	34.61	3.10	49.90	34.48	3.14	52.72	36.72	3.17	
86	38.32	29.39	4.19	42.70	29.55	4.26	45.59	32.18	4.30	48.52	34.81	4.34	51.43	34.68	4.38	54.34	36.96	4.43	
95	37.93	29.52	4.59	42.25	29.68	4.66	45.13	32.35	4.71	48.00	34.97	4.75	50.89	34.84	4.80	53.77	37.12	4.85	
104	34.86	27.87	4.71	38.83	28.03	4.78	41.47	30.53	4.83	44.11	33.02	4.88	46.78	32.89	4.93	49.42	35.04	4.98	
115	26.64	23.70	3.58	29.67	23.83	3.64	31.71	25.97	3.67	33.72	28.06	3.70	35.77	27.97	3.75	37.78	29.78	3.78	

AFR	m ³ /h	2,550
-----	-------------------	-------

		Indoor temperature																	
		17.8			21.1			23.9			26.7			29.4			32.2		
		12.2			15.6			17.2			19.4			21.7			22.8		
Outdoor temperature	°CDB	TC	SHC	IP	TC	SHC	IP	TC	SHC	IP	TC	SHC	IP	TC	SHC	IP	TC	SHC	IP
	°CWB	kW			kW			kW			kW			kW			kW		
		kW			kW			kW			kW			kW			kW		
	-20.6	10.47	8.79	1.77	11.67	8.84	1.80	12.46	9.63	1.82	13.26	10.41	1.83	14.05	10.38	1.85	14.85	11.06	1.87
	-15	10.43	8.76	1.80	11.63	8.81	1.84	12.42	9.60	1.85	13.21	10.38	1.87	14.00	10.34	1.89	14.79	11.02	1.90
	-10	10.32	8.24	1.89	11.50	8.29	1.93	12.29	9.02	1.95	13.07	9.77	1.96	13.86	9.73	1.99	14.64	10.37	2.01
	0	10.27	8.12	1.95	11.44	8.17	1.99	12.22	8.89	2.01	13.00	9.61	2.03	13.78	9.57	2.05	14.55	10.20	2.06
	5	10.18	8.14	2.00	11.34	8.19	2.03	12.11	8.91	2.05	12.88	9.64	2.07	13.66	9.60	2.09	14.43	10.23	2.12
	10	10.09	8.18	2.06	11.24	8.23	2.09	12.00	8.95	2.12	12.77	9.68	2.13	13.53	9.64	2.16	14.30	10.27	2.18
	15	10.10	8.17	2.15	11.26	8.22	2.18	12.03	8.95	2.21	12.79	9.68	2.23	13.56	9.64	2.25	14.33	10.27	2.27
19.4	10.46	8.21	2.52	11.66	8.25	2.56	12.45	8.99	2.58	13.24	9.73	2.61	14.04	9.69	2.63	14.84	10.32	2.66	
25	10.90	8.56	3.00	12.14	8.61	3.04	12.97	9.38	3.08	13.80	10.14	3.10	14.62	10.10	3.14	15.45	10.76	3.17	
30	11.23	8.61	4.19	12.51	8.66	4.26	13.36	9.43	4.30	14.22	10.20	4.34	15.07	10.16	4.38	15.93	10.83	4.43	
35	11.12	8.65	4.59	12.38	8.70	4.66	13.23	9.48	4.71	14.07	10.25	4.75	14.91	10.21	4.80	15.76	10.88	4.85	
40	10.22	8.17	4.71	11.38	8.22	4.78	12.15	8.95	4.83	12.93	9.68	4.88	13.71	9.64	4.93	14.48	10.27	4.98	
46.1	7.81	6.95	3.58	8.70	6.99	3.64	9.29	7.61	3.67	9.88	8.23	3.70	10.48	8.20	3.75	11.07	8.73	3.78	

4-2. Heating capacity

NOTE: Values mentioned in the table are calculated based on the maximum capacity.

■ Model: ARU12RGLX

AFR		CFM		500							
		Indoor temperature									
Outdoor temperature	°FDB	°FDB	60		65		70		75		
			TC	IP	TC	IP	TC	IP	TC	IP	
			kBtu/h	kW	kBtu/h	kW	kBtu/h	kW	kBtu/h	kW	
-5	-7	15.76	2.05	15.38	2.09	15.01	2.13	14.26	2.17		
5	3	17.56	1.98	17.12	2.03	16.71	2.07	15.86	2.15		
14	12	18.24	1.92	17.80	1.96	17.36	1.99	16.51	2.08		
17	21	18.57	1.90	18.12	1.94	17.69	1.97	16.80	2.06		
23	19	19.09	1.85	18.65	1.88	18.21	1.93	17.29	2.00		
32	28	19.40	1.79	18.96	1.83	18.48	1.86	17.56	1.94		
41	37	19.67	1.71	19.20	1.75	18.72	1.78	17.80	1.86		
47	43	20.39	1.76	19.88	1.80	19.40	1.84	18.45	1.91		
50	47	22.46	1.78	21.92	1.82	21.37	1.86	20.32	1.93		
59	50	23.28	1.79	22.70	1.83	22.16	1.86	21.07	1.94		

AFR		m ³ /h		850							
		Indoor temperature									
Outdoor temperature	°CDB	°CDB	15.6		18.3		21.1		23.9		
			TC	IP	TC	IP	TC	IP	TC	IP	
			kW		kW		kW		kW		
-20.6	-21.7	4.62	2.05	4.51	2.09	4.40	2.13	4.18	2.17		
-15	-16.1	5.15	1.98	5.02	2.03	4.90	2.07	4.65	2.15		
-10	-11.1	5.35	1.92	5.22	1.96	5.09	1.99	4.84	2.08		
-8.3	-6.1	5.44	1.90	5.31	1.94	5.18	1.97	4.92	2.06		
-5	-7.2	5.60	1.85	5.47	1.88	5.34	1.93	5.07	2.00		
0	-2.2	5.69	1.79	5.56	1.83	5.42	1.86	5.15	1.94		
5	2.8	5.77	1.71	5.63	1.75	5.49	1.78	5.22	1.86		
8.3	6.1	5.98	1.76	5.83	1.80	5.69	1.84	5.41	1.91		
10	8.3	6.58	1.78	6.42	1.82	6.26	1.86	5.96	1.93		
15	10	6.82	1.79	6.65	1.83	6.49	1.86	6.17	1.94		

■ Model: ARU18RGLX

AFR		CFM		618									
		Indoor temperature											
Outdoor temperature	°FDB	°FDB	60		65		70		72		75		
			TC	IP	TC	IP	TC	IP	TC	IP	TC	IP	
			kBtu/h	kW	kBtu/h	kW	kBtu/h	kW	kBtu/h	kW	kBtu/h	kW	
-5	-7	16.36	2.03	15.98	2.07	15.59	2.12	15.19	2.16	14.82	2.20		
5	3	18.88	2.06	18.45	2.10	17.99	2.15	17.53	2.19	17.10	2.23		
14	12	20.00	2.07	19.52	2.11	19.04	2.16	18.56	2.20	18.08	2.24		
17	21	20.83	2.08	20.33	2.12	19.83	2.17	19.33	2.21	18.83	2.25		
23	19	21.85	2.11	21.35	2.15	20.82	2.19	20.30	2.24	19.77	2.28		
32	28	23.20	2.11	22.65	2.15	22.08	2.19	21.53	2.24	20.98	2.28		
41	37	25.76	2.11	25.17	2.16	24.55	2.21	23.93	2.25	23.31	2.30		
47	43	26.88	2.11	26.24	2.15	25.60	2.19	24.96	2.24	24.32	2.28		
50	47	27.79	2.07	27.13	2.11	26.47	2.15	25.81	2.20	25.14	2.24		
59	50	24.82	1.59	24.23	1.62	23.63	1.65	23.04	1.69	22.45	1.71		

AFR		m ³ /h		1,050									
		Indoor temperature											
Outdoor temperature	°CDB	°CDB	15.6		18.3		21.1		22.2		23.9		
			TC	IP	TC	IP	TC	IP	TC	IP	TC	IP	
			kW		kW		kW		kW		kW		
-20.6	-21.7	4.80	2.03	4.68	2.07	4.57	2.12	4.45	2.16	4.34	2.20		
-15	-16.1	5.53	2.06	5.41	2.10	5.27	2.15	5.14	2.19	5.01	2.23		
-10	-11.1	5.86	2.07	5.72	2.11	5.58	2.16	5.44	2.20	5.30	2.24		
-8.3	-6.1	6.11	2.08	5.96	2.12	5.81	2.17	5.67	2.21	5.52	2.25		
-5	-7.2	6.40	2.11	6.26	2.15	6.10	2.19	5.95	2.24	5.79	2.28		
0	-2.2	6.80	2.11	6.64	2.15	6.47	2.19	6.31	2.24	6.15	2.28		
5	2.8	7.55	2.11	7.38	2.16	7.19	2.21	7.01	2.25	6.83	2.30		
8.3	6.1	7.88	2.11	7.69	2.15	7.50	2.19	7.32	2.24	7.13	2.28		
10	8.3	8.15	2.07	7.95	2.11	7.76	2.15	7.56	2.20	7.37	2.24		
15	10	7.28	1.59	7.10	1.62	6.93	1.65	6.75	1.69	6.58	1.71		

Model: ARU24RGLX

AFR	CFM	800
-----	-----	-----

Outdoor temperature		°FDB	°FWB	Indoor temperature									
				60		65		70		72		75	
				TC	IP	TC	IP	TC	IP	TC	IP	TC	IP
				kBtu/h	kW	kBtu/h	kW	kBtu/h	kW	kBtu/h	kW	kBtu/h	kW
-5	-7	20.24	3.21	19.75	3.27	19.27	3.39	18.78	3.40	18.29	3.48	17.80	3.56
5	3	23.34	3.24	22.78	3.31	22.22	3.38	21.66	3.44	21.10	3.52	20.54	3.59
14	12	25.21	3.27	24.62	3.33	24.01	3.40	23.42	3.47	22.81	3.53	22.22	3.60
17	21	26.11	3.26	25.50	3.32	24.87	3.39	24.26	3.46	23.62	3.52	23.02	3.59
23	19	26.94	3.25	26.30	3.31	25.66	3.38	25.00	3.45	24.36	3.52	23.76	3.59
32	28	30.08	3.22	29.36	3.29	28.65	3.36	27.94	3.42	27.22	3.49	26.50	3.56
41	37	32.94	3.17	32.14	3.24	31.35	3.31	30.56	3.37	29.80	3.44	29.01	3.51
47	43	34.03	2.83	33.22	2.89	32.40	2.96	31.58	3.01	30.79	3.07	29.98	3.14
50	47	34.82	2.73	33.98	2.79	33.17	2.84	32.32	2.89	31.51	2.96	30.74	3.03
59	50	30.95	2.09	30.21	2.14	29.47	2.18	28.73	2.22	28.01	2.25	27.27	2.29

AFR	m³/h	1,360
-----	------	-------

Outdoor temperature		°CDB	°CWB	Indoor temperature									
				15.6		18.3		21.1		22.2		23.9	
				TC	IP	TC	IP	TC	IP	TC	IP	TC	IP
				kW		kW		kW		kW		kW	
-20.6	-21.7	5.93	3.21	5.79	3.27	5.65	3.39	5.50	3.40	5.36	3.48	5.22	3.56
-15	-16.1	6.84	3.24	6.68	3.31	6.51	3.38	6.35	3.44	6.18	3.52	6.01	3.59
-10	-11.1	7.39	3.27	7.22	3.33	7.04	3.40	6.86	3.47	6.68	3.53	6.50	3.60
-8.3	-6.1	7.65	3.26	7.47	3.32	7.29	3.39	7.11	3.46	6.92	3.52	6.74	3.59
-5	-7.2	7.90	3.25	7.71	3.31	7.52	3.38	7.33	3.45	7.14	3.52	6.96	3.59
0	-2.2	8.82	3.22	8.61	3.29	8.40	3.36	8.19	3.42	7.98	3.49	7.77	3.56
5	2.8	9.65	3.17	9.42	3.24	9.19	3.31	8.96	3.37	8.73	3.44	8.50	3.51
8.3	6.1	9.97	2.83	9.74	2.89	9.50	2.96	9.26	3.01	9.02	3.07	8.78	3.14
10	8.3	10.21	2.73	9.96	2.79	9.72	2.84	9.47	2.89	9.23	2.96	8.98	3.03
15	10	9.07	2.09	8.85	2.14	8.64	2.18	8.42	2.22	8.21	2.25	8.00	2.29

Model: ARU30RGLX

AFR	CFM	1,001
-----	-----	-------

Outdoor temperature		°FDB	°FWB	Indoor temperature									
				60		65		70		72		75	
				TC	IP	TC	IP	TC	IP	TC	IP	TC	IP
				kBtu/h	kW	kBtu/h	kW	kBtu/h	kW	kBtu/h	kW	kBtu/h	kW
-5	-7	25.20	3.15	24.60	3.22	23.99	3.28	23.42	3.35	22.81	3.41	22.22	3.48
5	3	29.04	3.18	28.34	3.24	27.65	3.31	26.99	3.37	26.29	3.44	25.60	3.51
14	12	30.61	3.19	29.88	3.25	29.15	3.32	28.41	3.38	27.68	3.45	27.09	3.52
17	21	31.65	3.20	30.89	3.26	30.14	3.33	29.38	3.40	28.62	3.46	27.96	3.53
23	19	33.25	3.21	32.45	3.28	31.65	3.35	30.85	3.41	30.09	3.48	29.32	3.54
32	28	35.24	3.18	34.40	3.24	33.57	3.31	32.73	3.37	31.90	3.44	31.07	3.51
41	37	39.10	3.16	38.16	3.22	37.22	3.29	36.32	3.35	35.38	3.41	34.54	3.48
47	43	40.95	3.14	39.98	3.20	39.00	3.27	38.03	3.34	37.05	3.40	36.11	3.47
50	47	42.20	3.11	41.19	3.18	40.18	3.24	39.17	3.31	38.16	3.36	37.14	3.44
59	50	37.82	2.37	36.91	2.42	36.01	2.47	35.13	2.52	34.23	2.55	33.36	2.60

AFR	m³/h	1,700
-----	------	-------

Outdoor temperature		°CDB	°CWB	Indoor temperature									
				15.6		18.3		21.1		22.2		23.9	
				TC	IP	TC	IP	TC	IP	TC	IP	TC	IP
				kW		kW		kW		kW		kW	
-20.6	-21.7	7.39	3.15	7.21	3.22	7.03	3.28	6.86	3.35	6.69	3.41	6.52	3.48
-15	-16.1	8.51	3.18	8.31	3.24	8.10	3.31	7.91	3.37	7.71	3.44	7.52	3.51
-10	-11.1	8.97	3.19	8.76	3.25	8.54	3.32	8.33	3.38	8.11	3.45	7.90	3.52
-8.3	-6.1	9.28	3.20	9.05	3.26	8.83	3.33	8.61	3.40	8.39	3.46	8.17	3.53
-5	-7.2	9.75	3.21	9.51	3.28	9.28	3.35	9.04	3.41	8.82	3.48	8.59	3.54
0	-2.2	10.33	3.18	10.08	3.24	9.84	3.31	9.59	3.37	9.35	3.44	9.10	3.51
5	2.8	11.46	3.16	11.19	3.22	10.91	3.29	10.64	3.35	10.37	3.41	10.10	3.48
8.3	6.1	12.00	3.14	11.72	3.20	11.43	3.27	11.14	3.34	10.86	3.40	10.57	3.47
10	8.3	12.37	3.11	12.07	3.18	11.78	3.24	11.48	3.31	11.19	3.36	10.88	3.44
15	10	11.08	2.37	10.82	2.42	10.55	2.47	10.30	2.52	10.03	2.55	9.76	2.60

Model: ARU36RGLX

AFR	CFM	1,089
-----	-----	-------

Outdoor temperature		Indoor temperature											
		°FDB		60		65		70		72		75	
		°FDB	°FWB	TC	IP	TC	IP	TC	IP	TC	IP	TC	IP
	-5	-7	31.14	4.54	30.39	4.63	29.64	4.76	28.90	4.81	28.15	4.92	
	5	3	34.58	4.80	33.75	4.91	32.92	5.01	32.09	5.10	31.26	5.21	
	14	12	37.34	4.84	36.47	4.93	35.57	5.03	34.70	5.13	33.79	5.23	
	17	21	38.68	4.82	37.78	4.91	36.84	5.01	35.94	5.12	35.00	5.22	
	23	19	39.91	4.81	38.97	4.91	38.02	5.01	37.04	5.11	36.09	5.21	
	32	28	44.56	4.77	43.50	4.87	42.44	4.97	41.39	5.06	40.33	5.16	
	41	37	48.79	4.69	47.62	4.80	46.45	4.89	45.28	5.00	44.14	5.09	
	47	43	50.42	4.19	49.21	4.27	48.00	4.38	46.79	4.45	45.62	4.54	
	50	47	51.59	4.05	50.34	4.13	49.13	4.21	47.89	4.28	46.68	4.39	
	59	50	45.85	3.09	44.75	3.17	43.65	3.22	42.56	3.29	41.50	3.34	

AFR	m ³ /h	1,850
-----	-------------------	-------

Outdoor temperature		Indoor temperature											
		°CDB		15.6		18.3		21.1		22.2		23.9	
		°CDB	°CWB	TC	IP	TC	IP	TC	IP	TC	IP	TC	IP
	-20.6	-21.7	9.13	4.54	8.91	4.63	8.69	4.76	8.47	4.81	8.25	4.92	
	-15	-16.1	10.14	4.80	9.89	4.91	9.65	5.01	9.40	5.10	9.16	5.21	
	-10	-11.1	10.94	4.84	10.69	4.93	10.42	5.03	10.17	5.13	9.90	5.23	
	-8.3	-6.1	11.34	4.82	11.07	4.91	10.80	5.01	10.53	5.12	10.26	5.22	
	-5	-7.2	11.70	4.81	11.42	4.91	11.14	5.01	10.86	5.11	10.58	5.21	
	0	-2.2	13.06	4.77	12.75	4.87	12.44	4.97	12.13	5.06	11.82	5.16	
	5	2.8	14.30	4.69	13.96	4.80	13.61	4.89	13.27	5.00	12.94	5.09	
	8.3	6.1	14.78	4.19	14.42	4.27	14.07	4.38	13.71	4.45	13.37	4.54	
	10	8.3	15.12	4.05	14.75	4.13	14.40	4.21	14.03	4.28	13.68	4.39	
	15	10	13.44	3.09	13.12	3.17	12.79	3.22	12.47	3.29	12.16	3.34	

Model: ARU42RGLX

AFR	CFM	1,501
-----	-----	-------

Outdoor temperature		Indoor temperature											
		°FDB		60		65		70		72		75	
		°FDB	°FWB	TC	IP	TC	IP	TC	IP	TC	IP	TC	IP
	-5	-7	34.90	4.38	34.05	4.47	33.24	4.57	32.40	4.65	31.58	4.75	
	5	3	37.82	4.39	36.90	4.47	36.02	4.57	35.11	4.66	34.23	4.75	
	14	12	42.38	4.39	41.37	4.47	40.37	4.56	39.36	4.66	38.35	4.74	
	17	21	43.23	4.39	42.20	4.47	41.17	4.56	40.14	4.66	39.12	4.74	
	23	19	45.56	4.38	44.49	4.47	43.39	4.56	42.32	4.65	41.25	4.74	
	32	28	48.90	4.38	47.73	4.47	46.57	4.56	45.40	4.65	44.24	4.74	
	41	37	52.05	4.39	50.82	4.47	49.56	4.56	48.33	4.66	47.10	4.74	
	47	43	53.56	4.39	52.30	4.47	51.00	4.57	49.75	4.66	48.46	4.74	
	50	47	54.85	4.37	53.53	4.46	52.24	4.55	50.91	4.64	49.62	4.74	
	59	50	55.92	4.34	54.60	4.44	53.24	4.53	51.92	4.61	50.60	4.68	

AFR	m ³ /h	2,550
-----	-------------------	-------

Outdoor temperature		Indoor temperature											
		°CDB		15.6		18.3		21.1		22.2		23.9	
		°CDB	°CWB	TC	IP	TC	IP	TC	IP	TC	IP	TC	IP
	-20.6	-21.7	10.23	4.38	9.98	4.47	9.74	4.57	9.50	4.65	9.26	4.75	
	-15	-16.1	11.08	4.39	10.82	4.47	10.56	4.57	10.29	4.66	10.03	4.75	
	-10	-11.1	12.42	4.39	12.13	4.47	11.83	4.56	11.54	4.66	11.24	4.74	
	-8.3	-6.1	12.67	4.39	12.37	4.47	12.07	4.56	11.77	4.66	11.46	4.74	
	-5	-7.2	13.35	4.38	13.04	4.47	12.72	4.56	12.40	4.65	12.09	4.74	
	0	-2.2	14.33	4.38	13.99	4.47	13.65	4.56	13.31	4.65	12.97	4.74	
	5	2.8	15.25	4.39	14.89	4.47	14.53	4.56	14.17	4.66	13.81	4.74	
	8.3	6.1	15.70	4.39	15.33	4.47	14.95	4.57	14.58	4.66	14.20	4.74	
	10	8.3	16.08	4.37	15.69	4.46	15.31	4.55	14.92	4.64	14.54	4.74	
	15	10	16.39	4.34	16.00	4.44	15.61	4.53	15.22	4.61	14.83	4.68	

■ Model: ARU48RGLX

DUCT TYPE
ARU12-48RGLX

DUCT TYPE
ARU12-48RGLX

AFR	CFM	1,501
-----	-----	-------

Outdoor temperature		°FDB	°FWB	Indoor temperature									
				60		65		70		72		75	
				TC	IP	TC	IP	TC	IP	TC	IP	TC	IP
	°FDB			kBtu/h	kW	kBtu/h	kW	kBtu/h	kW	kBtu/h	kW	kBtu/h	kW
	-5	-7		35.10	4.57	34.25	4.66	33.43	4.76	32.58	4.85	31.76	4.95
	5	3		37.89	4.57	36.97	4.66	36.09	4.76	35.17	4.85	34.28	4.95
	14	12		42.84	4.57	41.83	4.66	40.82	4.76	39.78	4.86	38.78	4.95
	17	21		44.68	4.57	43.63	4.66	42.58	4.76	41.50	4.86	40.44	4.95
	23	19		48.22	4.57	47.06	4.66	45.90	4.76	44.77	4.85	43.60	4.95
	32	28		51.85	4.57	50.63	4.66	49.41	4.76	48.16	4.86	46.93	4.95
	41	37		55.98	4.58	54.63	4.67	53.29	4.77	51.98	4.87	50.63	4.97
	47	43		57.75	4.58	56.38	4.68	55.00	4.77	53.63	4.87	52.25	4.97
	50	47		59.22	4.57	57.81	4.66	56.41	4.75	54.97	4.85	53.57	4.95
	59	50		60.62	4.53	59.16	4.62	57.72	4.71	56.28	4.81	54.85	4.88

AFR	m ³ /h	2,550
-----	-------------------	-------

Outdoor temperature		°CDB	°CWB	Indoor temperature									
				15.6		18.3		21.1		22.2		23.9	
				TC	IP	TC	IP	TC	IP	TC	IP	TC	IP
	°CDB			kW		kW		kW		kW		kW	
	-20.6	-21.7		10.29	4.57	10.04	4.66	9.80	4.76	9.55	4.85	9.31	4.95
	-15	-16.1		11.10	4.57	10.84	4.66	10.58	4.76	10.31	4.85	10.05	4.95
	-10	-11.1		12.56	4.57	12.26	4.66	11.96	4.76	11.66	4.86	11.36	4.95
	-8.3	-6.1		13.10	4.57	12.79	4.66	12.48	4.76	12.16	4.86	11.85	4.95
	-5	-7.2		14.13	4.57	13.79	4.66	13.45	4.76	13.12	4.85	12.78	4.95
	0	-2.2		15.20	4.57	14.84	4.66	14.48	4.76	14.11	4.86	13.76	4.95
	5	2.8		16.41	4.58	16.01	4.67	15.62	4.77	15.23	4.87	14.84	4.97
	8.3	6.1		16.93	4.58	16.52	4.68	16.12	4.77	15.72	4.87	15.31	4.97
	10	8.3		17.36	4.57	16.94	4.66	16.53	4.75	16.11	4.85	15.70	4.95
	15	10		17.77	4.53	17.34	4.62	16.92	4.71	16.50	4.81	16.08	4.88

5. Fan performance

5-1. Fan performance curve

■ Model: ARU12RGLX

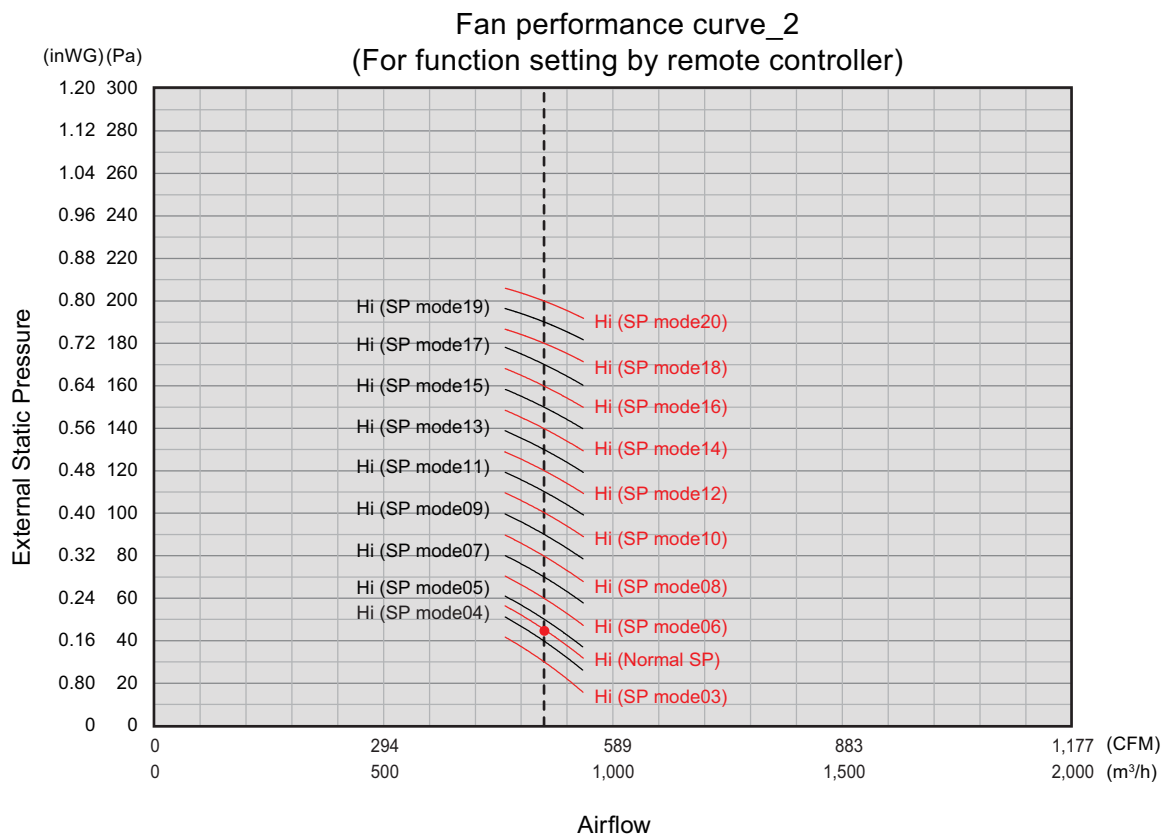
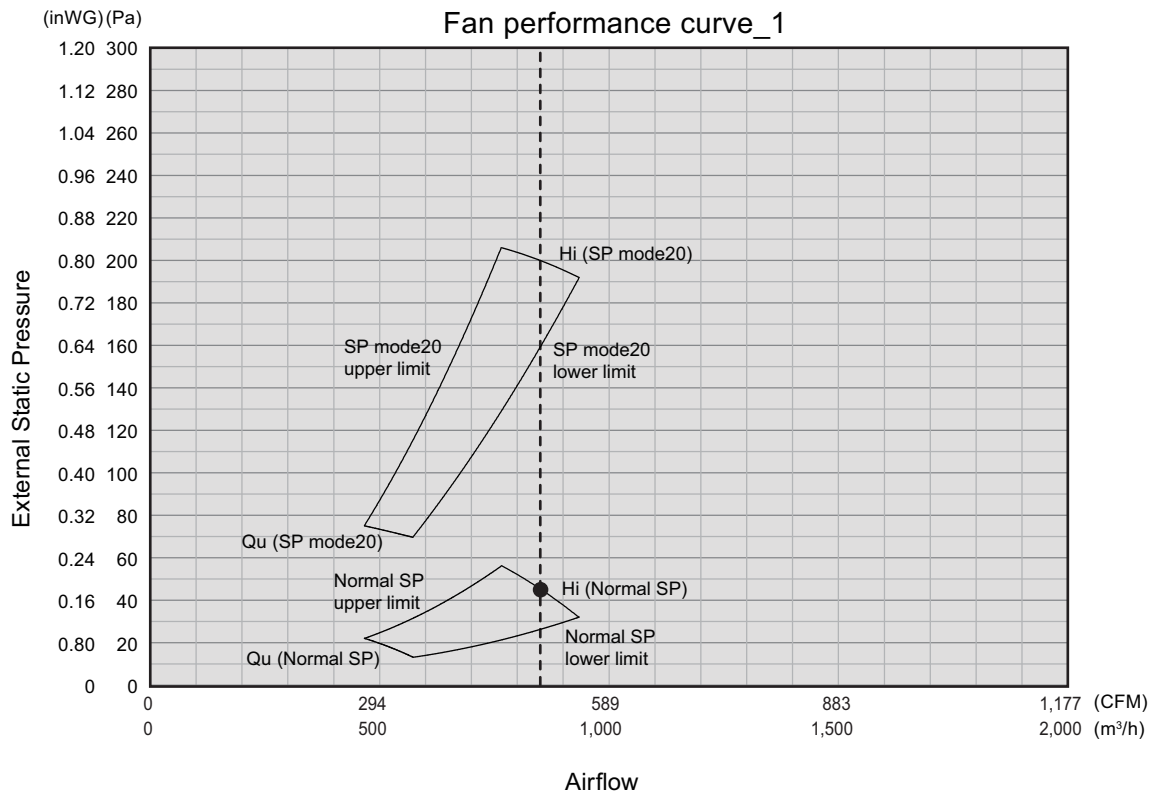

NOTES:

- Setting of the external static pressure is switchable into modes by using the remote controller.
- According to the resistance of the connecting duct, perform the setting of the external static pressure with referring "Fan performance curve_2" above.
- The default setting is set at "Normal SP".

● Characteristics of air volume and capacity

• Cooling

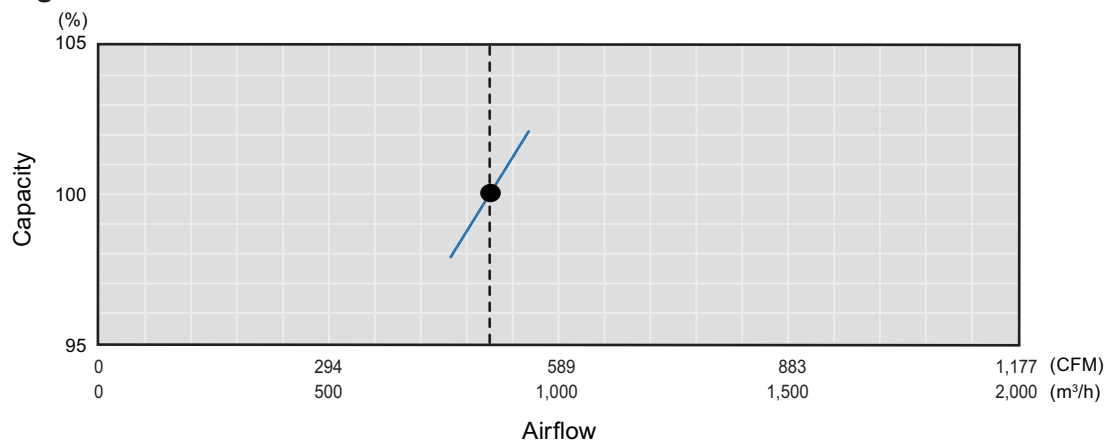

• Heating

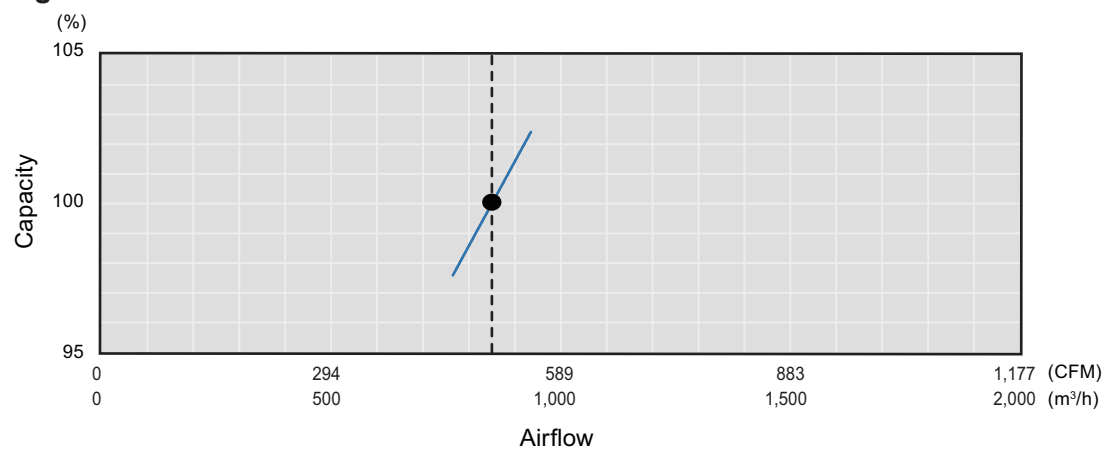

Model: ARU18RGLX

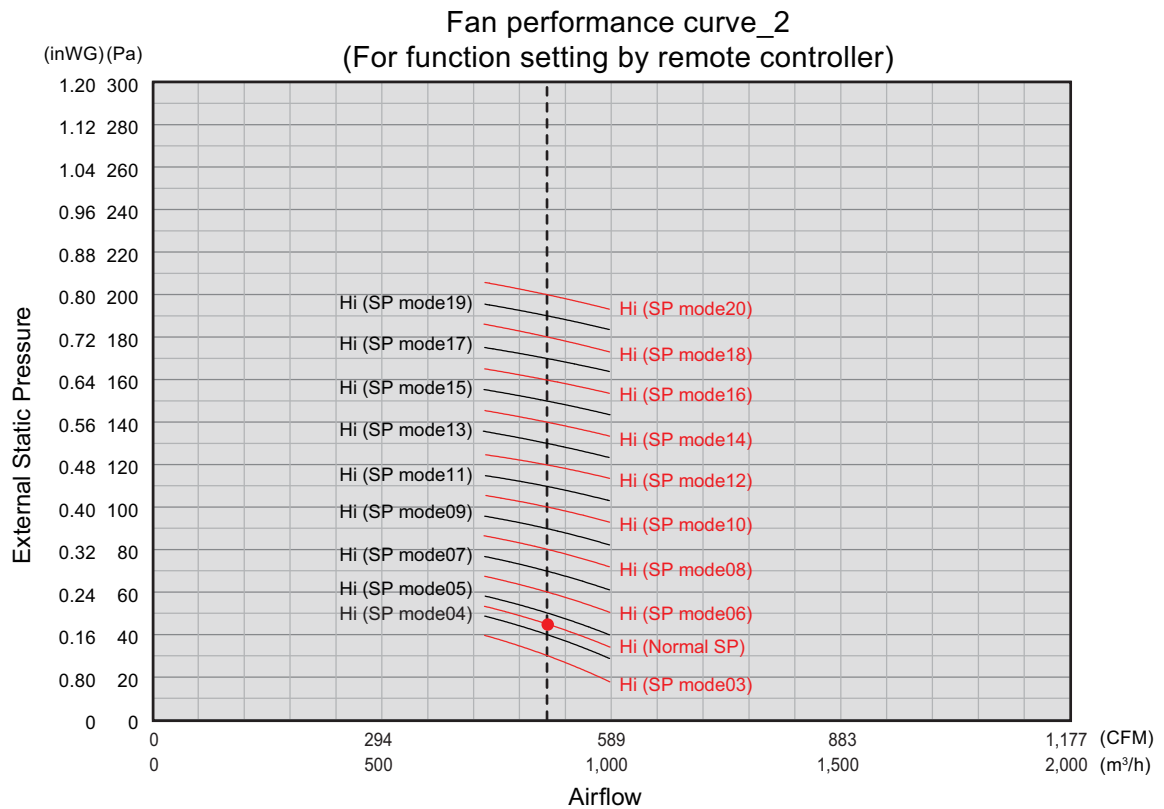
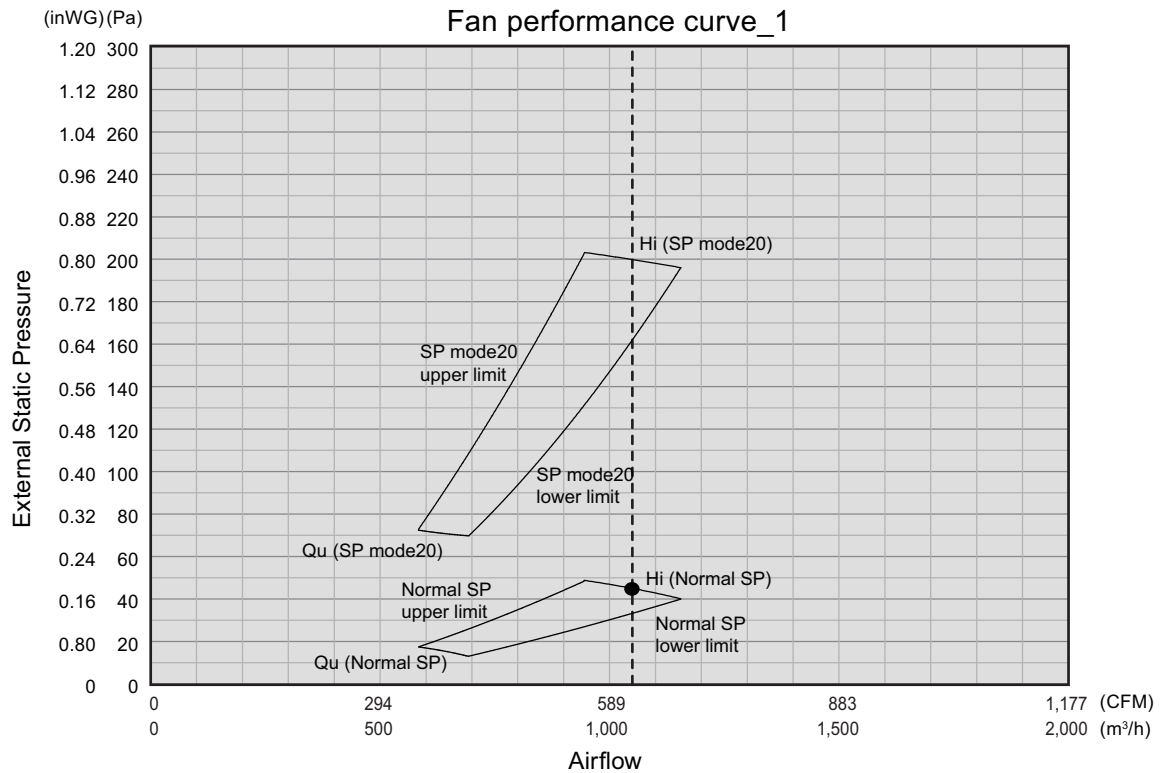

NOTES:

- Setting of the external static pressure is switchable into modes by using the remote controller.
- According to the resistance of the connecting duct, perform the setting of the external static pressure with referring "Fan performance curve_2" above.
- The default setting is set at "Normal SP".

● Characteristics of air volume and capacity

• Cooling

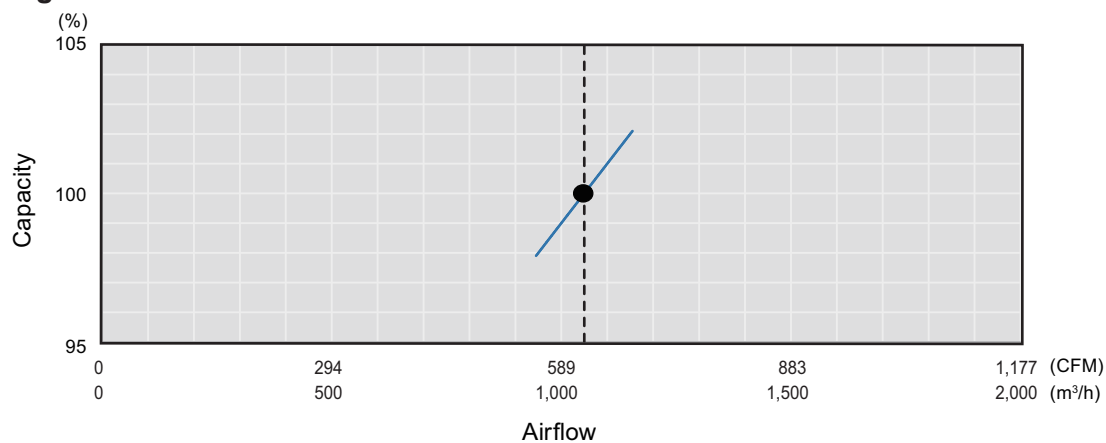

• Heating

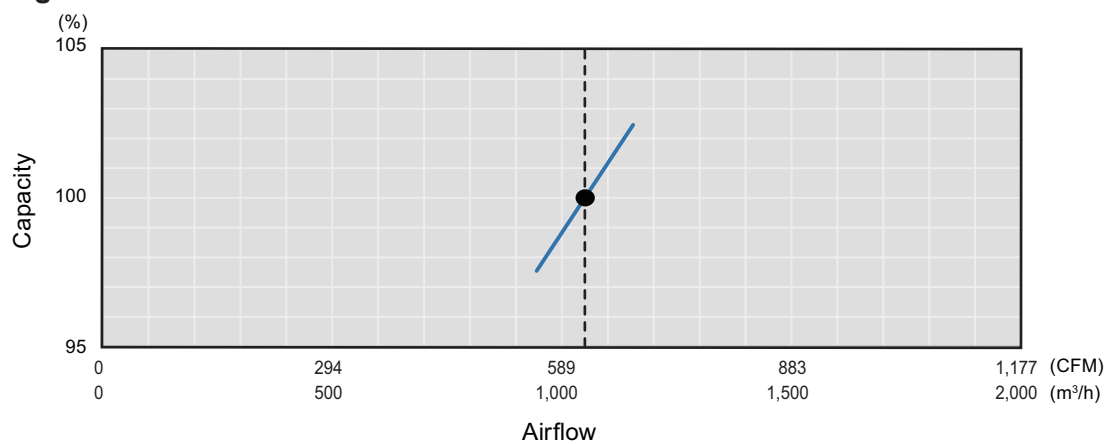

Model: ARU24RGLX

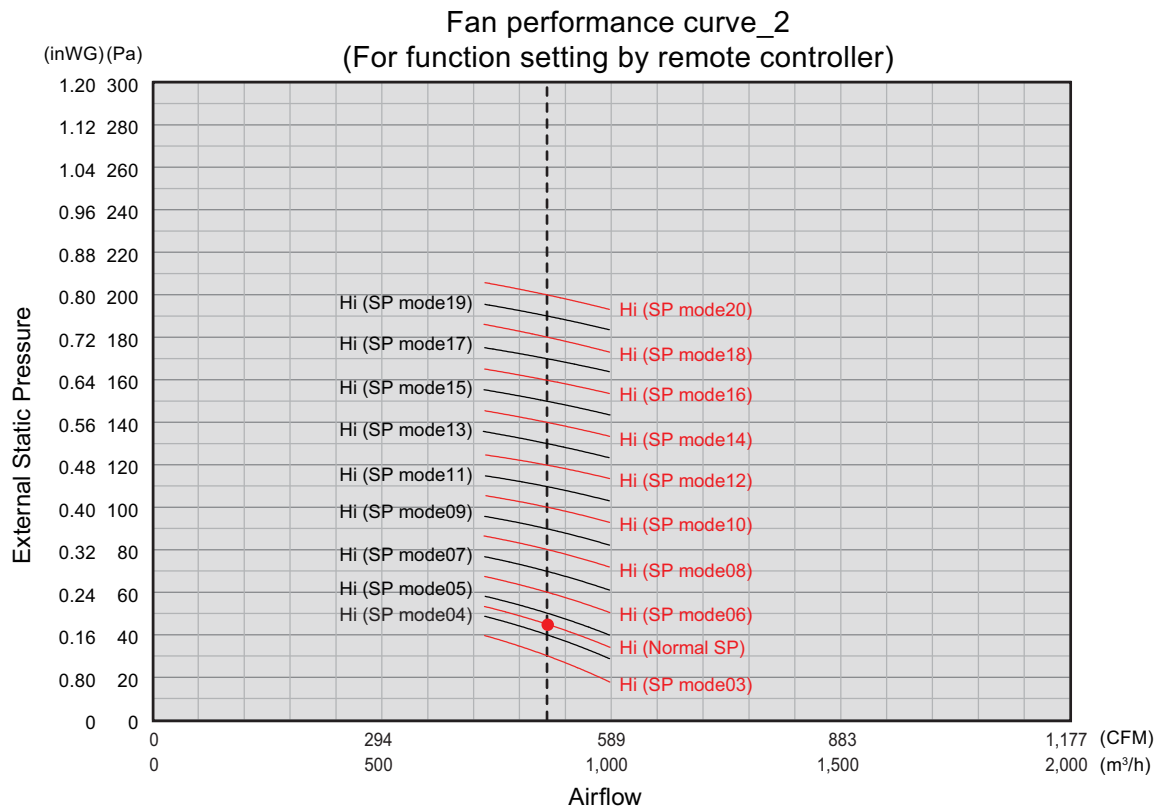
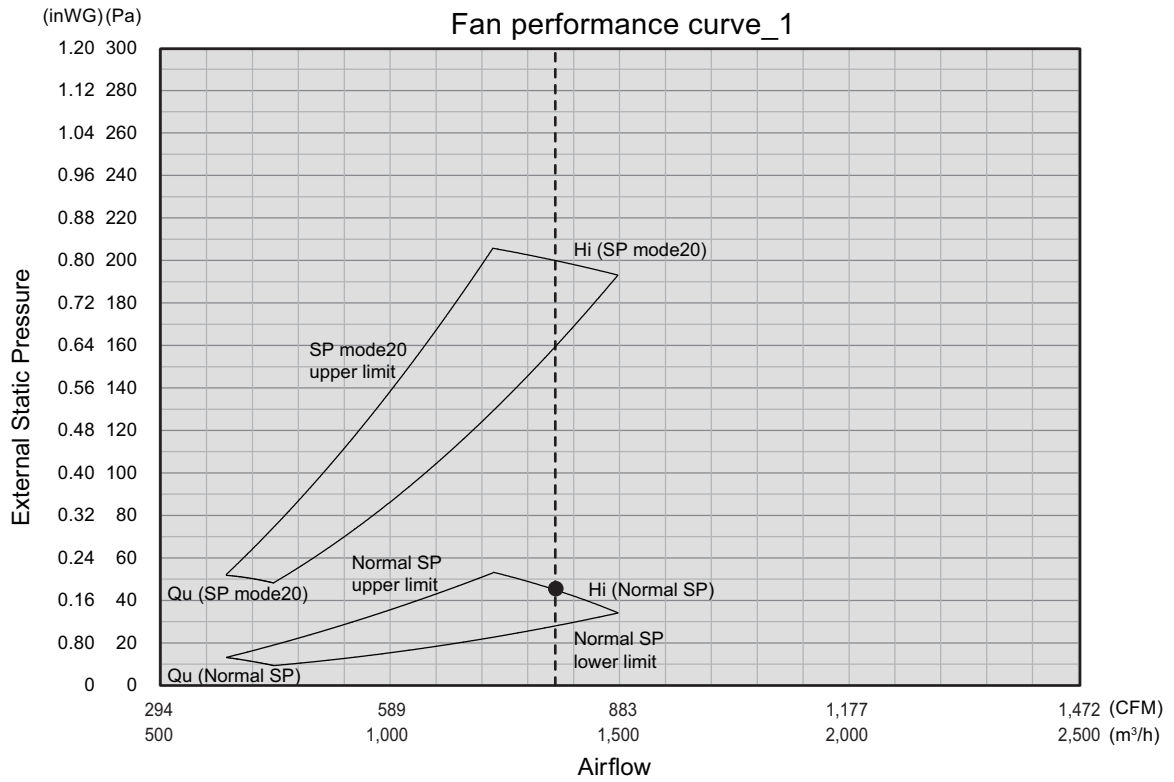

NOTES:

- Setting of the external static pressure is switchable into modes by using the remote controller.
- According to the resistance of the connecting duct, perform the setting of the external static pressure with referring "Fan performance curve_2" above.
- The default setting is set at "Normal SP".

● Characteristics of air volume and capacity

• Cooling

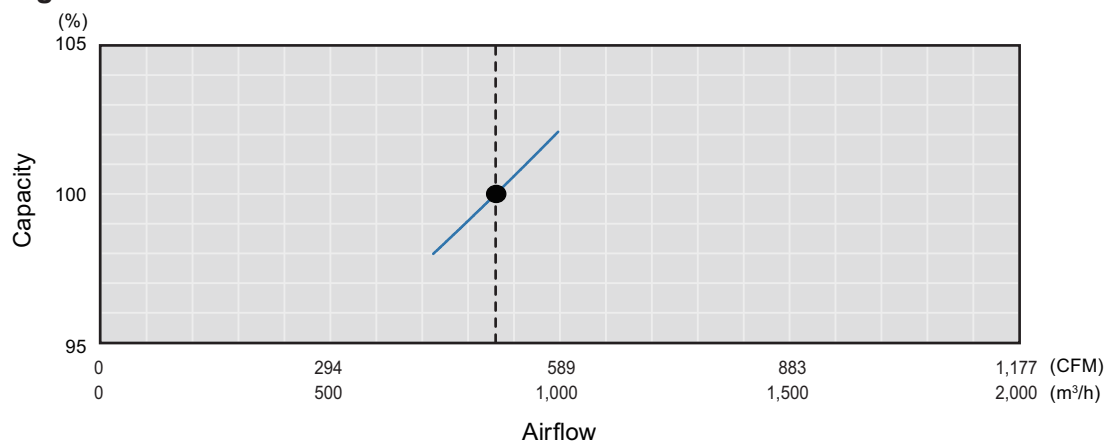

• Heating

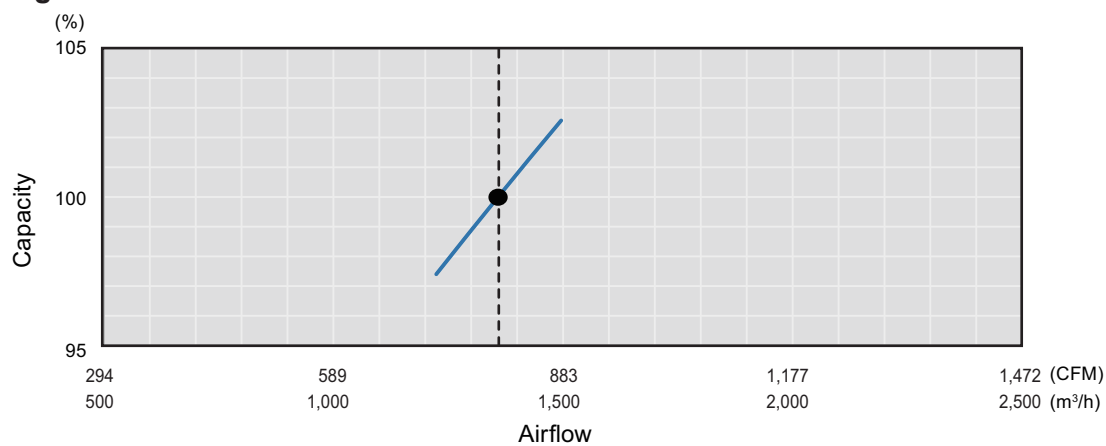

Model: ARU30RGLX

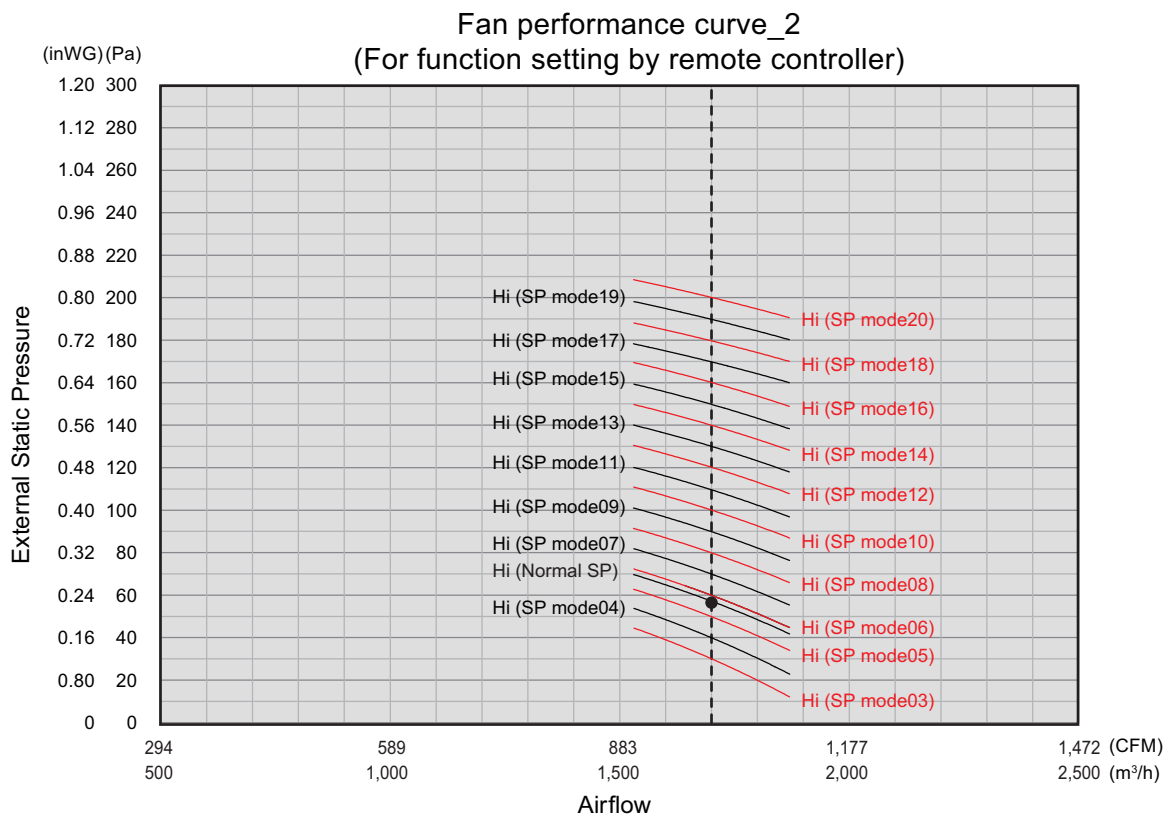
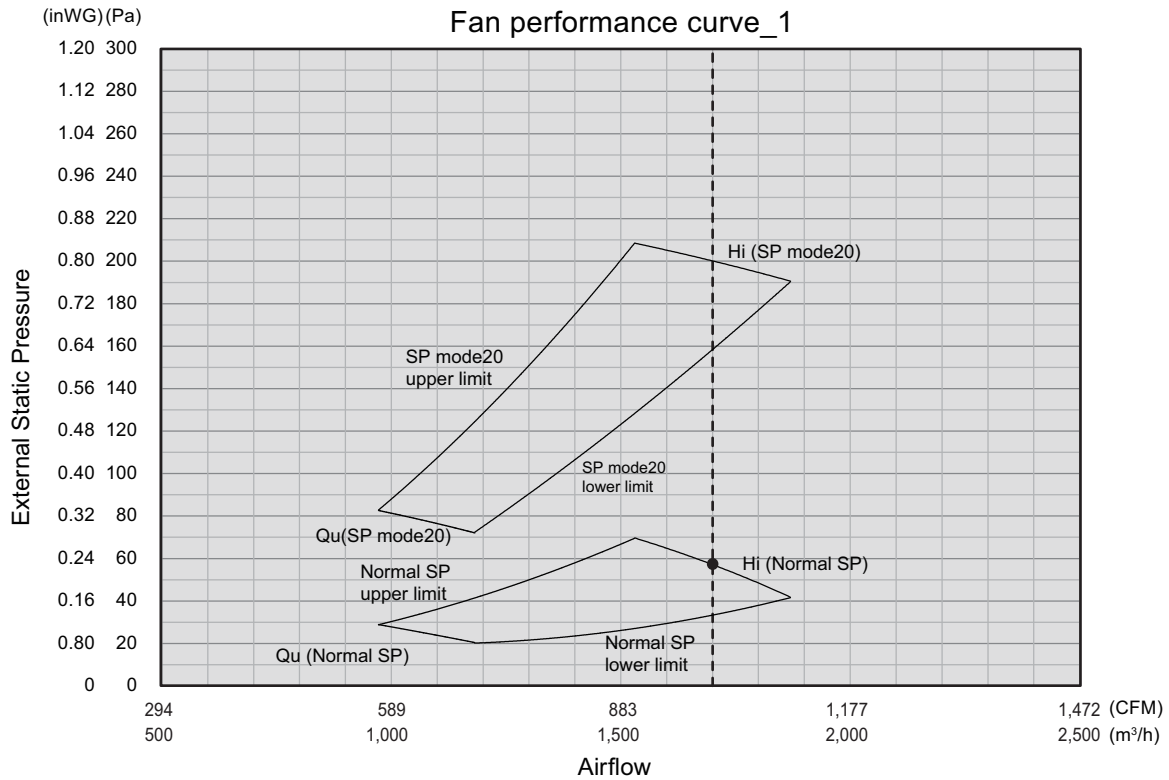

NOTES:

- Setting of the external static pressure is switchable into modes by using the remote controller.
- According to the resistance of the connecting duct, perform the setting of the external static pressure with referring "Fan performance curve_2" above.
- The default setting is set at "Normal SP".

● Characteristics of air volume and capacity

• Cooling

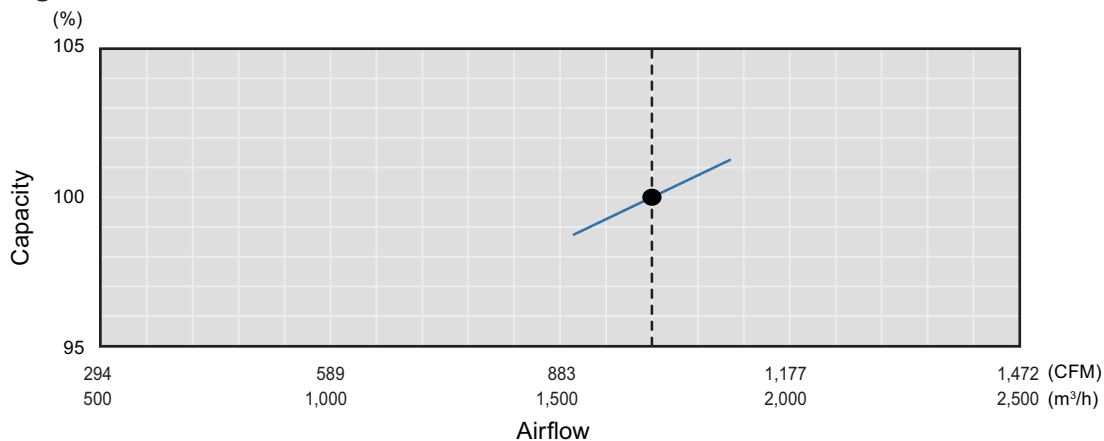

• Heating

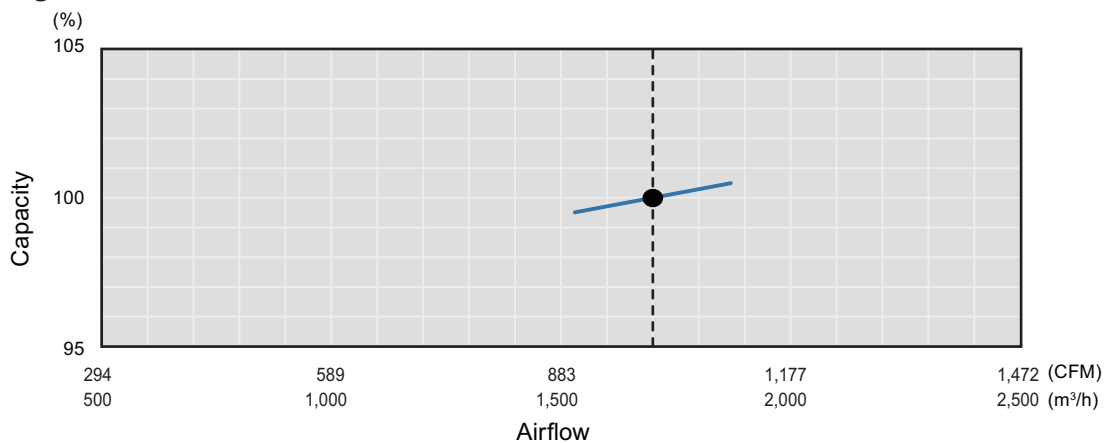

Model: ARU36RGLX

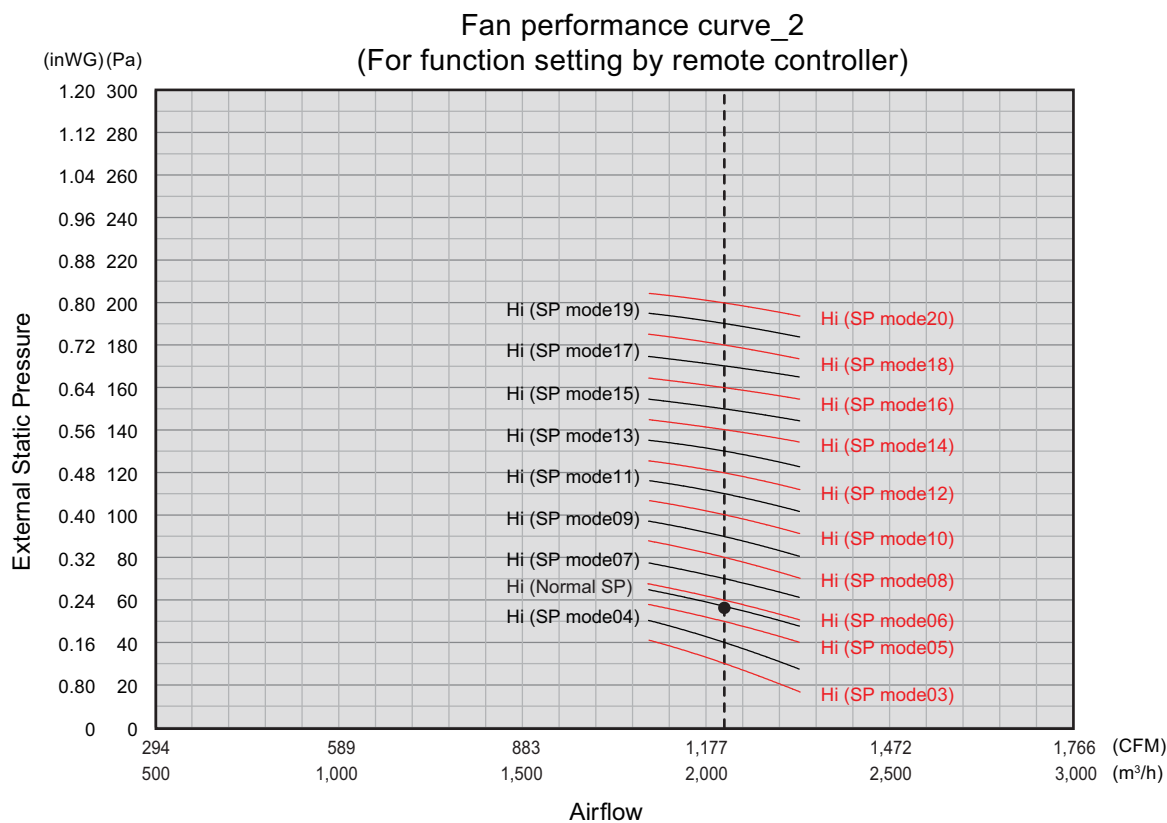
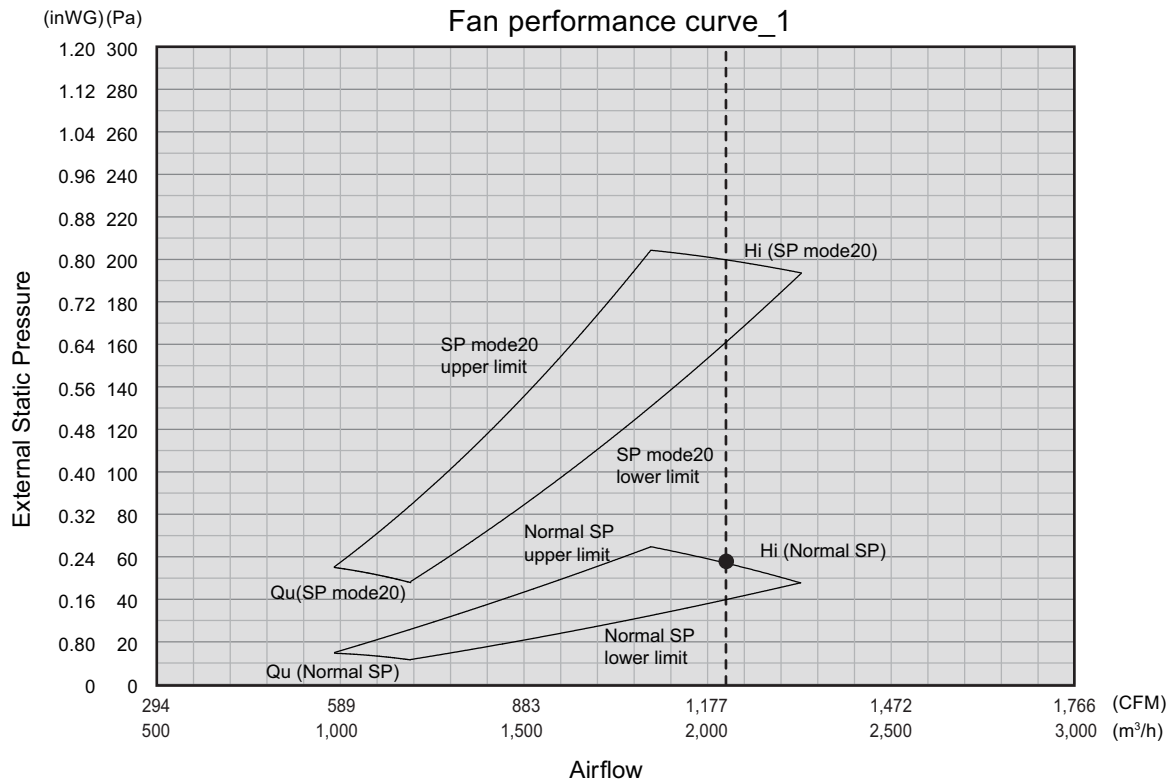

NOTES:

- Setting of the external static pressure is switchable into modes by using the remote controller.
- According to the resistance of the connecting duct, perform the setting of the external static pressure with referring "Fan performance curve_2" above.
- The default setting is set at "Normal SP".

● Characteristics of air volume and capacity

• Cooling

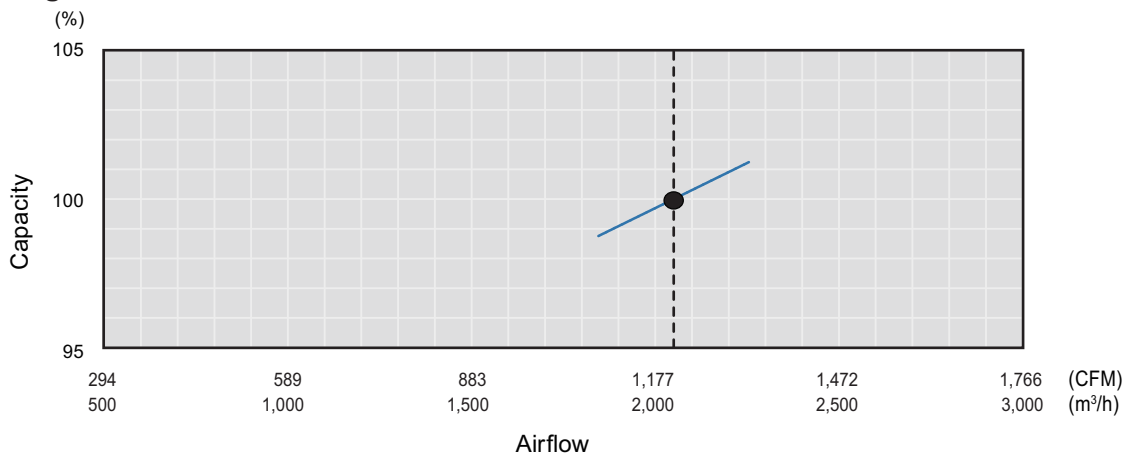

• Heating

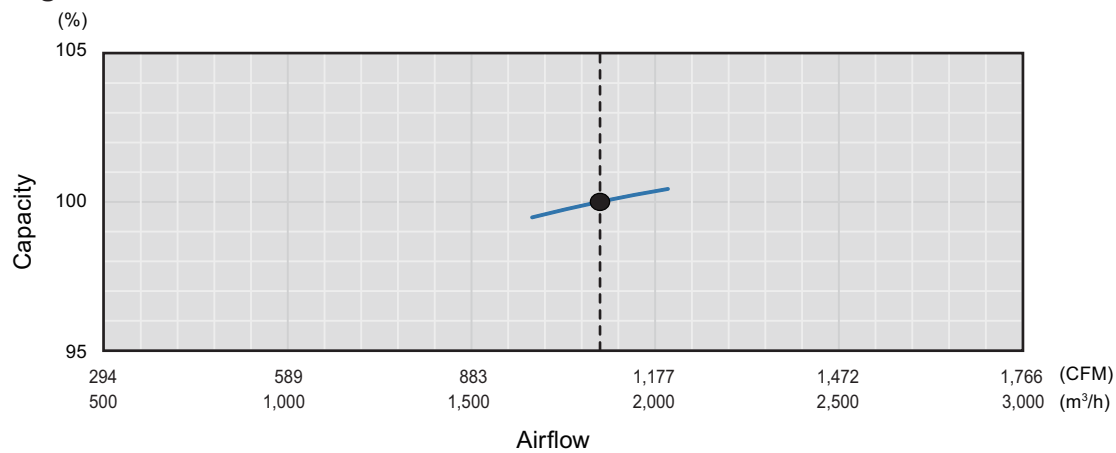

■ Model: ARU42RGLX

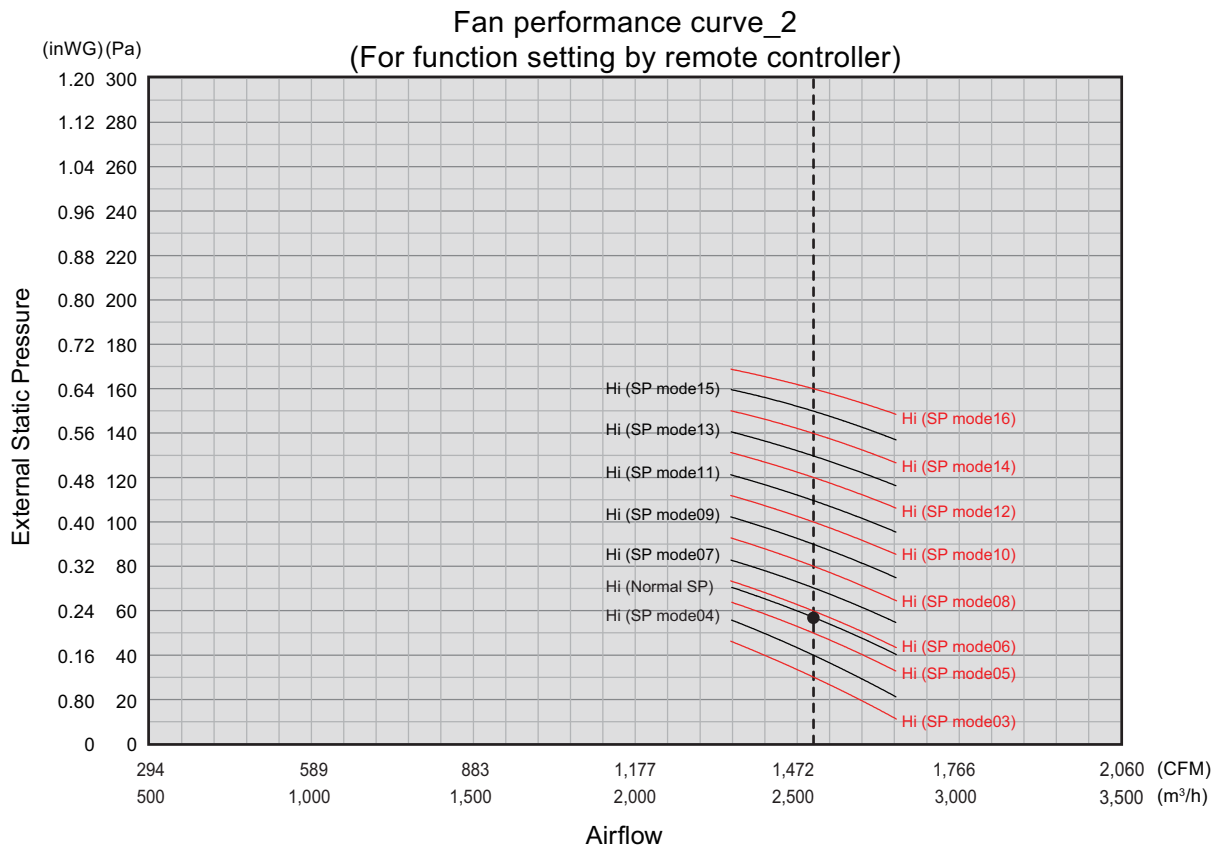
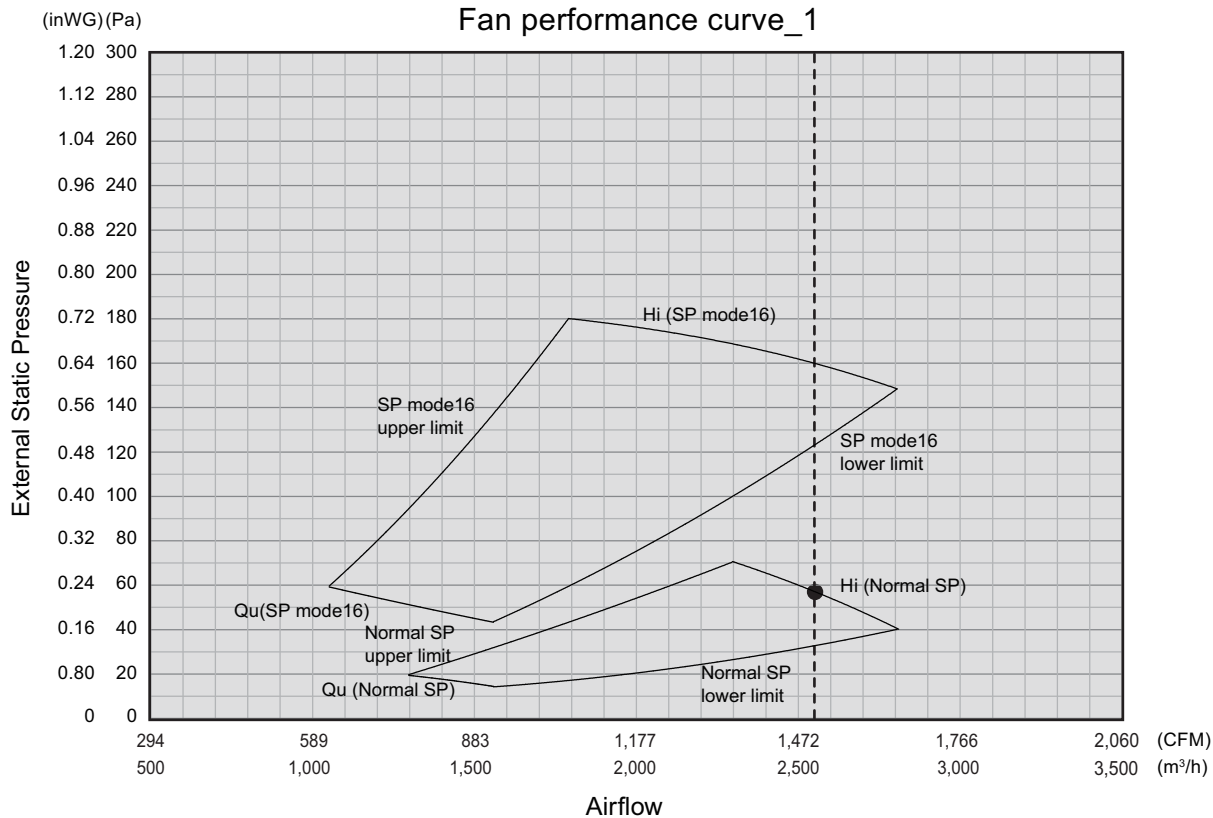

NOTES:

- Setting of the external static pressure is switchable into modes by using the remote controller.
- According to the resistance of the connecting duct, perform the setting of the external static pressure with referring "Fan performance curve_2" above.
- The default setting is set at "Normal SP".

● Characteristics of air volume and capacity

• Cooling

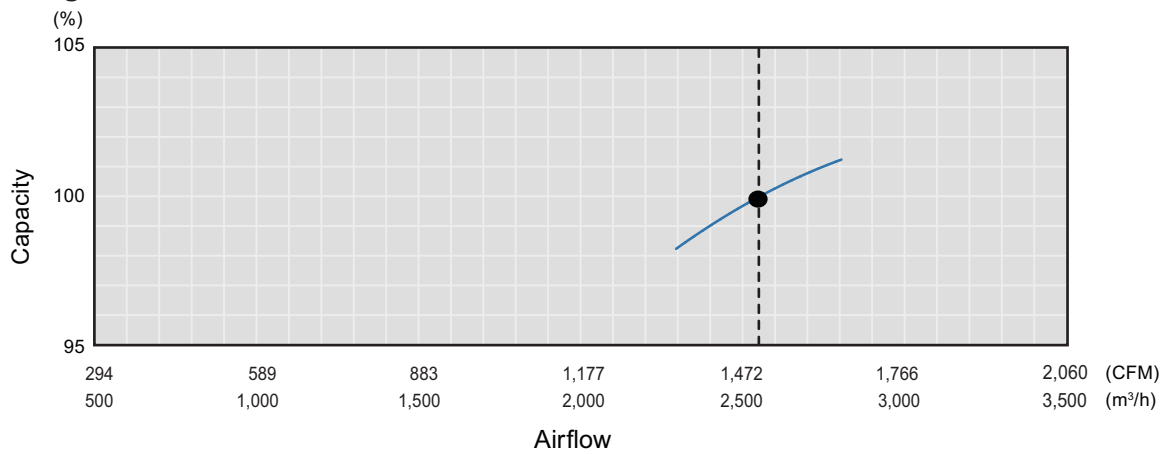

• Heating

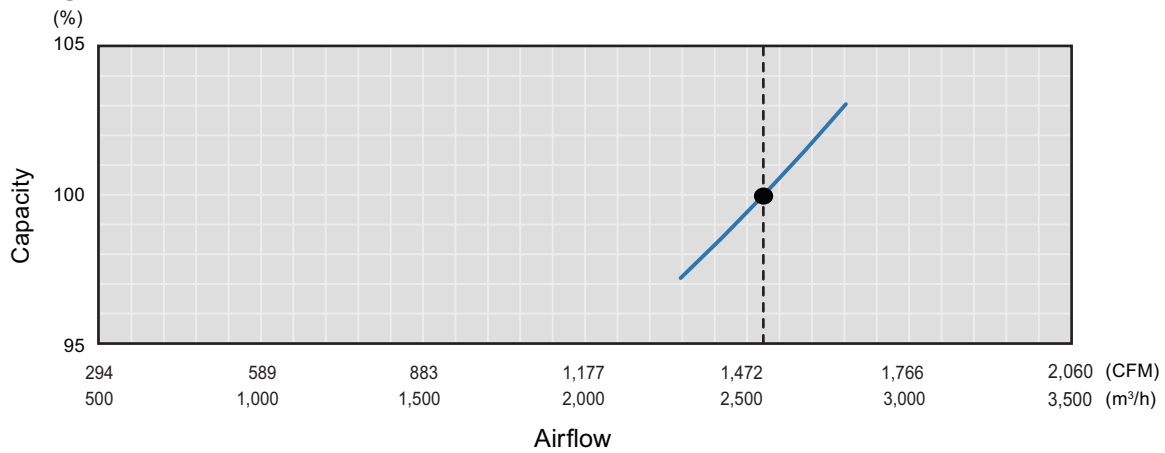

Model: ARU48RGLX

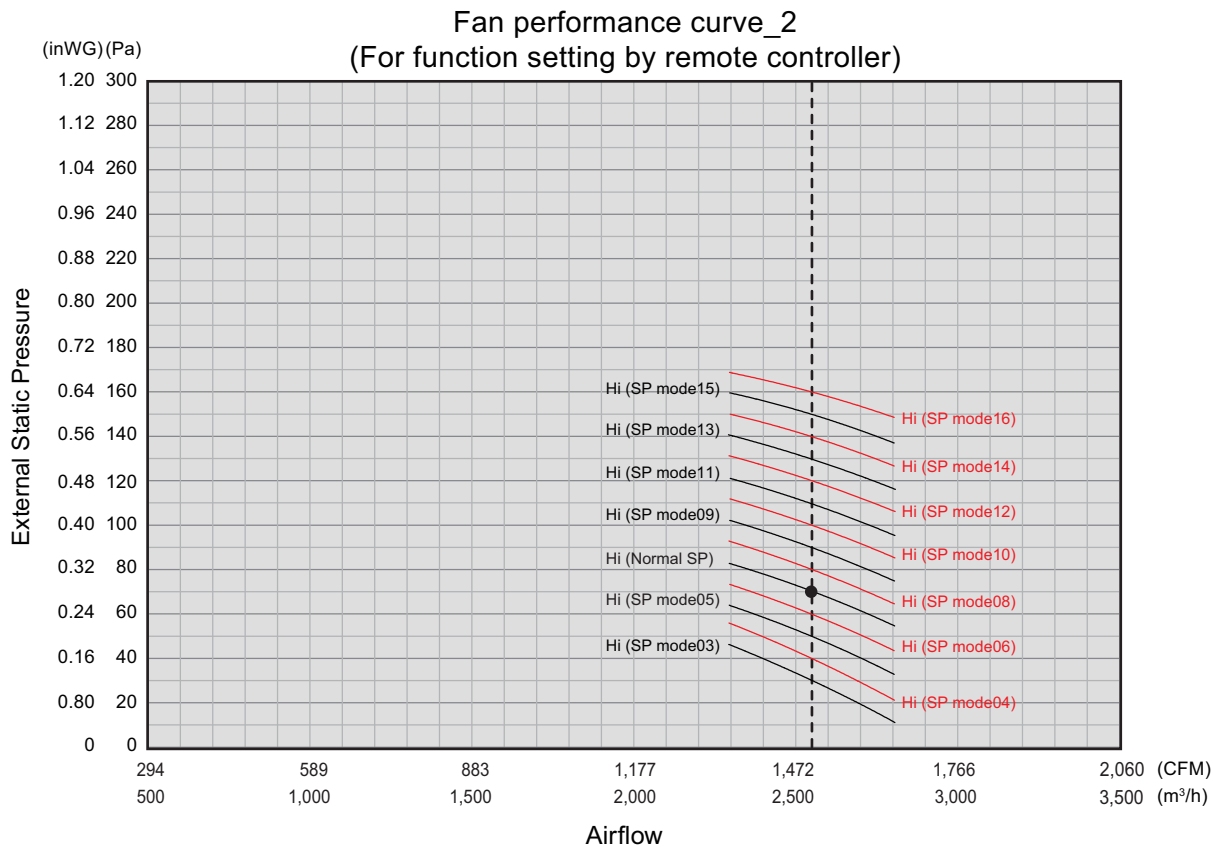
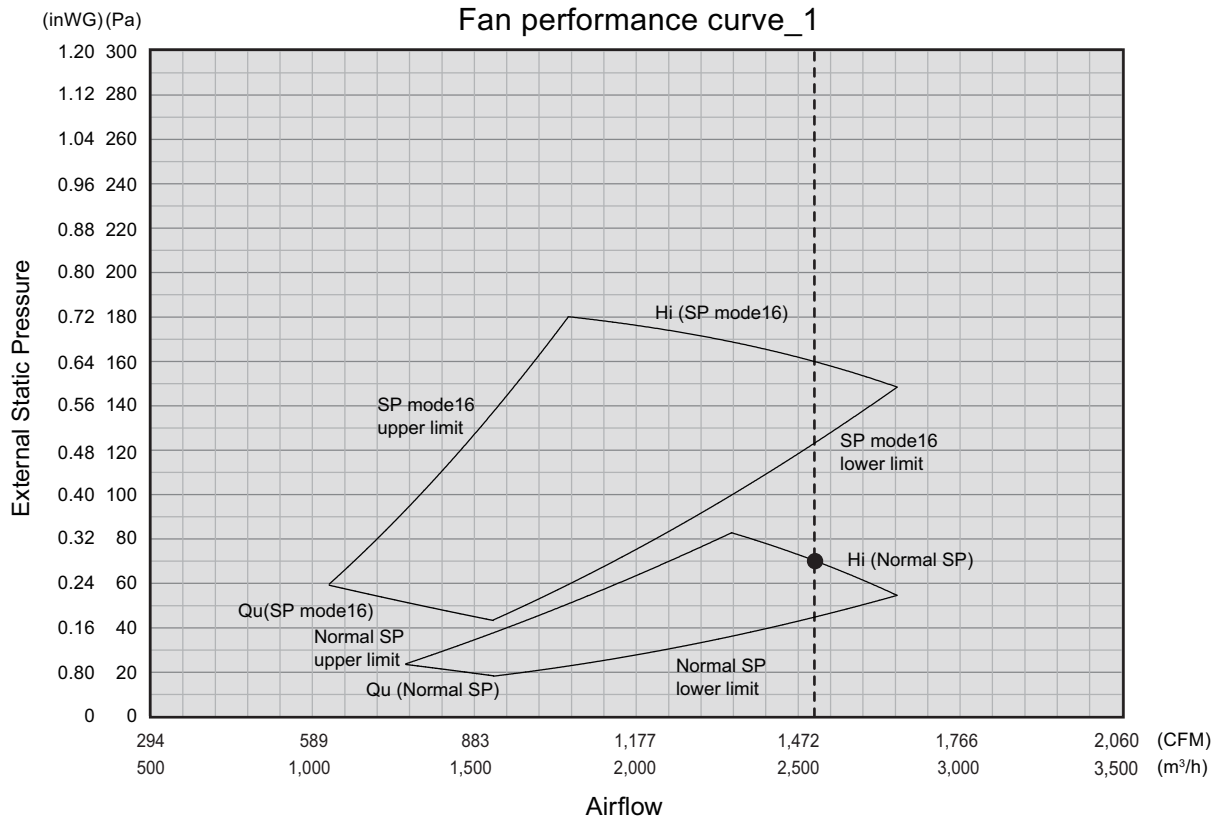

NOTES:

- Setting of the external static pressure is switchable into modes by using the remote controller.
- According to the resistance of the connecting duct, perform the setting of the external static pressure with referring "Fan performance curve_2" above.
- The default setting is set at "Normal SP".

● Characteristics of air volume and capacity

• Cooling

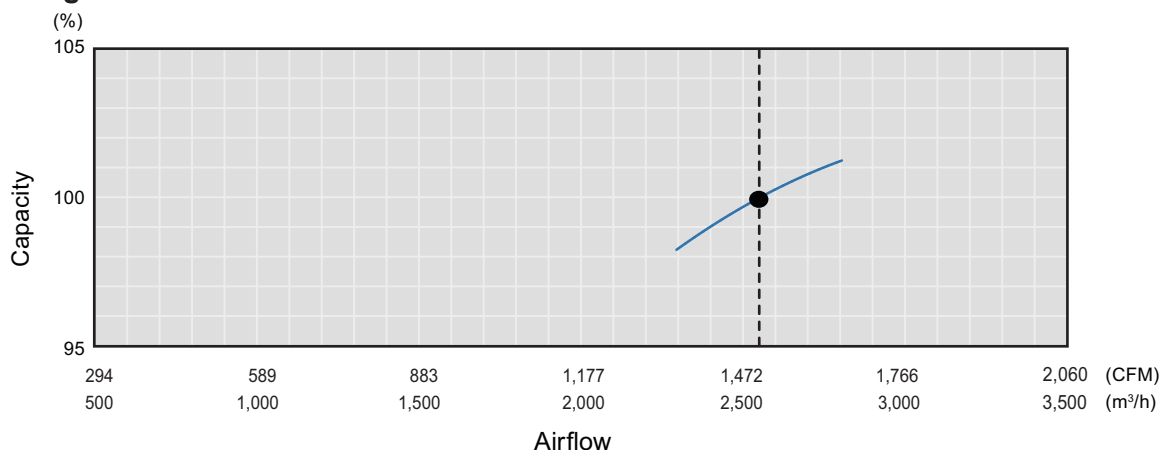

• Heating

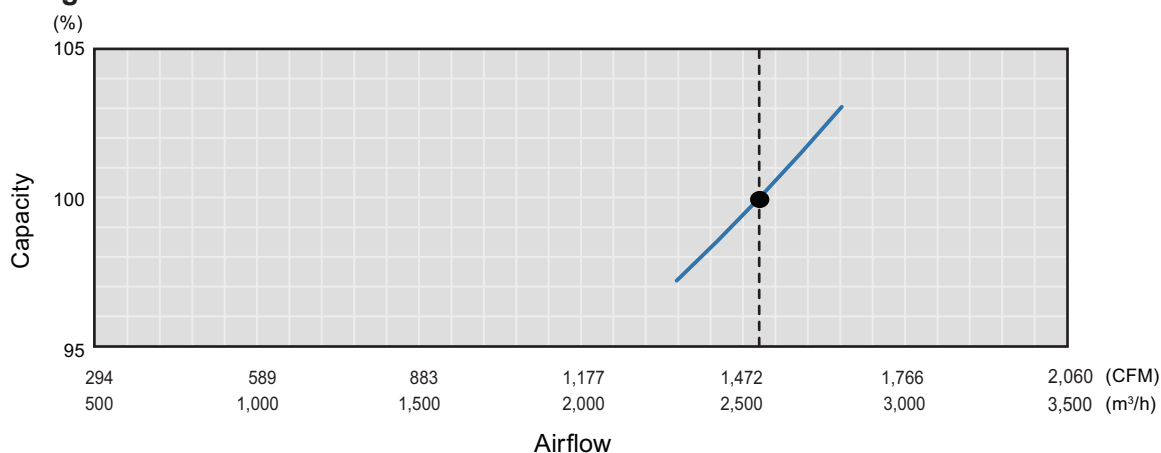

■ Automatic airflow adjustment procedures

- To start the auto setting, use setting value 32 in function number 26.
- Run the air conditioner on fan mode (High).
 - * For instructions on how to operate the air conditioner, refer to the operation manual of the remote controller.

During automatic airflow adjustment, the mode will be fixed at fan (High).
When this function is active, do not operate the outdoor unit.
- The air conditioner will run for about 1 to 8 min then stop automatically.
 - * Do not change the throttles of the inlet and outlet ports during operation.

When used in a group control system, the setting will take about 10 min.
- Turn the air conditioner off and on again.
- Check the setting value of function number 26.
 - * If the setting value has not changed, repeat the procedure from step 2.

⚠ CAUTION

When the duct or outlet installations are changed after the Automatic airflow adjustment is completed, repeat the procedure from step 1.

5-2. Airflow

■ Model: ARU12RGLX

● Cooling

Fan speed	Airflow	
HIGH	m ³ /h	850
	l/s	236
	CFM	500
MED	m ³ /h	680
	l/s	189
	CFM	400
LOW	m ³ /h	590
	l/s	164
	CFM	347
QUIET	m ³ /h	510
	l/s	142
	CFM	300

● Heating

Fan speed	Airflow	
HIGH	m ³ /h	850
	l/s	236
	CFM	500
MED	m ³ /h	680
	l/s	189
	CFM	400
LOW	m ³ /h	590
	l/s	164
	CFM	347
QUIET	m ³ /h	510
	l/s	142
	CFM	300

■ Model: ARU18RGLX

● Cooling

Fan speed	Airflow	
HIGH	m ³ /h	1,050
	l/s	292
	CFM	618
MED	m ³ /h	840
	l/s	233
	CFM	494
LOW	m ³ /h	730
	l/s	203
	CFM	430
QUIET	m ³ /h	630
	l/s	175
	CFM	371

● Heating

Fan speed	Airflow	
HIGH	m ³ /h	1,050
	l/s	292
	CFM	618
MED	m ³ /h	840
	l/s	233
	CFM	494
LOW	m ³ /h	730
	l/s	203
	CFM	430
QUIET	m ³ /h	630
	l/s	175
	CFM	371

■ Model: ARU24RGLX

● Cooling

Fan speed	Airflow	
HIGH	m ³ /h	1,360
	l/s	378
	CFM	800
MED	m ³ /h	1,080
	l/s	300
	CFM	636
LOW	m ³ /h	880
	l/s	244
	CFM	518
QUIET	m ³ /h	680
	l/s	189
	CFM	400

● Heating

Fan speed	Airflow	
HIGH	m ³ /h	1,360
	l/s	378
	CFM	800
MED	m ³ /h	1,080
	l/s	300
	CFM	636
LOW	m ³ /h	880
	l/s	244
	CFM	518
QUIET	m ³ /h	680
	l/s	189
	CFM	400

■ Model: ARU30RGLX

● Cooling

Fan speed	Airflow	
HIGH	m ³ /h	1,700
	l/s	472
	CFM	1,001
MED	m ³ /h	1,360
	l/s	378
	CFM	800
LOW	m ³ /h	1,190
	l/s	331
	CFM	700
QUIET	m ³ /h	1,070
	l/s	297
	CFM	630

● Heating

Fan speed	Airflow	
HIGH	m ³ /h	1,700
	l/s	472
	CFM	1,001
MED	m ³ /h	1,360
	l/s	378
	CFM	800
LOW	m ³ /h	1,190
	l/s	331
	CFM	700
QUIET	m ³ /h	1,070
	l/s	297
	CFM	630

■ Model: ARU36RGLX

● Cooling

Fan speed	Airflow	
HIGH	m ³ /h	2,050
	l/s	569
	CFM	1,207
MED	m ³ /h	1,640
	l/s	456
	CFM	965
LOW	m ³ /h	1,330
	l/s	369
	CFM	783
QUIET	m ³ /h	1,070
	l/s	297
	CFM	630

● Heating

Fan speed	Airflow	
HIGH	m ³ /h	1,850
	l/s	514
	CFM	1,089
MED	m ³ /h	1,640
	l/s	456
	CFM	965
LOW	m ³ /h	1,330
	l/s	369
	CFM	783
QUIET	m ³ /h	1,070
	l/s	297
	CFM	630

■ Model: ARU42RGLX

● Cooling

Fan speed	Airflow	
HIGH	m ³ /h	2,550
	l/s	708
	CFM	1,501
MED	m ³ /h	2,040
	l/s	567
	CFM	1,201
LOW	m ³ /h	1,650
	l/s	458
	CFM	971
QUIET	m ³ /h	1,430
	l/s	397
	CFM	842

● Heating

Fan speed	Airflow	
HIGH	m ³ /h	2,550
	l/s	708
	CFM	1,501
MED	m ³ /h	2,040
	l/s	567
	CFM	1,201
LOW	m ³ /h	1,650
	l/s	458
	CFM	971
QUIET	m ³ /h	1,430
	l/s	397
	CFM	842

■ Model: ARU48RGLX

● Cooling

Fan speed	Airflow	
HIGH	m ³ /h	2,550
	l/s	708
	CFM	1,501
MED	m ³ /h	2,040
	l/s	567
	CFM	1,201
LOW	m ³ /h	1,650
	l/s	458
	CFM	971
QUIET	m ³ /h	1,430
	l/s	397
	CFM	842

● Heating

Fan speed	Airflow	
HIGH	m ³ /h	2,550
	l/s	708
	CFM	1,501
MED	m ³ /h	2,040
	l/s	567
	CFM	1,201
LOW	m ³ /h	1,650
	l/s	458
	CFM	971
QUIET	m ³ /h	1,430
	l/s	397
	CFM	842

6. Operation noise (sound pressure)

6-1. Noise level curve

Model: ARU12RGLX

● Cooling

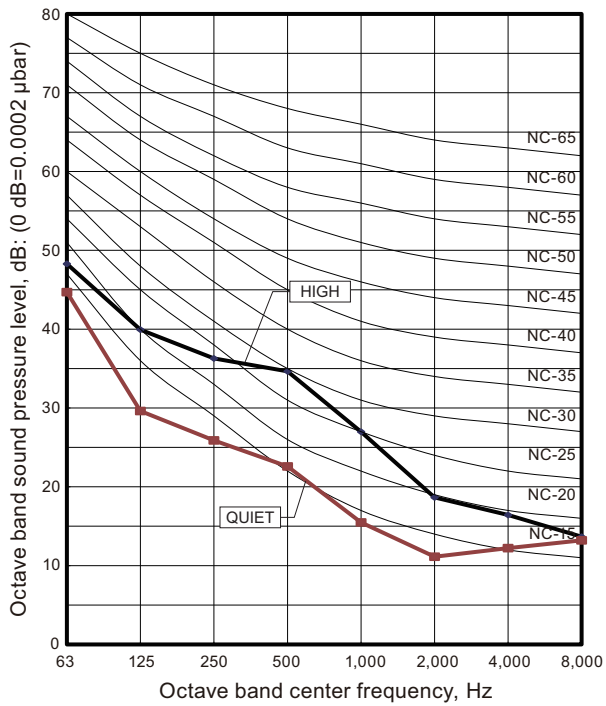

● Heating

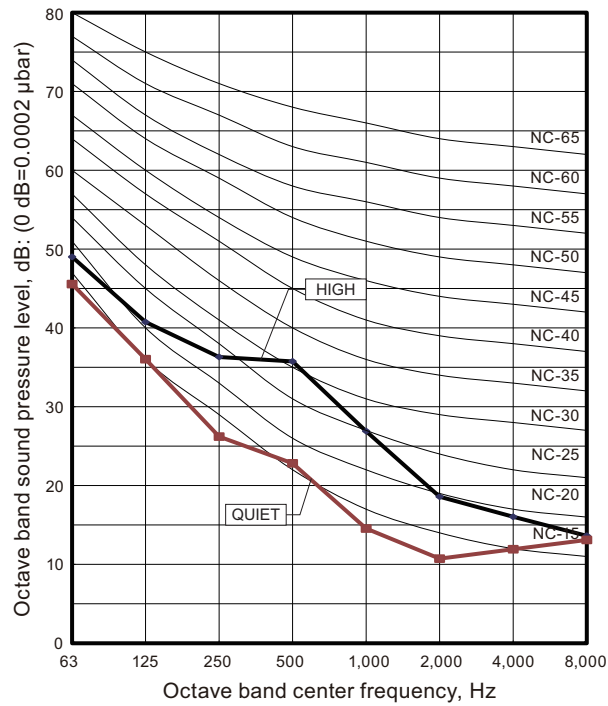

Model: ARU18RGLX

● Cooling

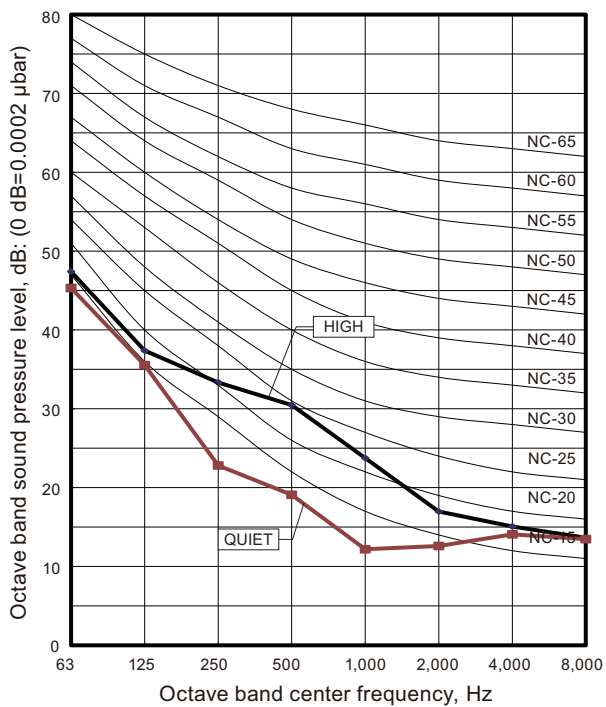

● Heating

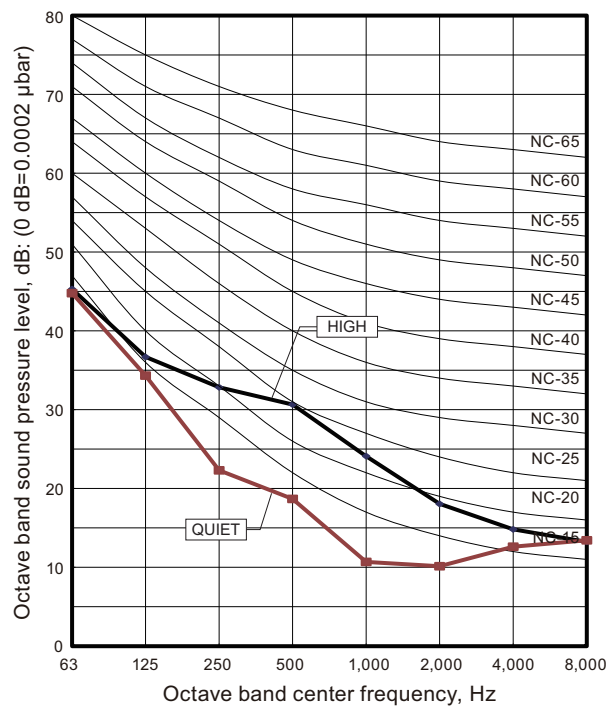

Model: ARU24RGLX

Cooling

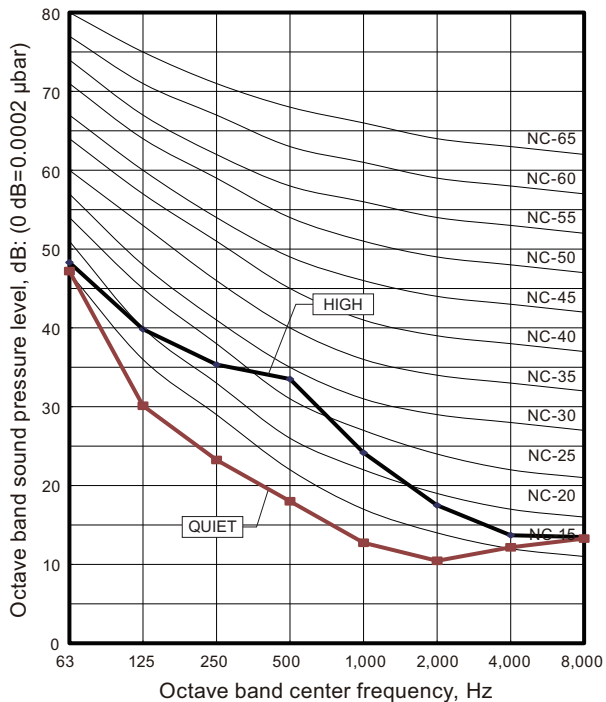

Heating

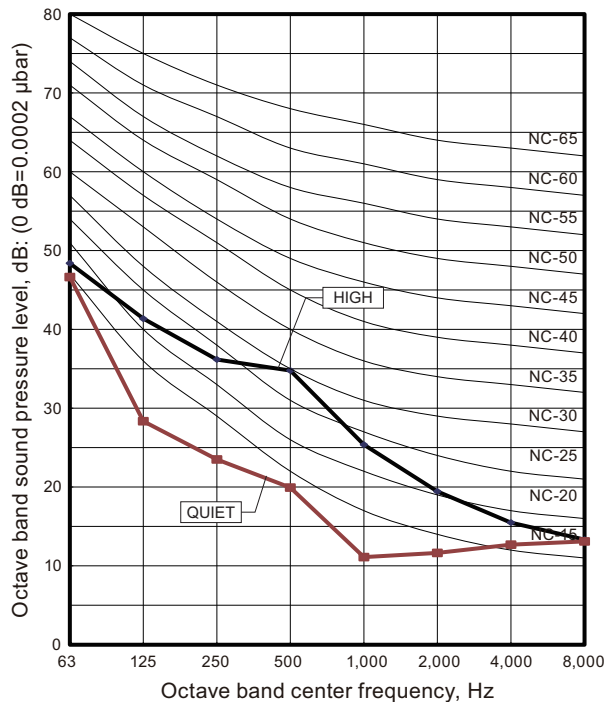

Model: ARU30RGLX

Cooling

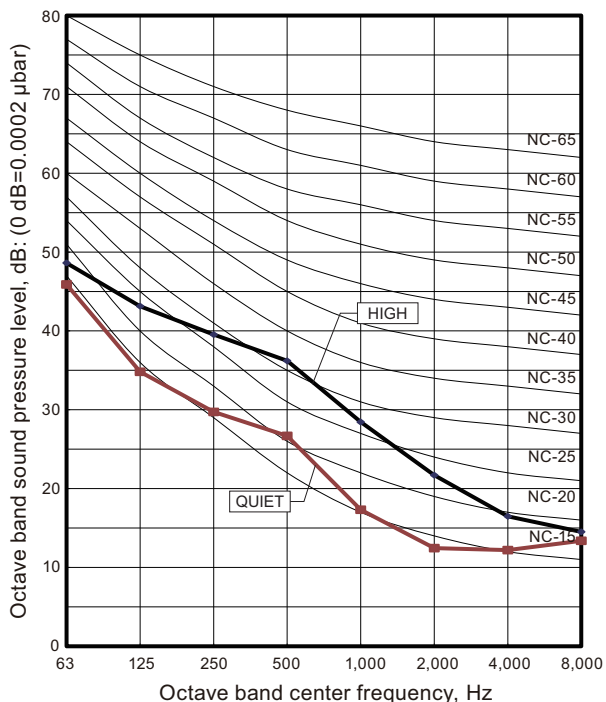

Heating

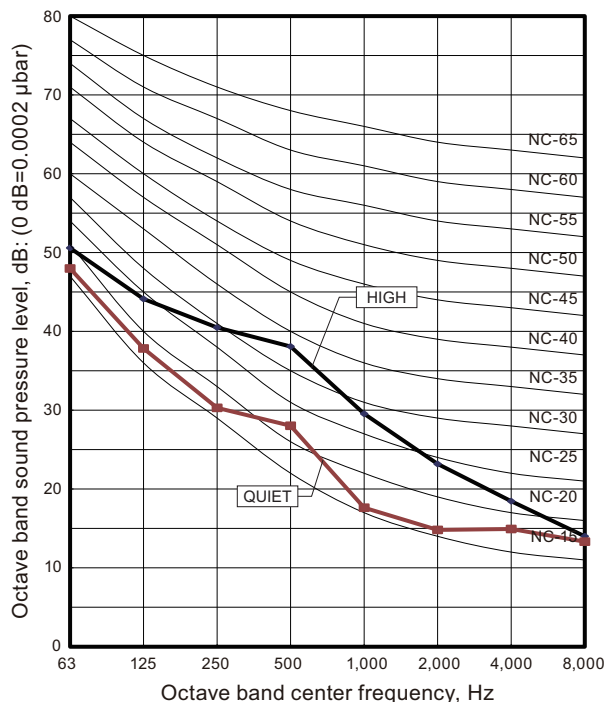

Model: ARU36RGLX

Cooling

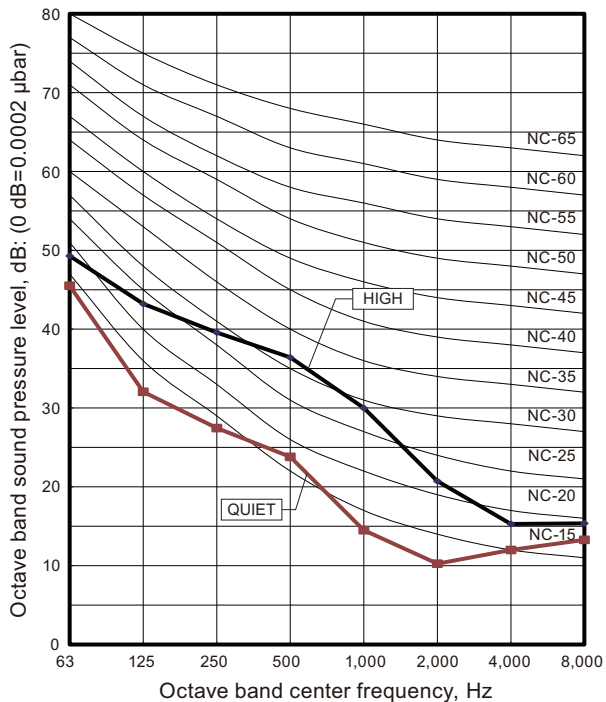

Heating

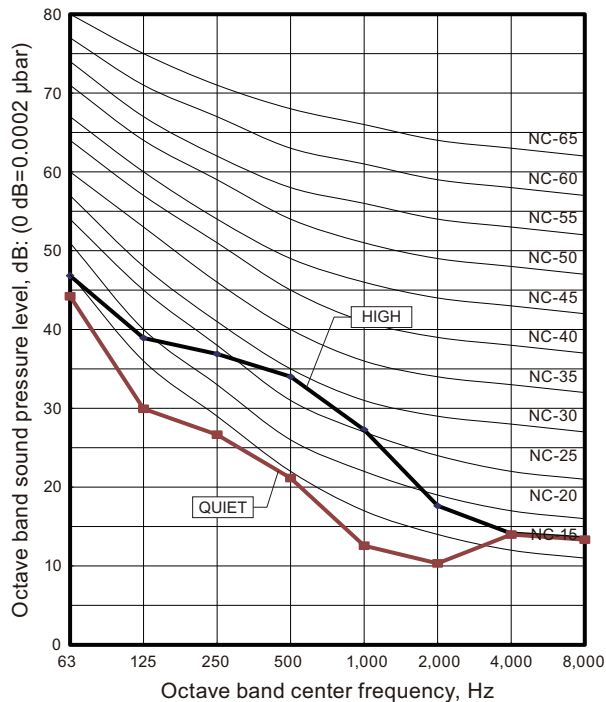

Model: ARU42RGLX

Cooling

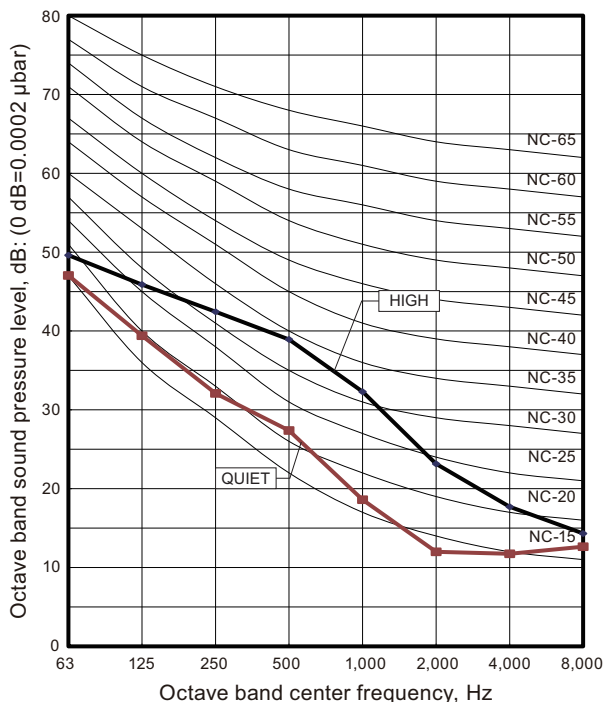

Heating

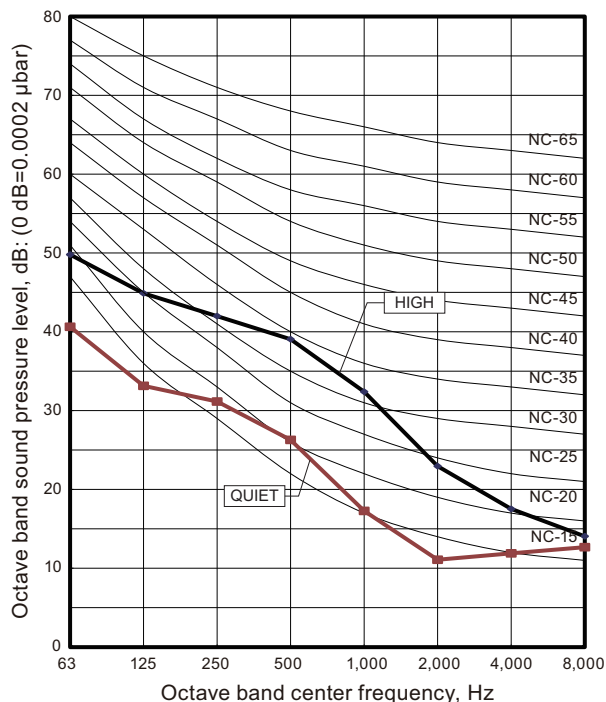

Model: ARU48RGLX

● Cooling

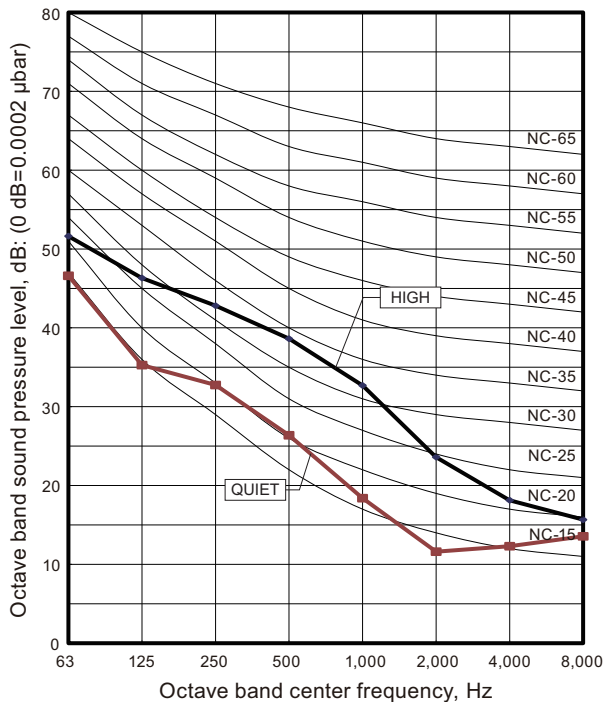

● Heating

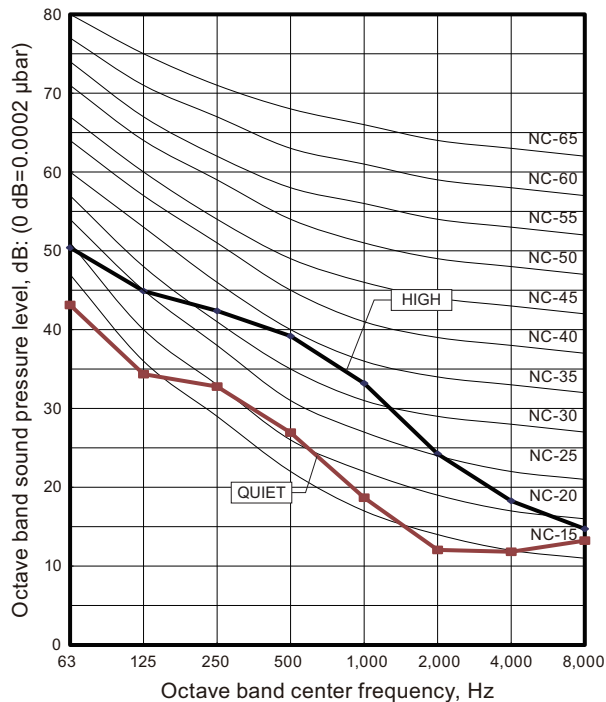

6-2. Sound level check point

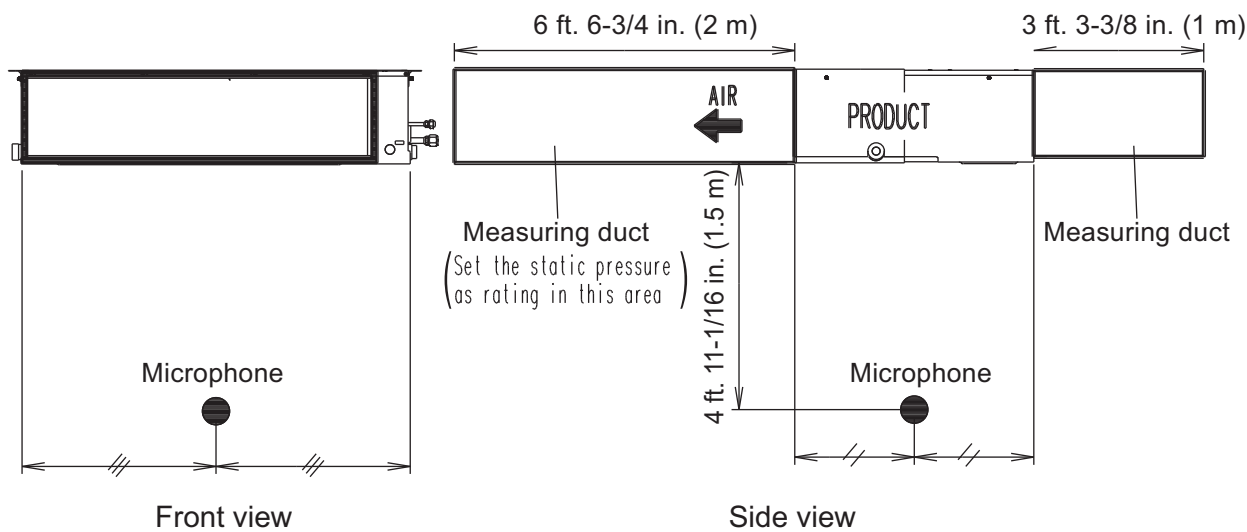

7. Safety devices

Type of protection	Protection form	Model	
		ARU12RGLX	ARU18RGLX ARU24RGLX
Circuit protection	Current fuse (PCB*)	250 V, 5 A	
Fan motor protection	Thermal protection program	Activate	239±59 °F (115±15 °C) Fan motor stop
		Reset	158 °F (70 °C) Fan motor restart
	Current protection	Activate	1.64 A

Type of protection	Protection form	Model	
		ARU30RGLX	ARU36RGLX ARU42RGLX ARU48RGLX
Circuit protection	Current fuse (PCB*)	250 V, 10 A	
Fan motor protection	Thermal protection program	Activate	212±41 °F (100±5 °C) Fan motor stop
		Reset	158±59 °F (70±15 °C) Fan motor restart
	Current protection	Activate	7.58 A

*: Printed Circuit Board

8. External input and output

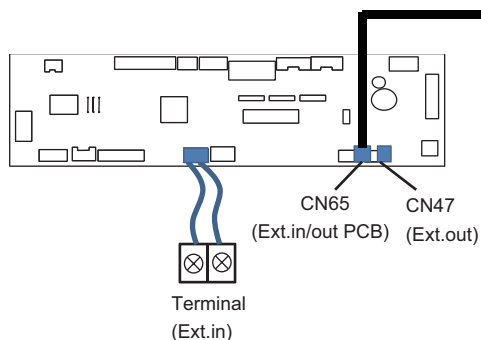

Fig. Indoor unit PCB

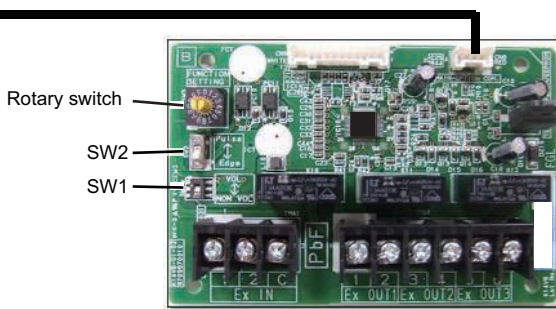

Fig. External input and output PCB

PCB	External input	External output	Connector	Input select	Input signal	External connect kit (Optional parts)
Indoor unit	Operation/Stop Forced stop	—	Terminal	Dry contact	Edge	—
	—	Operation status	CN47	—	—	UTY-XWZXZG
		Error status				
		Indoor unit fan operation status				
External heater output						
External input and output (UTY-XCSX)	Operation/Stop	—	Input 1/ Input 2	Dry contact/ Apply voltage	Edge/ Pulse	—
	Forced thermostat off		Input 1		Edge	
	—	Operation status	Output 1 Output 2 Output 3	—	—	—
		Error status				
Indoor unit fan operation status						
External heater output						

8-1. External input

- “Operation/Stop” mode or “Forced stop” mode can be selected with function setting of indoor unit.
- A twisted pair cable (22AWG) should be used. Maximum length of cable is 492 ft (150 m).
- The wire connection should be separate from the power cable line.

■ Indoor unit

Indoor unit functions such as Operation/Stop can be done by using indoor unit terminals.

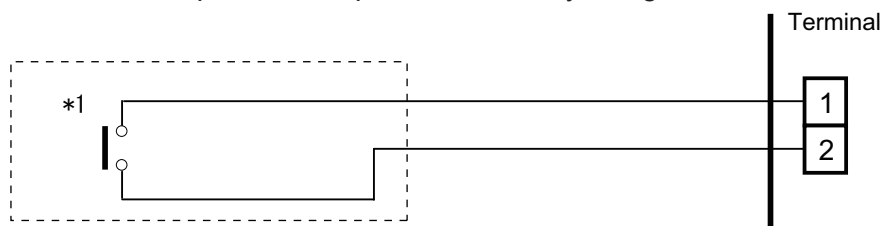

*1: The switch can be used on the following condition: DC 12 V to 24 V, 1 mA to 15 mA.

External input and output PCB

The indoor unit Operation/Stop can be set by using the input terminal on the PCB.

Input select

Use either one of these types of terminals according to the application. (Both types of terminals cannot be used simultaneously.)

- Dry contact

In case of internal power supply, set the slide switch of SW1 to "NON VOL" side.

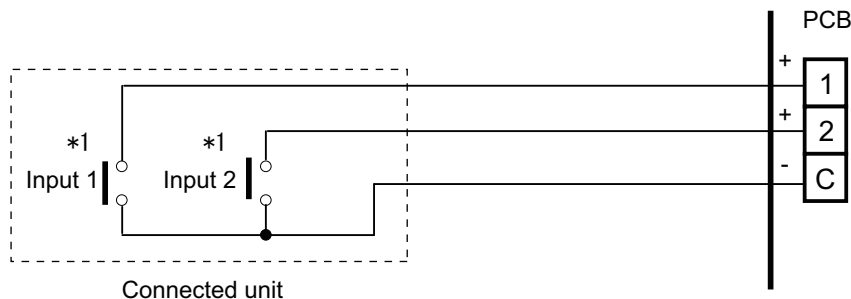

*1: The switches can be used on the following condition: DC 12 V to 24 V, 1 mA to 15 mA.

- Apply voltage

In case of external power supply, set the slide switch of SW1 to "VOL" side.

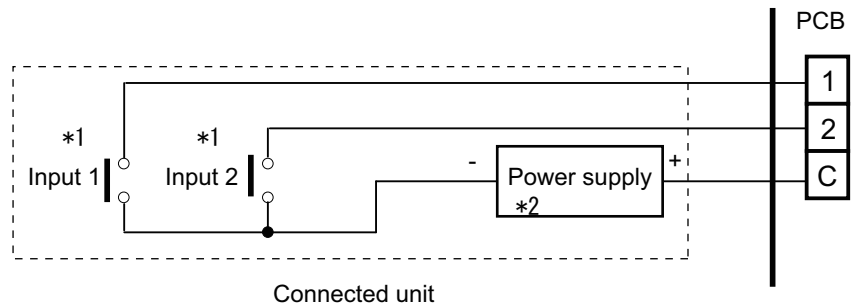

*1: The switches can be used on the following condition: DC 12 V to 24 V, 1 mA to 15 mA.

*2: Make the power supply DC 12 V to 24 V 10 mA or more.

8-2. External output

Use an external output cable with appropriate external dimension, depending on the number of cables to be installed.

Indoor unit

- A twisted pair cable (22AWG) should be used. Maximum length of cable is 82 ft (25 m).
- Output voltage: High DC 12 V \pm 2 V, Low 0 V.
- Permissible current: 50 mA
- For details, refer to Chapter 8-3. "[Combination of external input and output](#)" on page 55.

When indicator, etc. are connected directly

Example: Function setting 60 is set to "00"

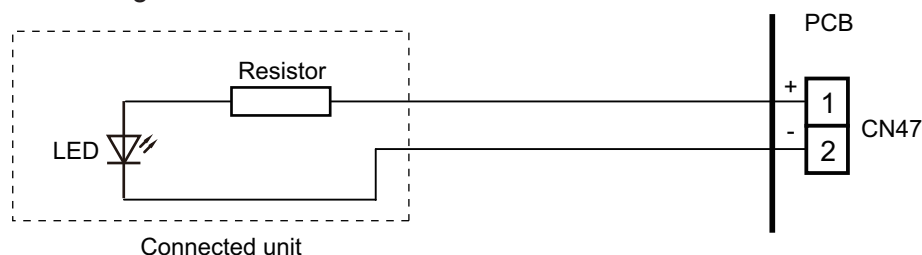

When connecting with a device equipped with a power supply

Example: Function setting 60 is set to "00"

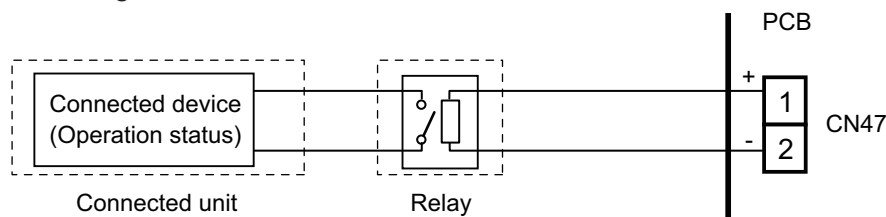

External input and output PCB

- A twisted pair cable (22AWG) should be used.
- Permissible voltage and current: DC 5 V to 30 V / 3 A, AC 30 V to 250 V / 3 A
- For details, refer to Chapter 8-3. "[Combination of external input and output](#)" on page 55.

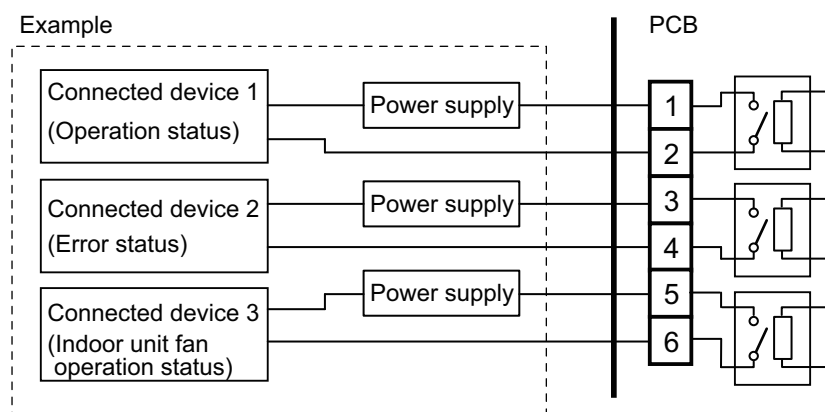

8-3. Combination of external input and output

By combining the function setting of the indoor unit and rotary switch setting of the External input and output PCB, you can select various combinations of functions.

Combination examples of external input and output are as follows:

Mode	Function setting	External input and output PCB (Rotary SW)	External input			
			Indoor unit Input	External input and output PCB		
			Terminal	Input 1	Input 2	Signal type
0-1	60-00	1	Operation/Stop (Function setting 46-00) or Emergency stop (Function setting 46-01) or Forced stop (Function setting 46-02)	Operation/Stop	Not available	Edge
				Operation	Stop	Pulse
0-2	60-00	2		Forced Thermostat OFF	Not available	Edge
1	60-01	3		Mechanical cooling Off		
2	60-02	4		Forced thermostat Off		
3	60-03	5		Mechanical cooling On		
4	60-04	6		Mechanical cooling On		
5	60-05	7		Forced thermostat Off		
6	60-06	8		Forced thermostat Off		
7	60-07	9		Mechanical cooling Off		
8	60-08	A		Forced thermostat Off		
9	60-09	B		Forced Thermostat OFF		
10	60-10	C	Forced Thermostat OFF			
11	60-11	D	Forced Thermostat OFF			
12	60-12	D	Forced Thermostat OFF			

Mode	Function setting	External input and output PCB (Rotary SW)	External output			
			Indoor unit Output	External input and output PCB		
			CN47	Output 1	Output 2	Output 3
0-1	60-00	1	Operation/Stop	Operation/Stop	Error status	Indoor unit fan operation status
0-2	60-00	2	Operation/Stop	Error status	Indoor unit fan operation status	External heater output
1	60-01	3	Cooling thermostat On	Error status	Indoor unit fan operation status	External heater output
2	60-02	4	Cooling thermostat On	Error status	Remote controller output	External heater output
3	60-03	5	Cooling thermostat On	Cooling high/low output	Remote controller output	External heater output
4	60-04	6	Cooling thermostat On	Error status	Remote controller output	Cooling high/low output
5	60-05	7	Heating thermostat On	Error status	Indoor unit fan operation status	External heater output
6	60-06	8	Operation/Stop	Error status	Indoor unit fan operation status	Heating thermostat On
7	60-07	9	Cooling thermostat On	Error status	Heating thermostat On	External heater output
8	60-08	A	Cooling thermostat On	Heating thermostat On	Remote controller output	External heater output
9	60-09	B	Error status	Operation/Stop	Indoor unit fan operation status	External heater output
10	60-10	C	Indoor unit fan operation status	Operation/Stop	Error status	External heater output
11	60-11	D	External heater output	Operation/Stop	Indoor unit fan operation status	Error status
12	60-12	D	Set point attainment status	Operation/Stop	Indoor unit fan operation status	Error status

NOTE: Input of Operation/Stop depends on the setting of function setting 46.

00: Operation/Stop mode 1 (R.C. enabled)

01: (Setting prohibited)

02: Forced stop

03: Operation/Stop mode 2 (R.C. disabled)

Input signal type

- Indoor unit
Input signal type is only "Edge".

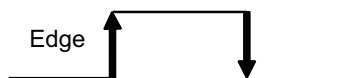

- External input and output PCB
The input signal type can be selected.

Signal type (edge or pulse) can be switched by the DIP switch 2 (SW2) on the External input and output PCB.

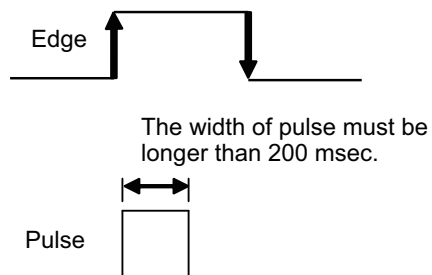

8-4. Details of function

■ Control input function

● When function setting is "Operation/Stop" mode 1

- In the case of "Edge" input

Function setting /	Rotary SW of External input and output PCB	External input		Input signal	Command
46-00	-	Input of indoor unit	Terminal	Off → On	Operation
				On → Off	Stop
	60-00 / 1	External input and output PCB	Input 1	Off → On	Operation
				On → Off	Stop

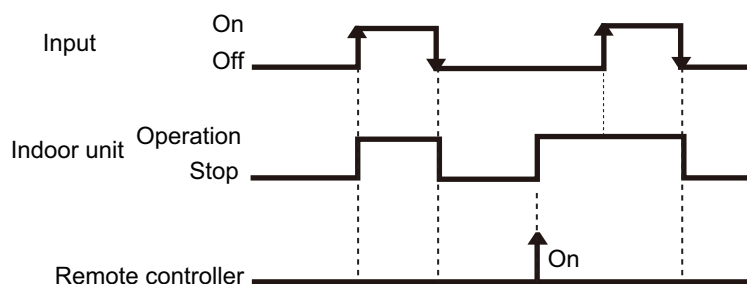

- In the case of "Pulse" input

Function setting /	Rotary SW of External input and output PCB	External input		Input signal	Command
46-00	60-00 / 1	External input and output PCB	Input 1	Pulse	Operation
			Input 2	Pulse	Stop

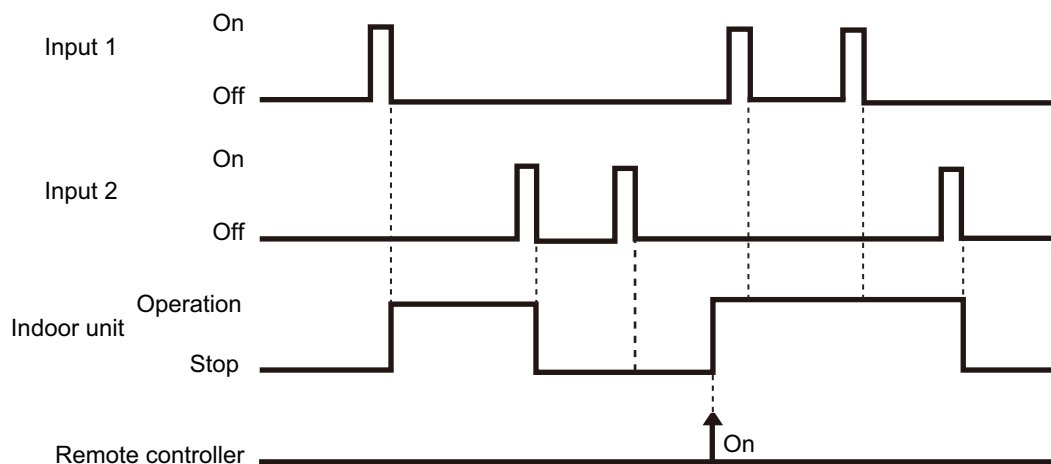

NOTES:

- The last command has priority.
- The indoor units within the same remote controller group operates in the same mode.

● When function setting is "Forced stop" mode

- In the case of "Edge" input

Function setting /	Rotary SW of External input and output PCB	External input		Input signal	Command
46-02	-	Input of indoor unit	Terminal	Off → On	Forced stop
				On → Off	Normal
	60-00 / 1	External input and output PCB	Input 1	Off → On	Forced stop
				On → Off	Normal

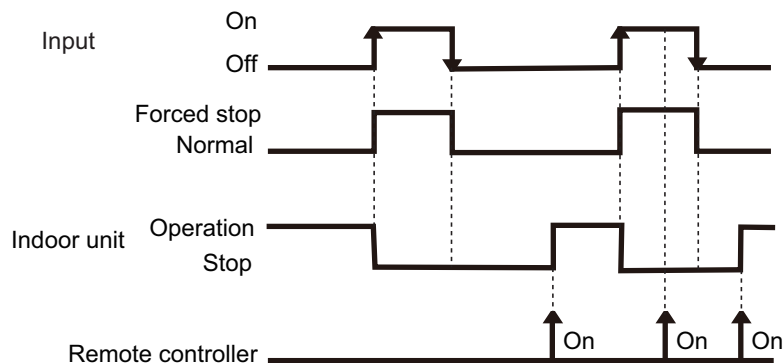

- In the case of "Pulse" input

Function setting /	Rotary SW of External input and output PCB	External input		Input signal	Command
46-02	60-00 / 1	External input and output PCB	Input 1	Pulse	Forced stop
			Input 2	Pulse	Normal

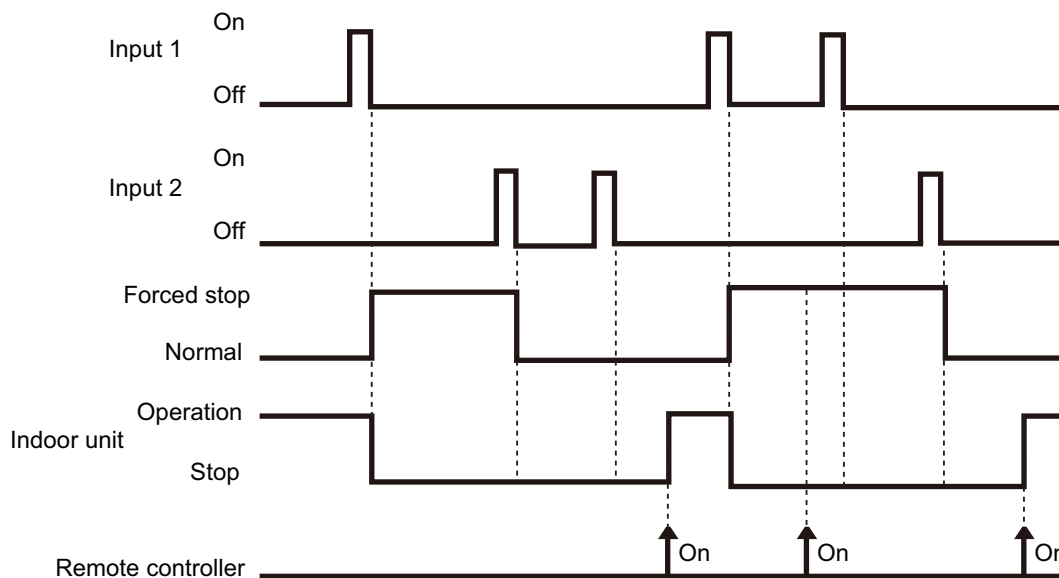

NOTES:

- When the forced stop is triggered, indoor unit stops and Operation/Stop operation by the remote controller is restricted.
- When forced stop function is used with forming a remote controller group, connect the same equipment to each indoor unit within the group.

● When function setting is "Operation/Stop" mode 2

- In the case of "Edge" input

Function setting /	Rotary SW of External input and output PCB	External input		Input signal	Command
46-03	-	Input of indoor unit	Terminal	Off → On	Operation
				On → Off	Stop (R.C. disabled)
	60-00 / 1	External input and output PCB	Input 1	Off → On	Operation
				On → Off	Stop (R.C. disabled)

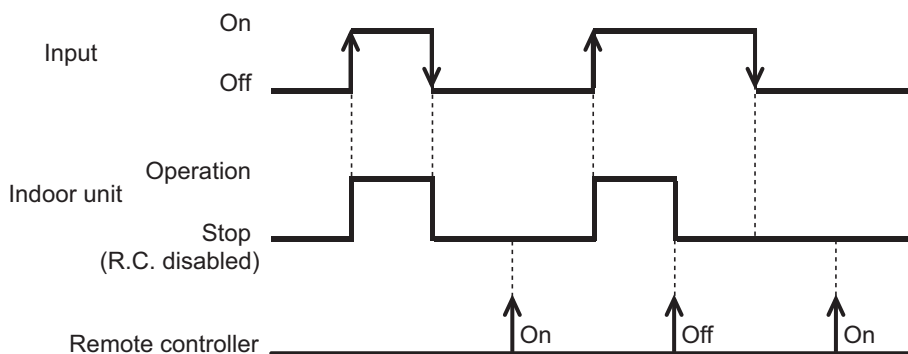

- In the case of "Pulse" input

Function setting /	Rotary SW of External input and output PCB	External input		Input signal	Command
46-03	60-00 / 1	External input and output PCB	Input 1	Pulse	Operation
			Input 2	Pulse	Stop (R.C. disabled)

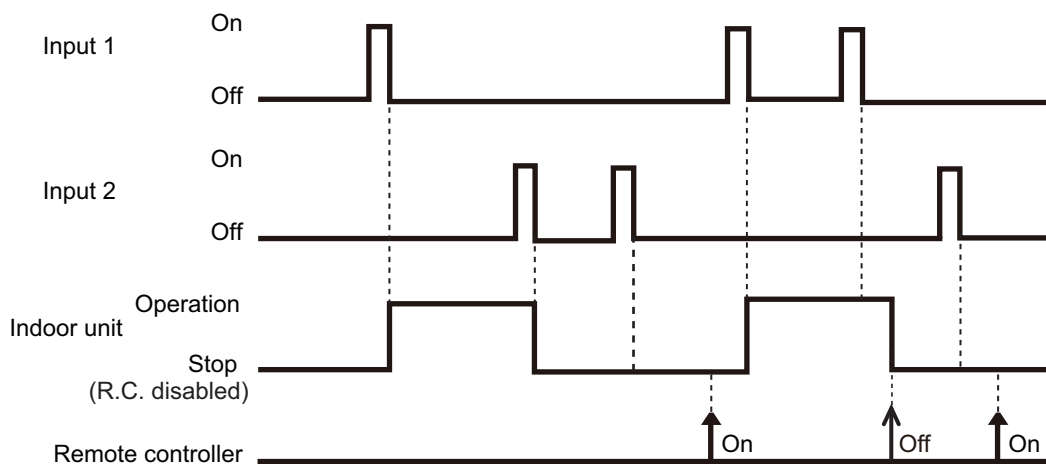

NOTES:

- When "Operation/Stop" mode 2 function is used with forming a remote controller group, connect the same equipment to each indoor unit within the group.

■ Forced thermostat off function

Function setting /	Rotary SW of External input and output PCB	External input		Input signal	Command
60-00 / 2 60-02 / 4 60-05 / 7 60-06 / 8 60-08 / A 60-09 / B 60-10 / C 60-11 / D		External input and output PCB	Input 1	Off → On	Thermostat off
				On → Off	Normal operation

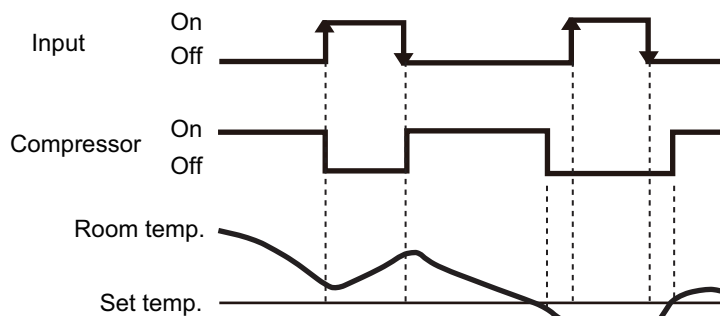

■ Control output function

Function setting /	Rotary SW of External input and output PCB	External output		Output signal	Command
60-00 / 1, 2 60-06 / 8		Output of indoor unit	CN47	Low → High	Operation
				High → Low	Stop
60-00 / 1 60-09 / B 60-10 / C 60-11 / D		External input and output PCB	Output 1	Off → On	Operation
				On → Off	Stop

The output is low when the unit is stopped.

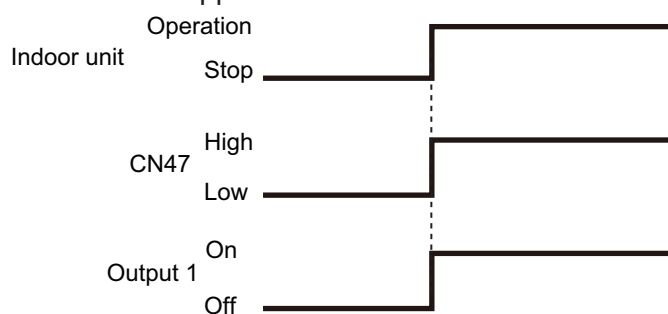

■ Error status

Function setting / Rotary SW of External input and output PCB	External output		Output signal	Command		
60-09 / B	Output of indoor unit	CN47	Low → High	Error		
			High → Low	Normal		
60-00 / 2 60-01 / 3 60-02 / 4 60-04 / 6 60-05 / 7 60-06 / 8 60-07 / 9	External input and output PCB	Output 1	Off → On	Error		
			On → Off	Normal		
			60-00 / 1 60-10 / C	Output 2	Off → On	Error
					On → Off	Normal
			60-11 / D	Output 3	Off → On	Error
					On → Off	Normal

The output is ON when an error is generated for the indoor unit.

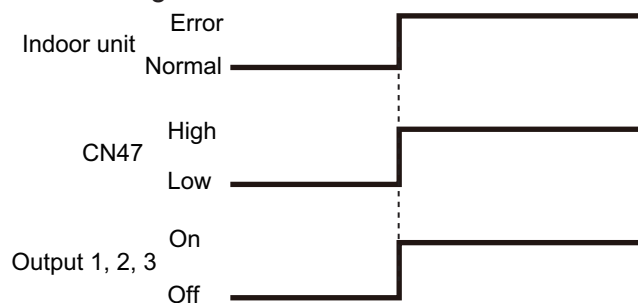

Indoor unit fan operation status

Function setting / Rotary SW of External input and output PCB	External output	Output signal	Command
60-10 / C	Output of indoor unit CN47	Low → High	Fan run
		High → Low	Fan stop
60-00 / 2 60-01 / 3 60-05 / 7 60-06 / 8 60-09 / B 60-11 / D	External input and output PCB Output 2	Off → On	Fan run
		On → Off	Fan stop
60-00 / 1	Output 3	Off → On	Fan run
		On → Off	Fan stop

Output signal	Condition
On Low → High	The indoor unit fan is operating.
Off High → Low	The fan is stopped or during cold air prevention. During thermostat off when in dry mode operation.

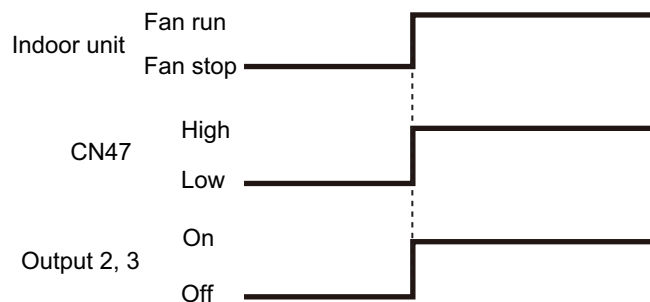

External heater output

Control	Primary heater	Auxiliary heater	Function setting	
			Indoor unit	Wired R. C.
			Control switching external heaters No. 61	Sensor activation*2
Auxiliary heater control 1	Heat pump	External device*1	61-00	—
Auxiliary heater control 2	Heat pump	External device	61-01	—
Heat pump prohibition control	External device	None	61-02	On (Enabled)
Auxiliary heater control by outdoor temperature 1	Heat pump	External device	61-03	On (Enabled)
Auxiliary heater control by outdoor temperature 2	Heat Pump	External device	61-04	On (Enabled)
Auxiliary heater control by outdoor temperature 3	Heat Pump	External device	61-05	On (Enabled)
Auxiliary heat pump control	External device	Heat pump	61-06	On (Enabled)
Auxiliary heat pump control by outdoor temperature 1	External device	Heat pump	61-07	On (Enabled)
Auxiliary heat pump control by outdoor temperature 2	External device	Heat pump	61-08	On (Enabled)
Auxiliary heat pump control by outdoor temperature 3	External device	Heat pump	61-09	On (Enabled)

NOTES:

- After turning off the heater, 3 minutes of standby time is required by next power-on of the heater.
- For items marked “—” in the table, any of validate or invalidate of the setting are acceptable.
- *1: External device means Hot water, Electrical heater, etc.
- *2: Sensor activation:
 - Setting change from the factory setting is required.
 - Indoor unit fan setting will be on for safety reason without sensor activation of wired remote controller.

● Installation configuration of individual connection

External heating device is installed individually. (No use of indoor unit fan)

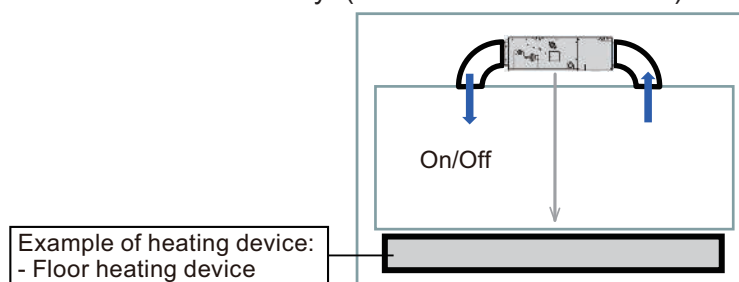

⚠ WARNING

- When auxiliary heater is installed, always set “indoor unit fan setting for external heater”.
- Design and install external heater appropriately with considering its protection.

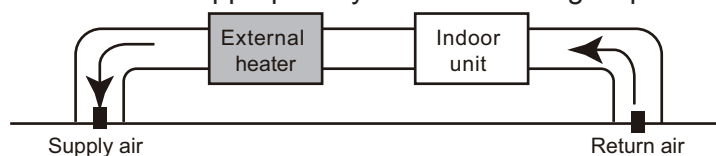

- Inappropriate designing and installation of external heater may cause a fire by emitted heat from the external heater.
- Fujitsu General Ltd. is not responsible for inappropriate designing or installation of external heating device.

● Auxiliary equipment control by room temperature

Auxiliary equipment control is switchable by room temperature. Auxiliary equipment switching is performed for each room temperature divided to following 3 zones.

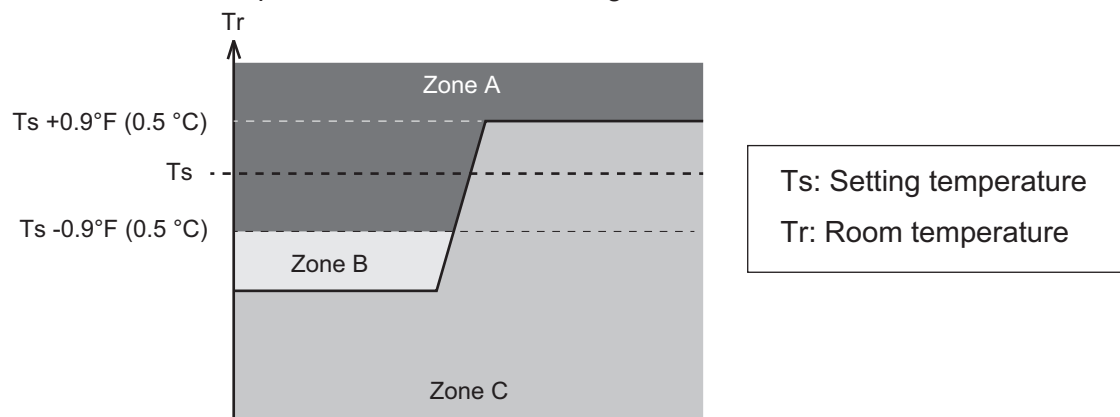

Zone	Application	When temperature dropping		When temperature rising	
		Primary	Auxiliary	Primary	Auxiliary
A	Both of primary and auxiliary equipment is unnecessary.	Off	Off	Off	Off
B	Primary heater only. When room temperature stays in zone B for a long time, auxiliary equipment also operates.	On	Off*1	—	—
C	Auxiliary equipment also operates.	On	On*2	On	On*2

*1: For standby time for auxiliary equipment operation, refer to indoor unit function number 71 "[Contents of function setting](#)" on page 85.

*2: When indoor unit function number 61 is set to "00", auxiliary equipment operates according to the following conditions.

- $T_s - T_r > 21.6 \text{ }^\circ\text{F}$ ($-12.0 \text{ }^\circ\text{C}$): Auxiliary equipment turn off.
- $T_s - T_r > 18.0 \text{ }^\circ\text{F}$ ($-10.0 \text{ }^\circ\text{C}$): Auxiliary equipment turn on.

● Auxiliary heater control 1

Operation	Condition
Heater on	Heater is on as shown in following diagram of heating temperature.
Heater off	<ul style="list-style-type: none"> • Heater is off as shown in following diagram of heating temperature. • Other than heating mode • Error occurred • Forced thermostat off • Fan stop protection

- Temperature of heater on (Thon): Adjustable by function number 62 (Operating temperature switching of external heaters).
- All control temperatures will shift by adjusting “Thon”.

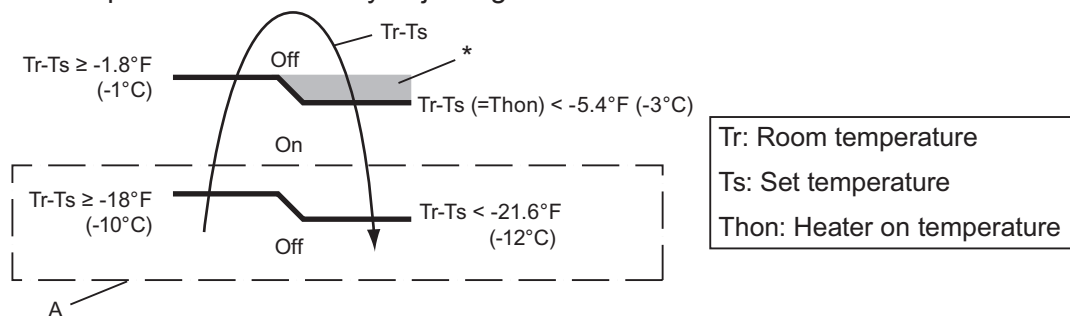

*: When room temperature stays in this zone for a specific time, auxiliary heater is turned on. For details, refer to function number 71.

Example: When set temperature (Ts) is 72°F (22°C) (Factory setting),

- and room temperature (Tr) increases above 53.6°F (12°C), signal output is on.
- and room temperature (Tr) increases above 69.8°F (21°C), signal output is off.
- and room temperature (Tr) decreases below 66.2°F (19°C), signal output is on.
- and room temperature (Tr) decreases below 50°F (10°C), signal output is off.

● Auxiliary heater control 2

Control that excludes “A” from "Auxiliary heater control 1" on page 67.

Operation	Condition
Heater on	Heater is on as shown in following diagram of heating temperature.
Heater off	<ul style="list-style-type: none"> • Heater is off as shown in following diagram of heating temperature. • Other than heating mode • Error occurred • Forced thermostat off • Fan stop protection

- Temperature of heater on (Thon): Adjustable by function number 62 (Operating temperature switching of external heaters).
- All control temperatures will shift by adjusting “Thon”.

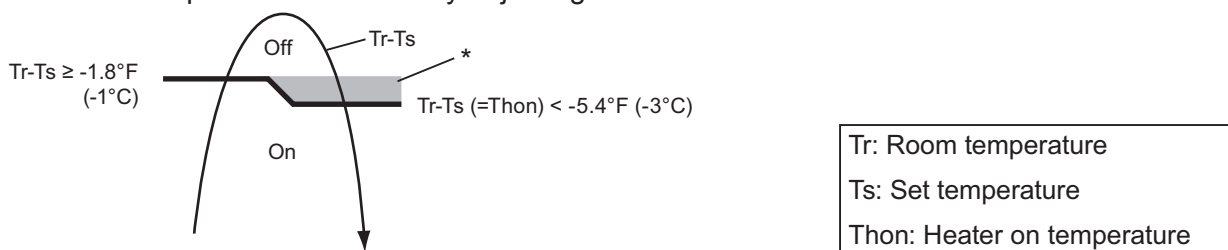

*: When room temperature stays in this zone for a specific time, auxiliary heater is turned off. For details, refer to function number 71.

● Heat pump prohibition control

Perform heating by external heater only. Indoor unit is continuous thermostat off.

Operation			Condition
Heater on			Heater is on as shown in following diagram of heating temperature.
Heater off	DIP-SW101-3 On Indoor unit fan setting for external heater	On Enabled	<ul style="list-style-type: none"> • Heater is off as shown in following diagram of heating temperature. • Other than heating mode • Error occurred • Forced thermostat off • Fan stop protection
	DIP-SW101-3 Off Indoor unit fan setting for external heater	Off Disabled	<ul style="list-style-type: none"> • Heater is off as shown in following diagram of heating temperature. • Other than heating mode • Error occurred • Forced thermostat off

- Temperature of heater on (Thon): Adjustable by function number 62 (Operating temperature switching of external heaters).
- All control temperatures will shift by adjusting "Thon".

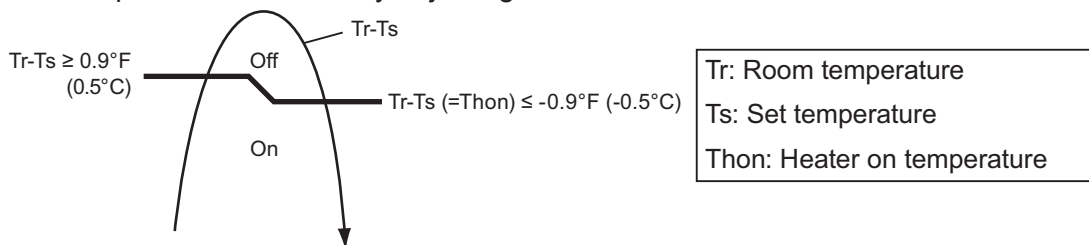

• Operation status

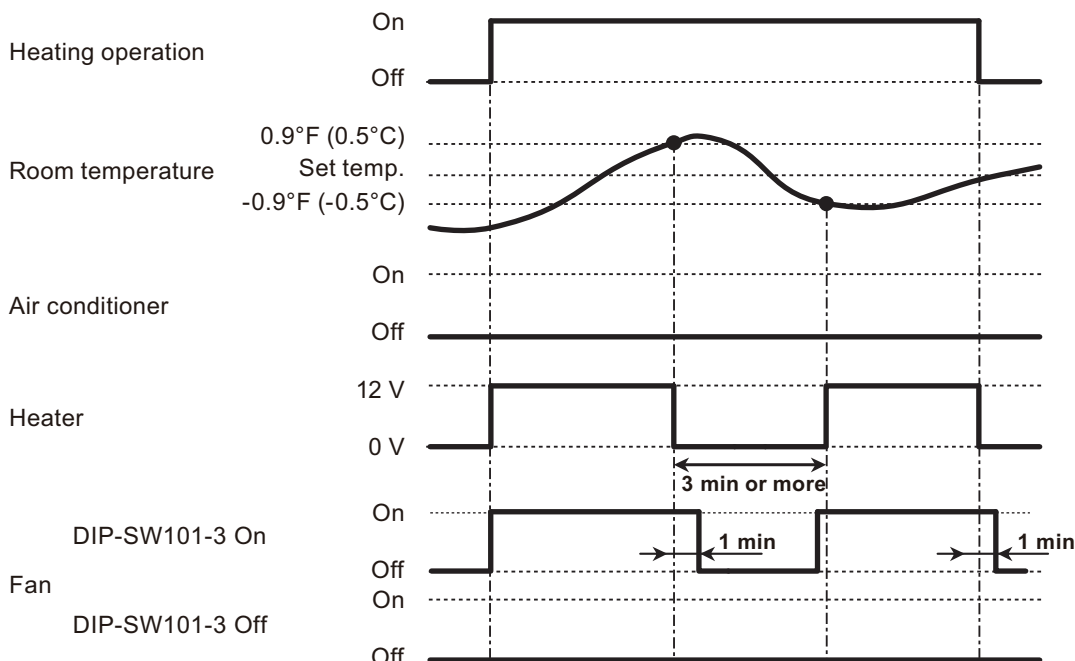

NOTE: In following operations, compressor will be on.

- Other than heating
- Test run

● Auxiliary heater control by outdoor temperature 1

This control selects heat pump or external heater according to the outdoor temperature. When outdoor temperature is high, the heating is performed by using heat pump only.

Operation		Condition
Heater on		Heater is on as shown in following diagram of heating temperature.
Heater off	DIP-SW101-3 On Indoor unit fan setting for external heater Enabled	<ul style="list-style-type: none"> Heater is off as shown in following diagram of heating temperature. Other than heating mode Error occurred Forced thermostat off Heat pump only zone Fan stop protection
	DIP-SW101-3 Off Indoor unit fan setting for external heater Disabled	<ul style="list-style-type: none"> Heater is off as shown in following diagram of heating temperature. Other than heating mode Error occurred Forced thermostat off Heat pump only zone

- Temperature of heater on (Thon): Adjustable by function number 62 (Operating temperature switching of external heaters).
- All control temperatures will shift by adjusting “Thon”.
- Outdoor temperature zone boundary A and B: Adjustable individually by function setting number 66 and 67.

• External heater output

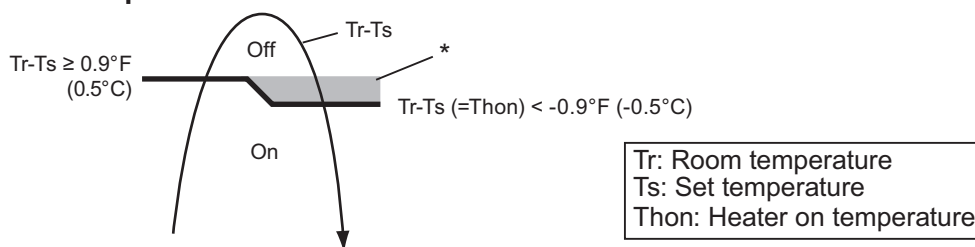

*: When room temperature stays in this zone for a specific time, auxiliary heater is turned on. For details, refer to function number 71.

• Outdoor temperature zone

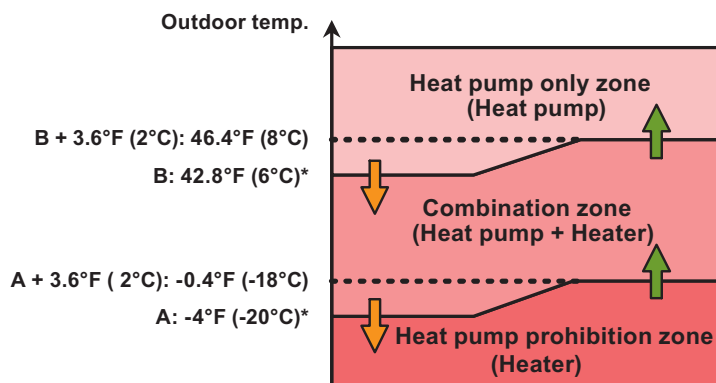

*: Adjustable by function setting 66 and 67

• Operation status

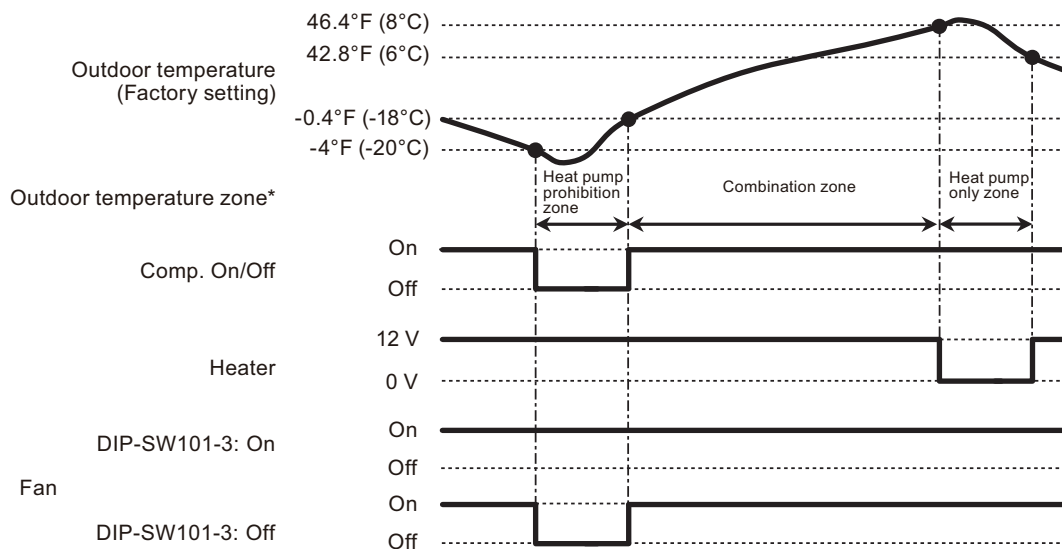

*: The outdoor temperature zone transition from one to another will stay in that zone for minimum of 30 min.

NOTE: In following operations, compressor will be on in heat pump prohibition zone.

- Other than heating
- Test run

● Auxiliary heater control by outdoor temperature 2

This control selects heat pump or external heater according to the outdoor temperature. Even when outdoor temperature is high, the heating is performed by using both of heat pump and external heater.

Operation			Condition
Heater on			Heater is on as shown in following diagram of heating temperature.
Heater off	DIP-SW101-3 Indoor unit fan setting for external heater	On Enabled	<ul style="list-style-type: none"> • Heater is off as shown in following diagram of heating temperature. • Other than heating mode • Error occurred • Forced thermostat off • Fan stop protection
	DIP-SW101-3 Indoor unit fan setting for external heater	Off Disabled	<ul style="list-style-type: none"> • Heater is off as shown in following diagram of heating temperature. • Other than heating mode • Error occurred • Forced thermostat off

- Temperature of heater on (Thon): Adjustable by function number 62 (Operating temperature switching of external heaters).
- All control temperatures will shift by adjusting “Thon”.
- Outdoor temperature zone boundary A: Adjustable by function setting number 66.

• External heater output

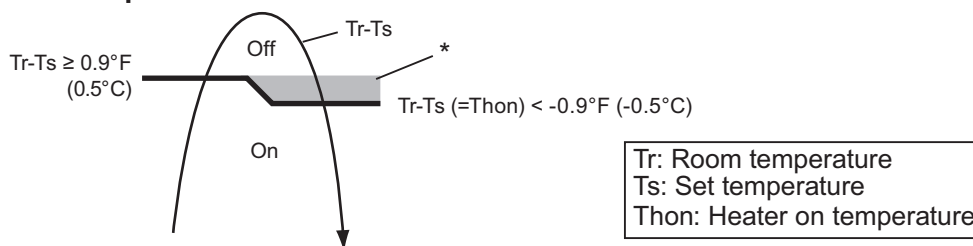

*: When room temperature stays in this zone for a specific time, auxiliary heater is turned on. For details, refer to function number 71.

• Outdoor temperature zone

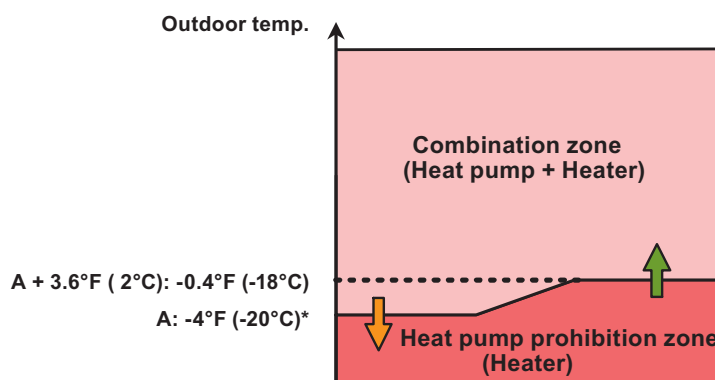

*: Adjustable by function setting 66

• Operation status

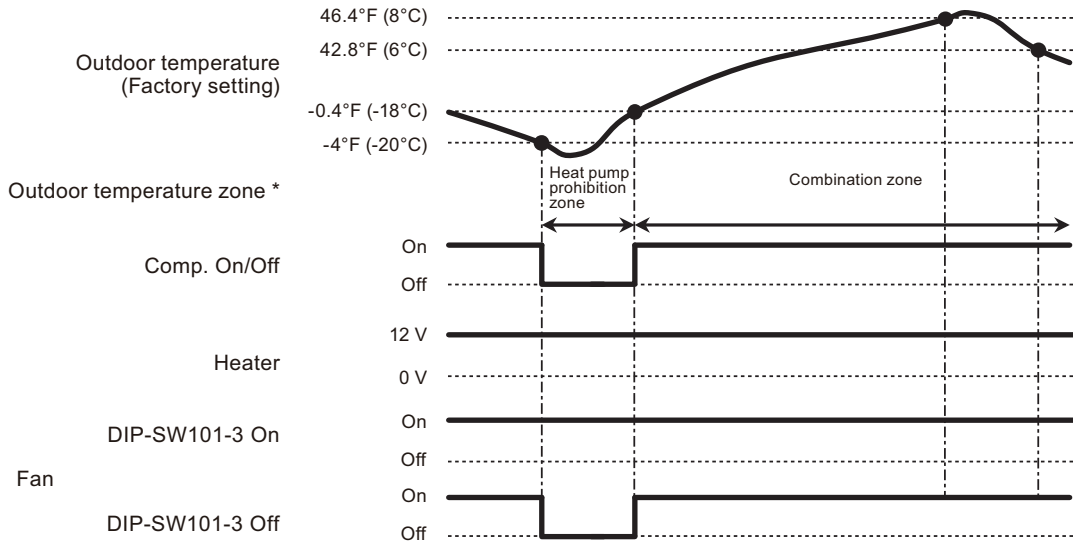

* The outdoor temperature zone transition from one to another will stay in that zone for minimum of 30 min.

NOTE: In following operations, compressor will be on in heat pump prohibition zone.

- Other than heating
- Test run

● Auxiliary heater control by outdoor temperature 3

This control selects heat pump or external heater according to the outdoor temperature. Even when outdoor temperature is high, the heating is performed by using both of heat pump and external heater.

Operation		Condition
Heater on		Heater is on as shown in following diagram of heating temperature.
Heater off	DIP-SW101-3 Indoor unit fan setting for external heater	On Enabled
	DIP-SW101-3 Indoor unit fan setting for external heater	Off Disabled

- Temperature of heater on (Thon): Adjustable by function number 62 (Operating temperature switching of external heaters).
- All control temperatures will shift by adjusting “Thon”.
- Outdoor temperature zone boundary B: Adjustable by function setting number 67.

• External heater output

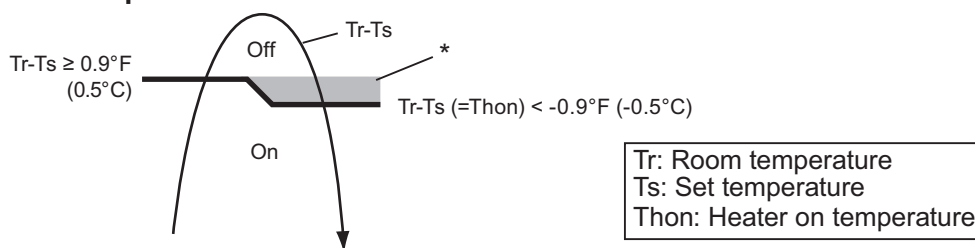

*: When room temperature stays in this zone for a specific time, auxiliary heater is turned on. For details, refer to function number 71.

• Outdoor temperature zone

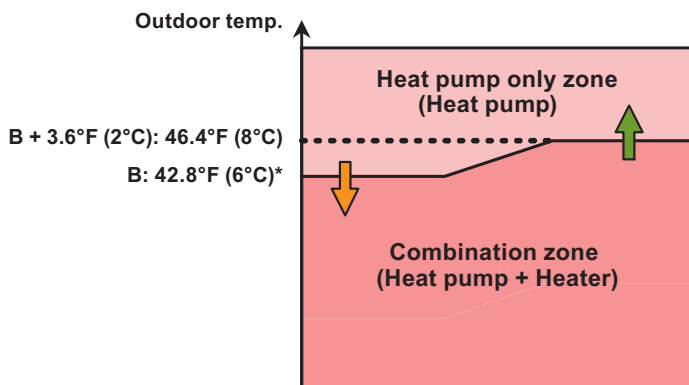

*: Adjustable by function setting 67

• Operation status

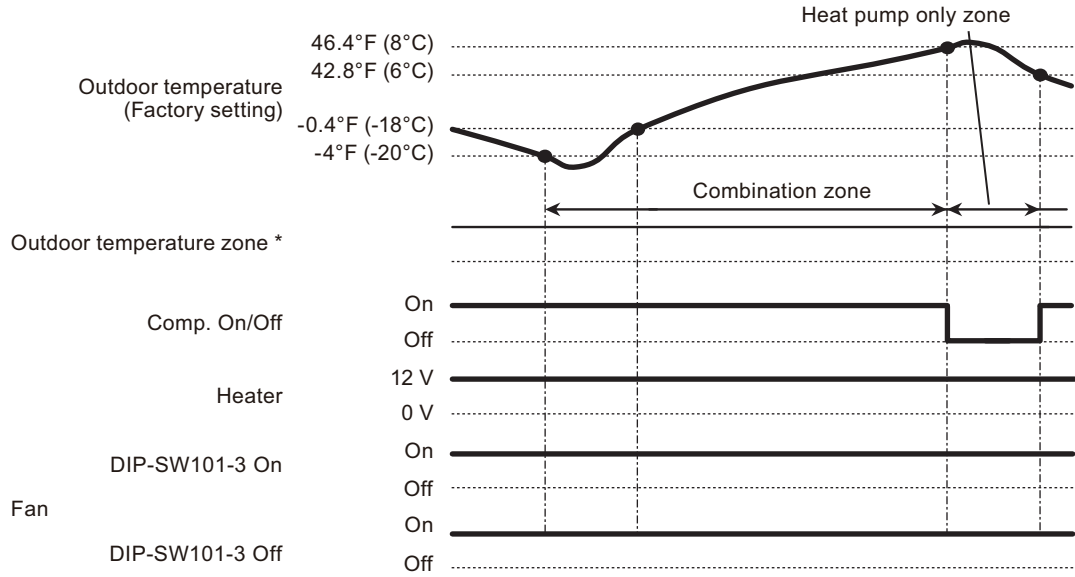

*: The outdoor temperature zone transition from one to another will stay in that zone for minimum of 30 min.

NOTE: In following operations, compressor will be on in heat pump prohibition zone.

- Other than heating
- Test run

● Auxiliary heat pump control

• External heater output

Operation			Condition
Heater on			Heater is on as shown in following diagram of heating temperature.
Heater off	DIP-SW101-3 Indoor unit fan setting for external heater	On Enabled	<ul style="list-style-type: none"> • Heater is off as shown in following diagram of heating temperature. • Other than heating mode • Error occurred • Forced thermostat off • Fan stop protection
	DIP-SW101-3 Indoor unit fan setting for external heater	Off Disabled	<ul style="list-style-type: none"> • Heater is off as shown in following diagram of heating temperature. • Other than heating mode • Error occurred • Forced thermostat off

- Temperature of heater on (Thon): Set temperature (Ts) - 0.9 °F (- 0.5 °C)
- Temperature of heater off: Set temperature (Ts) + 0.9 °F (+ 0.5 °C)

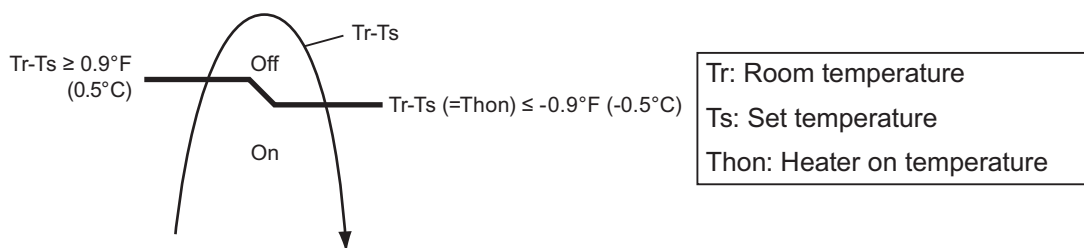

• Auxiliary heat pump On/Off

- Temperature of heater on (Thon): Adjustable by function number 62 (Operating temperature switching of heat pump).
- All control temperatures will shift by adjusting “Thon”.

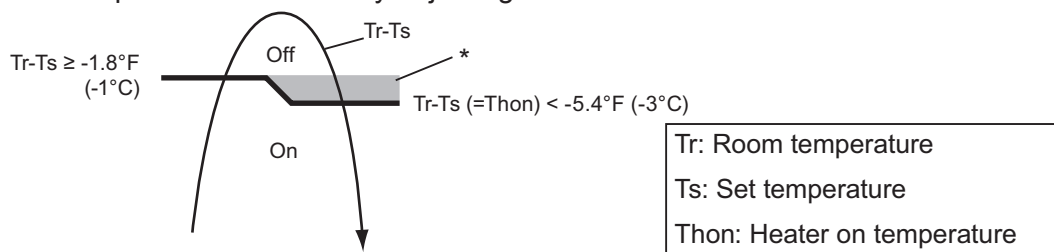

*: When room temperature stays in this zone for a specific time, auxiliary heater is turned on. For details, refer to function number 71.

● Auxiliary heat pump control by outdoor temperature 1

• External heater output

Operation		Condition
Heater on		Heater is on as shown in following diagram of heating temperature.
Heater off	DIP-SW101-3 On Indoor unit fan setting for external heater Enabled	<ul style="list-style-type: none"> • Heater is off as shown in following diagram of heating temperature. • Other than heating mode • Error occurred • Forced thermostat off • Fan stop protection
	DIP-SW101-3 Off Indoor unit fan setting for external heater Disabled	<ul style="list-style-type: none"> • Heater is off as shown in following diagram of heating temperature. • Other than heating mode • Error occurred • Forced thermostat off

- Temperature of heater on (Thon): Set temperature (Ts) - 0.9 °F (- 0.5 °C)
- Temperature of heater off: Set temperature (Ts) + 0.9 °F (+ 0.5 °C)

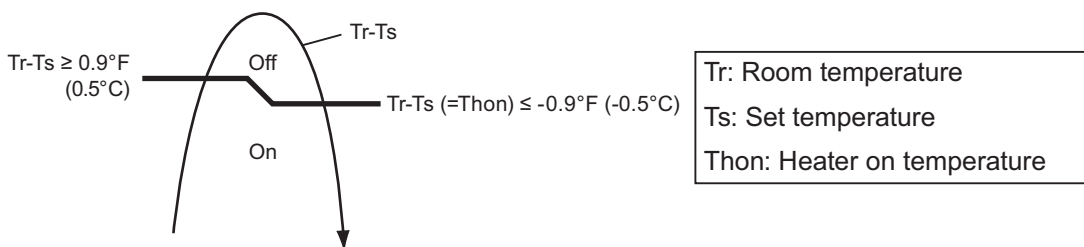

• Auxiliary heat pump On/Off

- Temperature of heater on (Thon): Adjustable by function number 62 (Operating temperature switching of heat pump).
- All control temperatures will shift by adjusting “Thon”.

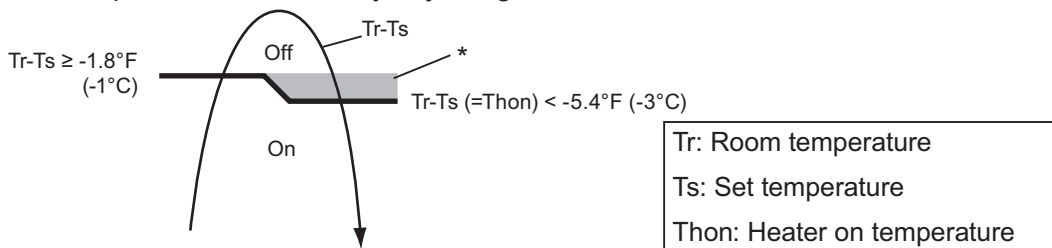

*: When room temperature stays in this zone for a specific time, auxiliary heater is turned on. For details, refer to function number 71.

• Outdoor temperature zone

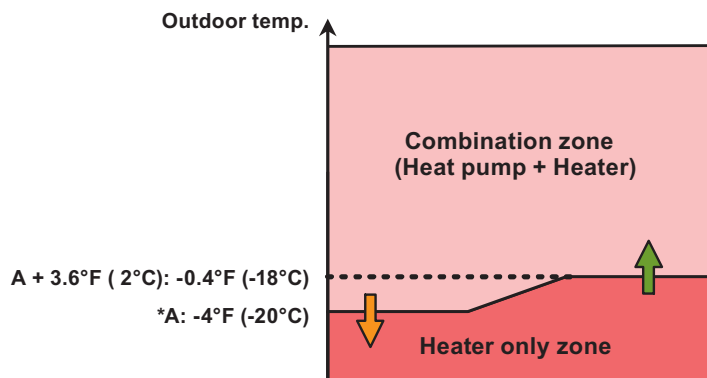

*: Adjustable by function setting 67

• Operation status

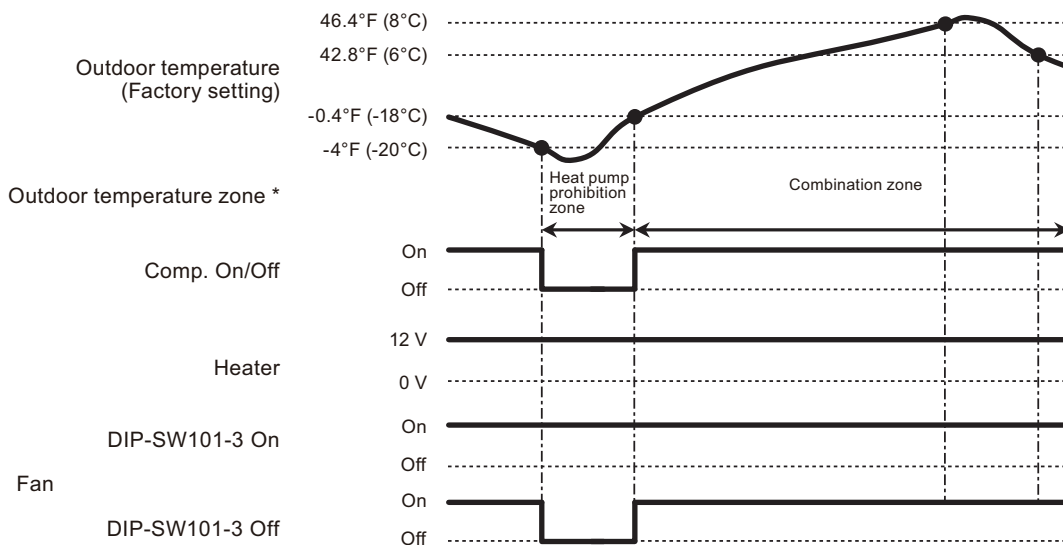

* The outdoor temperature zone transition from one to another will stay in that zone for minimum of 30 min.

NOTE: In following operations, compressor will be on in heat pump prohibition zone.

- Other than heating
- Test run

● Auxiliary heat pump control by outdoor temperature 2

• External heater output

Operation			Condition
Heater on			Heater is on as shown in following diagram of heating temperature.
Heater off	DIP-SW101-3 Indoor unit fan setting for external heater	On Enabled	<ul style="list-style-type: none"> • Heater is off as shown in following diagram of heating temperature. • Other than heating mode • Error occurred • Forced thermostat off • Fan stop protection
	DIP-SW101-3 Indoor unit fan setting for external heater	Off Disabled	<ul style="list-style-type: none"> • Heater is off as shown in following diagram of heating temperature. • Other than heating mode • Error occurred • Forced thermostat off

- Temperature of heater on (Thon): Set temperature (Ts) - 0.9 °F (- 0.5 °C)
- Temperature of heater off: Set temperature (Ts) + 0.9 °F (+ 0.5 °C)

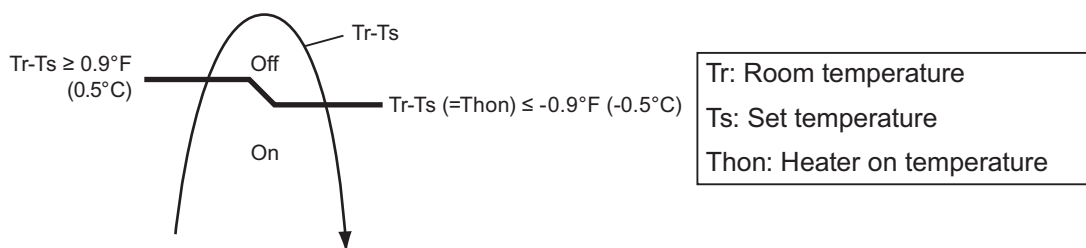

• Auxiliary heat pump On/Off

- Temperature of heater on (Thon): Adjustable by function number 62 (Operating temperature switching of heat pump).
- All control temperatures will shift by adjusting “Thon”.

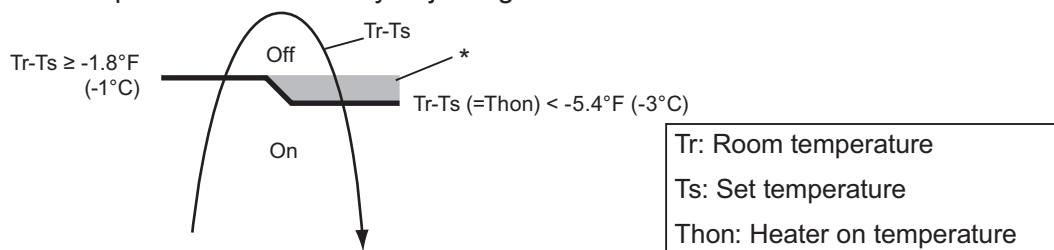

*: When room temperature stays in this zone for a specific time, auxiliary heater is turned on. For details, refer to function number 71.

• Outdoor temperature zone

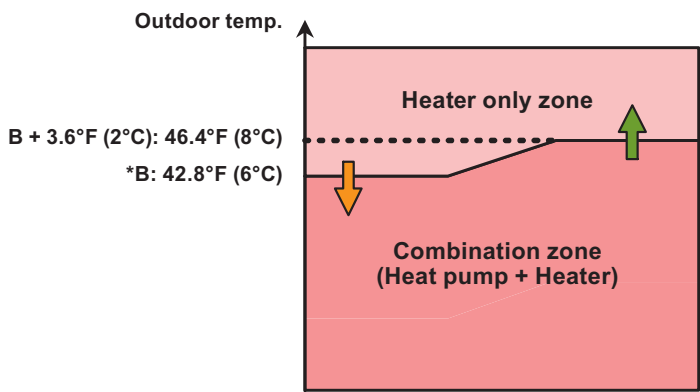

*: Adjustable by function setting 67

• Operation status

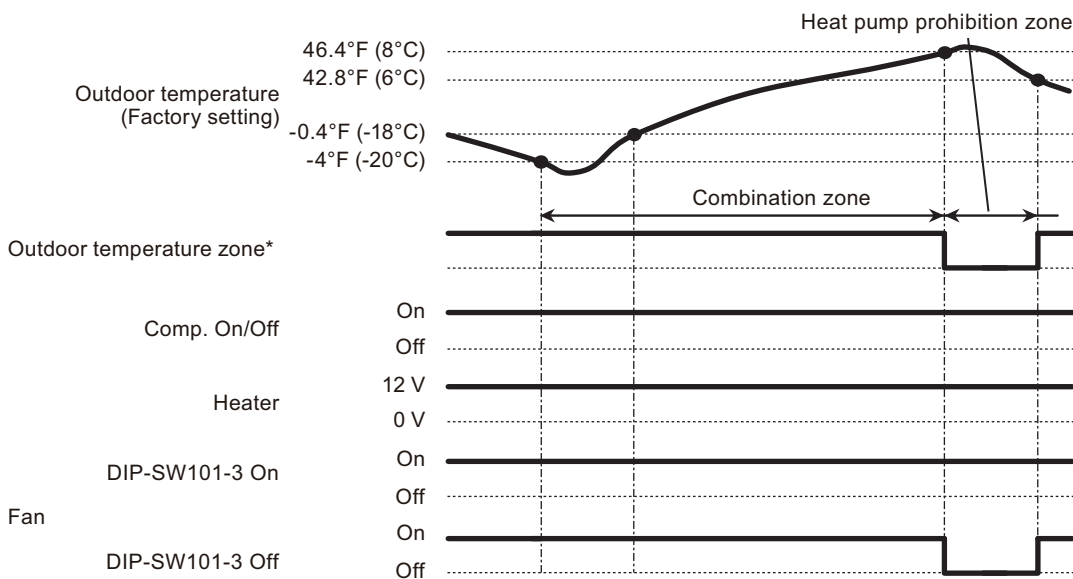

*: The outdoor temperature zone transition from one to another will stay in that zone for minimum of 30 min.

NOTE: In following operations, compressor will be on in heat pump prohibition zone.

- Other than heating
- Test run

● Auxiliary heat pump control by outdoor temperature 3

• External heater output

Operation			Condition
Heater on			Heater is on as shown in following diagram of heating temperature.
Heater off	DIP-SW101-3 Indoor unit fan setting for external heater	On Enabled	<ul style="list-style-type: none"> • Heater is off as shown in following diagram of heating temperature. • Other than heating mode • Error occurred • Forced thermostat off • Fan stop protection
	DIP-SW101-3 Indoor unit fan setting for external heater	Off Disabled	<ul style="list-style-type: none"> • Heater is off as shown in following diagram of heating temperature. • Other than heating mode • Error occurred • Forced thermostat off

- Temperature of heater on (Thon): Set temperature (Ts) - 0.9 °F (- 0.5 °C)
- Temperature of heater off: Set temperature (Ts) + 0.9 °F (+ 0.5 °C)

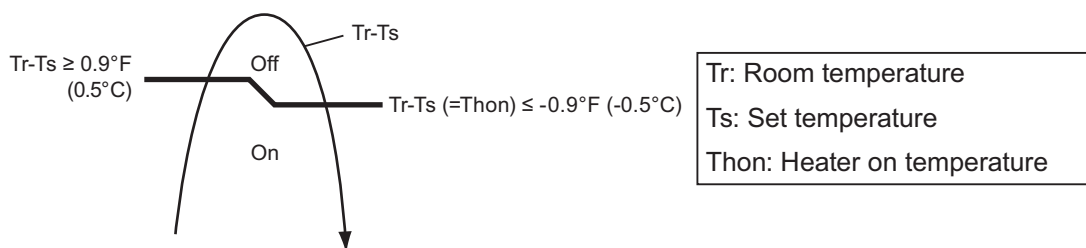

• Auxiliary heat pump On/Off

- Temperature of heater on (Thon): Adjustable by function number 62 (Operating temperature switching of heat pump).
- All control temperatures will shift by adjusting “Thon”.

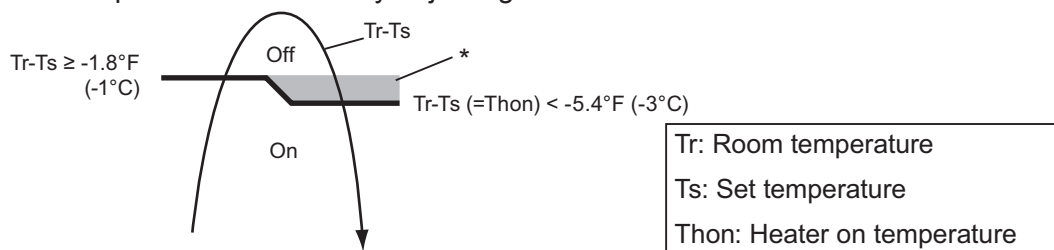

*: When room temperature stays in this zone for a specific time, auxiliary heater is turned on. For details, refer to function number 71.

• Outdoor temperature zone

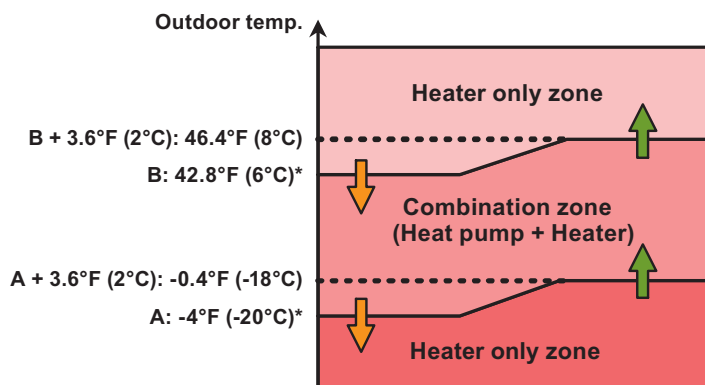

*: Adjustable by function setting 66 and 67

• Operation status

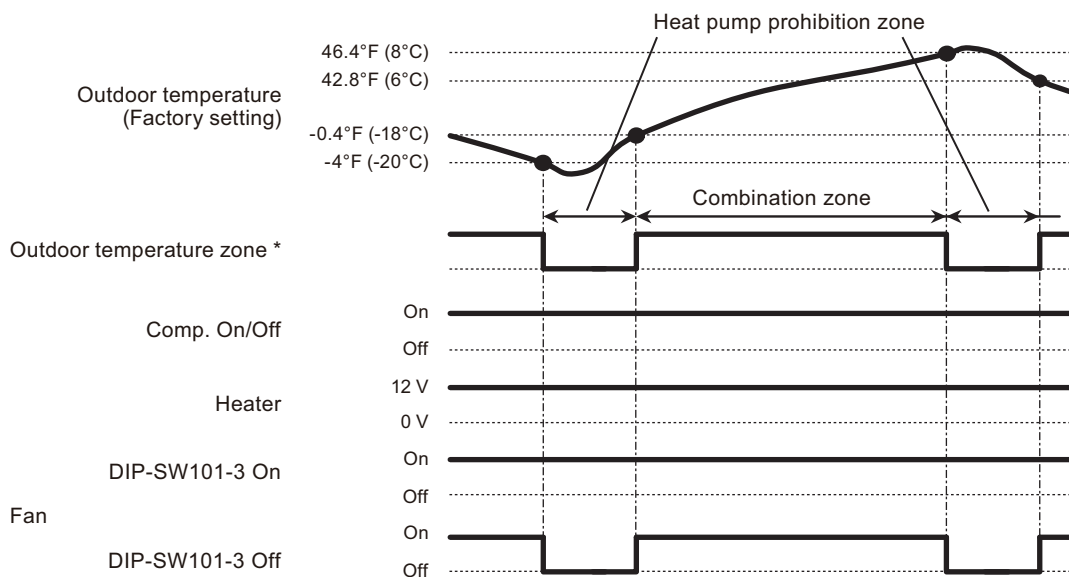

* The outdoor temperature zone transition from one to another will stay in that zone for minimum of 30 min.

NOTE: In following operations, compressor will be on in heat pump prohibition zone.

- Other than heating
- Test run

■ Heating thermostat on for humidifier

Situation	Indoor unit				
	Mode	Function setting	Rotary SW	External output	
		Heating thermostat on no. 60		Heating thermostat on	Indoor unit fan operation status
Example of individual connection	5	60-05	7	CN47	Not used
	6	60-06	8	Output3	
	7	60-07	9	Output2	
	8	60-08	A	Output1	

- Example of individual connection

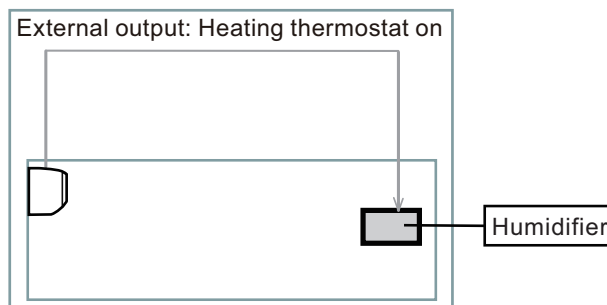

- Operation status

The heating thermostat output for CN47, Output1, Output2, and Output3 will be on when comp on or external heater on.

The heating thermostat output will be off when comp off and external heater off.

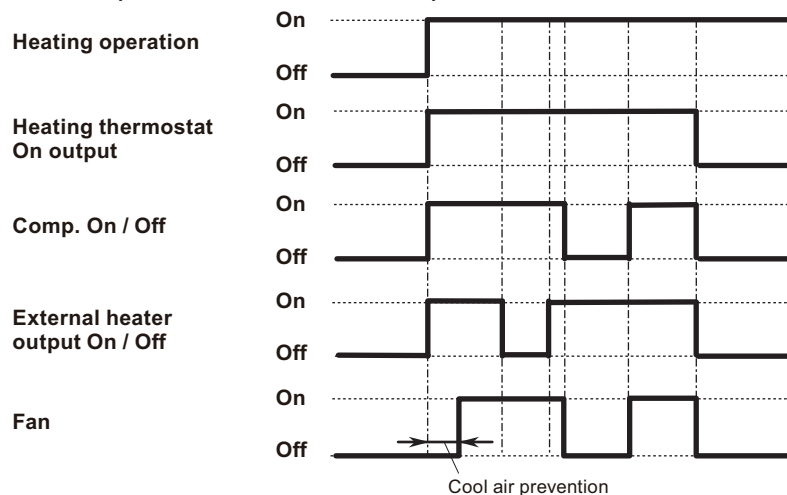

9. Function settings

To adjust the functions of this product according to the installation environment, various types of function settings are available.

NOTE: Incorrect settings can cause a product malfunction.

9-1. Function settings on indoor unit

■ Models: ARU12RGLX, ARU18RGLX, ARU24RGLX, ARU30RGLX, ARU36RGLX, ARU42RGLX, and ARU48RGLX

By using some components on the PCB, you can change the function settings.

Related components on the PCB and the applicable settings

Component		Setting content
DIP switch100	1	Remote controller address setting
	2	
	3	
	4	
DIP switch101	1	Setting change prohibited
	2	Setting change prohibited
	3	Fan delay setting

● Component location

Components on the indoor unit main PCB used for the function settings are located as shown in the following figure.

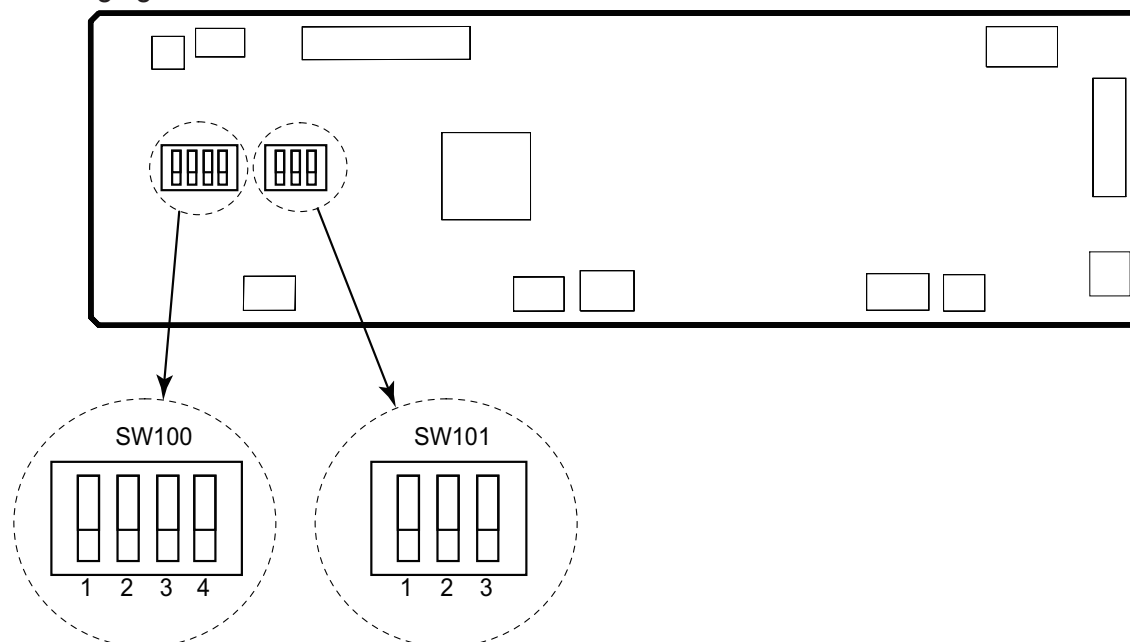

● DIP switch setting

- **Remote controller address setting (SW100)**

When operating a number of indoor units by using a wired remote controller, DIP switch setting for assigning unit number to each indoor unit is required.

DIP switches are normally set to make the unit number 00.

Remote controller address	DIP switch number				Factory setting
	1	2	3	4	
00	OFF	OFF	OFF	OFF	◆
01	ON	OFF	OFF	OFF	
02	OFF	ON	OFF	OFF	
03	ON	ON	OFF	OFF	
04	OFF	OFF	ON	OFF	
05	ON	OFF	ON	OFF	
06	OFF	ON	ON	OFF	
07	ON	ON	ON	OFF	
08	OFF	OFF	OFF	ON	
09	ON	OFF	OFF	ON	
10	OFF	ON	OFF	ON	
11	ON	ON	OFF	ON	
12	OFF	OFF	ON	ON	
13	ON	OFF	ON	ON	
14	OFF	ON	ON	ON	
15	ON	ON	ON	ON	

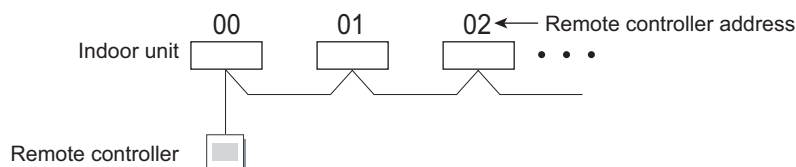

- **Switch 1: Setting change prohibited (SW101)**
- **Switch 2: Setting change prohibited (SW101)**
- **Switch 3: Fan delay setting (SW101)**

When the indoor unit is stopped while operating in conjunction with auxiliary heater, the indoor unit fan operation will continue for 1 minute.

Switch 3	Fan delay	Factory setting
ON	Enabled	
OFF	Disabled	◆

9-2. Function settings by using remote controller

Some function settings can be changed on the remote controller. After confirming the setting procedure and the content of each function setting, select appropriate functions for your installation environment.

■ Setting procedure by using remote controller

Remote controller is not attached for this product. For details of the installing remote controller, refer to following information.

- Overview information: Operating manual of the remote controller
- Setting procedure: Installation manual of the remote controller

■ Contents of function setting

Each function setting listed in this section is adjustable in accordance with the installation environment.

NOTE: Setting will not be changed if invalid numbers or setting values are selected.

● Function setting list

	Function no.	Functions
1)	11	Filter sign
2)	26	Static pressure
3)	30/31	Room temperature control for indoor unit sensor
4)	35/36	Room temperature control for wired remote controller sensor
5)	40	Auto restart
6)	42	Room temperature sensor switching
7)	43	Cold air prevention
8)	44	Remote controller custom code
9)	46	External input control
10)	48	Room temperature sensor switching (Aux.)
11)	49	Indoor unit fan control for energy saving for cooling
12)	60	Switching functions for external output terminal
13)	61	Control switching of external heaters
14)	62	Operating temperature switching of external heaters
15)	66	Outdoor temperature zone boundary temperature A
16)	67	Outdoor temperature zone boundary temperature B
17)	71	Standby time for auxiliary equipment operation
18)	73	Emergency heat
19)	74	Fan delay time
20)	75	External heater use in defrosting

1) Filter sign

Select appropriate intervals for displaying the filter sign on the indoor unit according to the estimated amount of dust in the air of the room.

If the indication is not required, select "No indication" (03).

Function number	Setting value	Setting description	Factory setting
11	00	Standard (2,500 hours)	
	01	Long interval (4,400 hours)	
	02	Short interval (1,250 hours)	
	03	No indication	◆

2) Static pressure

Select the appropriate static pressure according to the installation conditions.

Function number	Setting value	Setting description	Factory setting
26	03	0.12 inWG (30 Pa)	
	04	0.16 inWG (40 Pa)	
	05	0.20 inWG (50 Pa)	
	06	0.24 inWG (60 Pa)	
	07	0.28 inWG (70 Pa)	
	08	0.32 inWG (80 Pa)	
	09	0.36 inWG (90 Pa)	
	10	0.40 inWG (100 Pa)	
	11	0.44 inWG (110 Pa)	
	12	0.48 inWG (120 Pa)	
	13	0.52 inWG (130 Pa)	
	14	0.56 inWG (140 Pa)	
	15	0.60 inWG (150 Pa)	
	16	0.64 inWG (160 Pa)	
	17	0.68 inWG (170 Pa)	
	18	0.72 inWG (180 Pa)	
	19	0.76 inWG (190 Pa)	
	20	0.80 inWG (200 Pa)	
	31	Standard 12/18/24 model: 0.18 inWG (45 Pa) 30/36/42 model: 0.23 inWG (57 Pa) 48 model: 0.28 inWG (70 Pa)	◆
	32	Automatic airflow adjustment	

NOTE: Range of static pressure is different by model.

Model name	Range of static pressure
12//18/24/30/36 model	0.12 to 0.8 inWG (30 to 200 Pa)
42/48 model	0.12 to 0.72 inWG (30 to 180 Pa)

3) Room temperature control for indoor unit sensor

Depending on the installed environment, correction of the room temperature sensor may be required. Select the appropriate control setting according to the installed environment.

The temperature correction values show the difference from the Standard setting "00" (manufacturer's recommended value).

Function number		Setting value	Setting description	Factory setting	
30 (For cooling)	31 (For heating)	00	Standard setting	◆	
		01	No correction 0.0 °F (0.0 °C)		
		02	-1 °F (-0.5 °C)	More cooling Less heating	
		03	-2 °F (-1.0 °C)		
		04	-3 °F (-1.5 °C)		
		05	-4 °F (-2.0 °C)		
		06	-5 °F (-2.5 °C)		
		07	-6 °F (-3.0 °C)		
		08	-7 °F (-3.5 °C)		
		09	-8 °F (-4.0 °C)		
		10	+1 °F (+0.5 °C)	Less cooling More heating	
		11	+2 °F (+1.0 °C)		
		12	+3 °F (+1.5 °C)		
		13	+4 °F (+2.0 °C)		
		14	+5 °F (+2.5 °C)		
		15	+6 °F (+3.0 °C)		
		16	+7 °F (+3.5 °C)		
17	+8 °F (+4.0 °C)				

4) Room temperature control for wired remote controller sensor

Depending on the installed environment, correction of the wire remote temperature sensor may be required. Select the appropriate control setting according to the installed environment.

To change this setting, set Function 42 to Both "01".

Ensure that the Thermo Sensor icon is displayed on the remote controller screen.

Function number		Setting value	Setting description	Factory setting	
35 (For cooling)	36 (For heating)	00	Standard setting	◆	
		01	No correction 0.0 °F (0.0 °C)		
		02	-1 °F (-0.5 °C)	More cooling Less heating	
		03	-2 °F (-1.0 °C)		
		04	-3 °F (-1.5 °C)		
		05	-4 °F (-2.0 °C)		
		06	-5 °F (-2.5 °C)		
		07	-6 °F (-3.0 °C)		
		08	-7 °F (-3.5 °C)		
		09	-8 °F (-4.0 °C)		
		10	+1 °F (+0.5 °C)	Less cooling More heating	
		11	+2 °F (+1.0 °C)		
		12	+3 °F (+1.5 °C)		
		13	+4 °F (+2.0 °C)		
		14	+5 °F (+2.5 °C)		
		15	+6 °F (+3.0 °C)		
		16	+7 °F (+3.5 °C)		
17	+8 °F (+4.0 °C)				

5) Auto restart

Enables or disables automatic restart after a power interruption.

Function number	Setting value	Setting description	Factory setting
40	00	Enable	◆
	01	Disable	

NOTE: Auto restart is an emergency function such as for power outage etc. Do not attempt to use this function in normal operation. Be sure to operate the unit by remote controller or external device.

6) Room temperature sensor switching

When using the wired remote controller temperature sensor, change the setting to "Both" (01).

Function number	Setting value	Setting description	Factory setting
42	00	Indoor unit	◆
	01	Both	

00: Sensor on the indoor unit is active.

01: Sensors on both indoor unit and wired remote controller are active.

NOTE: Remote controller sensor must be turned on by using the remote controller.

7) Cold air prevention

This setting is to disable the cold air prevention function during heating operation. When disabled, the fan setting will always follow the setting on the remote controller. (Excluding defrost mode)

Function number	Setting value	Setting description	Factory setting
43	00	Enable	◆
	01	Disable	

8) Remote controller custom code

(Only for wireless remote controller)

The indoor unit custom code can be changed. Select the appropriate custom code.

Function number	Setting value	Setting description	Factory setting
44	00	A	◆
	01	B	
	02	C	
	03	D	

9) External input control

"Operation/Stop" mode or "Forced stop" mode can be selected.

Function number	Setting value	Setting description	Factory setting
46	00	Operation/Stop mode 1	◆
	01	(Setting prohibited)	
	02	Forced stop mode	
	03	Operation/Stop mode 2	

10) Room temperature sensor switching (Aux.)

To use the temperature sensor on the wired remote controller only, change the setting to "Wired remote controller" (01).

This function will only work if the function setting 42 is set at "Both" (01).

When the setting value is set to "Both" (00), more suitable control of the room temperature is possible by setting function setting 30 and 31 too.

Function number	Setting value	Setting description	Factory setting
48	00	Both	◆
	01	Wired remote controller	

11) Indoor unit fan control for energy saving for cooling

Enables or disables the power-saving function by controlling the indoor unit fan rotation when the outdoor unit is stopped during cooling operation.

Function number	Setting value	Setting description	Factory setting
49	00	Disable	◆
	01	Enable	
	02	Remote controller	

00: When the outdoor unit is stopped, the indoor unit fan operates continuously following the setting on the remote controller.

01: When the outdoor unit is stopped, the indoor unit fan operates intermittently at a very low speed.

02: Enable or disable this function by remote controller setting.

NOTES:

- As the factory setting, this setting is initially invalidated.
- Set to "00" or "01" when connecting a remote controller that cannot set the Fan control for energy saving function or connecting a network converter.
To confirm if the remote controller has this setting, refer to the operating manual of each remote controller.

12) Switching functions for external output terminal

Functions of the external output terminal can be switched. For details, refer to "External input and output".

Function number	Setting value	Setting description	Factory setting
60	00	Operation status	◆
	01—04	Cooling thermostat On	
	05	Heating operation	
	06	Operation/Stop	
	07—08	Cooling thermostat On	
	09	Error status	
	10	Indoor unit fan operation status	
	11	External heater	

13) Control switching of external heaters

Sets the control method for external heater to be used.

For details, refer to Chapter 8-4. "[Details of function](#)" on page 58

Function number	Setting value	Setting description	Factory setting
61	00	Auxiliary heater control 1	◆
	01	Auxiliary heater control 2	
	02	Heat pump prohibition control	
	03	Auxiliary heater control by outdoor temperature 1	
	04	Auxiliary heater control by outdoor temperature 2	
	05	Auxiliary heater control by outdoor temperature 3	
	06	Auxiliary heat pump control	
	07	Auxiliary heat pump control by outdoor temperature 1	
	08	Auxiliary heat pump control by outdoor temperature 2	
	09	Auxiliary heat pump control by outdoor temperature 3	

14) Operating temperature switching of external heaters

Sets the temperature conditions when the external heater is ON.

For details, refer to Chapter 8-4. "[Details of function](#)" on page 58.

Function number	Setting value	Setting description				Factory setting
		Setting value of function 61:				
		00		01 to 09		
		Heater: On	Heater: Off	Heater: On	Heater: Off	
62	00	-5.4 °F (-3 °C)	-1.8 °F (-1 °C)	-0.9 °F (-0.5 °C)	0.9 °F (0.5 °C)	◆
	01	-3.6 °F (-2 °C)	-1.8 °F (-1 °C)	-1.8 °F (-1 °C)	0.9 °F (0.5 °C)	
	02	-3.6 °F (-2 °C)	-1.8 °F (-1 °C)	-3.6 °F (-2 °C)	0.9 °F (0.5 °C)	
	03	-5.4 °F (-3 °C)	-1.8 °F (-1 °C)	-5.4 °F (-3 °C)	0.9 °F (0.5 °C)	
	04	-7.2 °F (-4 °C)	-1.8 °F (-1 °C)	-7.2 °F (-4 °C)	0.9 °F (0.5 °C)	
	05	-9.0 °F (-5 °C)	-1.8 °F (-1 °C)	-9.0 °F (-5 °C)	0.9 °F (0.5 °C)	
	06	-5.4 °F (-3 °C)	-0.9 °F (-0.5 °C)	-0.9 °F (-0.5 °C)	0 °F (0 °C)	
	07	-3.6 °F (-2 °C)	-0.9 °F (-0.5 °C)	-1.8 °F (-1 °C)	0 °F (0 °C)	
	08	-3.6 °F (-2 °C)	-0.9 °F (-0.5 °C)	-3.6 °F (-2 °C)	0 °F (0 °C)	
	09	-5.4 °F (-3 °C)	-0.9 °F (-0.5 °C)	-5.4 °F (-3 °C)	0 °F (0 °C)	
	10	-7.2 °F (-4 °C)	-0.9 °F (-0.5 °C)	-7.2 °F (-4 °C)	0 °F (0 °C)	
	11	-9.0 °F (-5 °C)	-0.9 °F (-0.5 °C)	-9.0 °F (-5 °C)	0 °F (0 °C)	
	12	-5.4 °F (-3 °C)	0 °F (0 °C)	-0.9 °F (-0.5 °C)	-0.9 °F (-0.5 °C)	
	13	-3.6 °F (-2 °C)	0 °F (0 °C)	-1.8 °F (-1 °C)	-0.9 °F (-0.5 °C)	
	14	-3.6 °F (-2 °C)	0 °F (0 °C)	-3.6 °F (-2 °C)	-0.9 °F (-0.5 °C)	
	15	-5.4 °F (-3 °C)	0 °F (0 °C)	-5.4 °F (-3 °C)	-0.9 °F (-0.5 °C)	
	16	-7.2 °F (-4 °C)	0 °F (0 °C)	-7.2 °F (-4 °C)	-0.9 °F (-0.5 °C)	
17	-9.0 °F (-5 °C)	0 °F (0 °C)	-9.0 °F (-5 °C)	-0.9 °F (-0.5 °C)		

15) Outdoor temperature zone boundary temperature A

Setting required if changing of the outdoor temperature setting for heat pump prohibition zone is required when auxiliary heater control by outdoor temperature 1 and 2 are performed on the indoor unit. For details, refer to Chapter 8-4. "[Details of function](#)" on page 58.

Function number	Setting value	Setting description	Factory setting
66	00	-4.0 °F (-20 °C)	◆
	01	-0.4 °F (-18 °C)	
	02	3.2 °F (-16 °C)	
	03	6.8 °F (-14 °C)	
	04	10.4 °F (-12 °C)	
	05	14.0 °F (-10 °C)	
	06	17.6 °F (-8 °C)	
	07	21.2 °F (-6 °C)	
	08	24.8 °F (-4 °C)	

16) Outdoor temperature zone boundary temperature B

Setting required if changing of the outdoor temperature setting for heat pump only zone is required when auxiliary heater control by outdoor temperature 1 is performed on the indoor unit. For details, refer to Chapter 8-4. "[Details of function](#)" on page 58.

Function number	Setting value	Setting description	Factory setting
67	00	42.8 °F (6 °C)	◆
	01	14.0 °F (-10 °C)	
	02	17.6 °F (-8 °C)	
	03	21.2 °F (-6 °C)	
	04	24.8 °F (-4 °C)	
	05	28.4 °F (-2 °C)	
	06	32.0 °F (0 °C)	
	07	35.6 °F (2 °C)	
	08	39.2 °F (4 °C)	
	09	42.8 °F (6 °C)	
	10	46.4 °F (8 °C)	
	11	50.0 °F (10 °C)	
	12	53.6 °F (12 °C)	
	13	57.2 °F (14 °C)	
	14	60.8 °F (16 °C)	
15	64.4 °F (18 °C)		

17) Standby time for auxiliary equipment operation

Sets the standby time until the auxiliary equipment operation starts during primary equipment operation.

For details, refer to Chapter 8-4. "[Details of function](#)" on page 58

Function number	Setting value	Setting description	Factory setting
71	00	Disable	◆
	01	1 minute	
	02	2 minutes	
	•	•	
	•	•	
	•	•	
	98	98 minutes	
	99	99 minutes	

18) Emergency heat

Enables or disables emergency heat input.

Function number	Setting value	Setting description	Factory setting
73	00	Disable	◆
	01	Enable	

NOTE: When this function is used, IR receiver unit is necessary.

19) Fan delay time

Sets the fan delay time when the heater is turned off.

Function number	Setting value	Setting description	Factory setting
74	00	1 minute	◆
	01	50 seconds	
	02	40 seconds	
	03	30 seconds	









20) External heater use in defrosting

Enables or disables external heater use in defrosting.

NOTE: Inappropriate heater selection may cause cold air in defrosting.

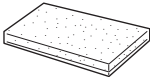
Function number	Setting value	Setting description	Factory setting
75	00	Disable	◆
	01	Enable	

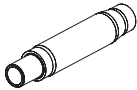
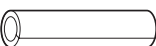
10. Accessories

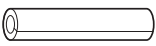
Part name	Exterior	Q'ty	Part name	Exterior	Q'ty
Operating manual		1	Cable tie (large)		4
Installation manual (indoor unit)		1	Cable tie (medium)		1
Special nut A (large flange)		4	Cable tie (small)		1
Special nut B (small flange)		4	Drain hose insulation		1
Washer		8	Drain hose		1
Coupler heat insulation (large)		1	Hose band		1
Coupler heat insulation (small)		1			



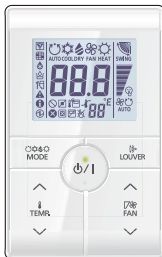
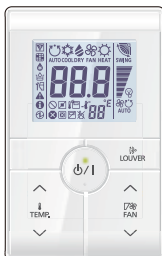
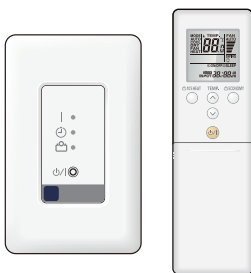

11. Optional parts

11-1. Controllers

Exterior	Part name	Model name	Summary
	Wired remote controller	UTY-RNRUZ*	Easy finger touch operation with LCD panel. Backlit LCD enables easy operation in a dark room. Wire type: Non-polar 2-wire
	Simple remote controller	UTY-RSRY	Compact remote controller concentrates on the basic functions such as Start/Stop, fan control, temperature setting, and operation mode. Wire type: Non-polar 2-wire
	Simple remote controller	UTY-RHRY	Compact remote controller concentrates on the basic functions such as Start/Stop, fan control, and temperature setting. Wire type: Non-polar 2-wire
	IR receiver kit with wireless remote controller	UTY-LBTUM	Unit control is performed by wireless remote controller.

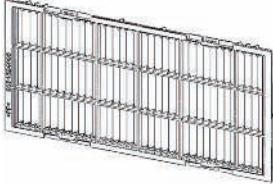
NOTE: Available functions may differ by the remote controller. For details, refer to the operation manual.

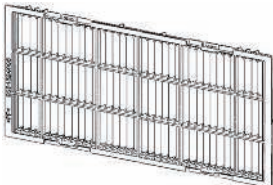
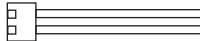
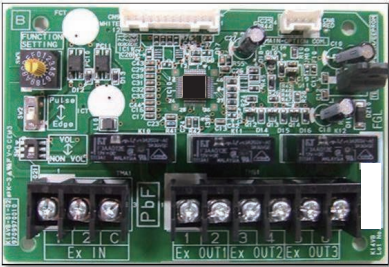
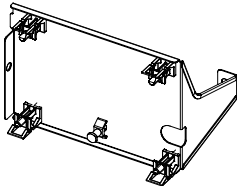
11-2. Others

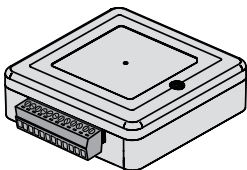
Exterior	Part name	Model name	Summary
	Remote sensor unit	UTY-XSZX	Thermo-sensor for sensing the temperature of arbitrary place in the room.
	Long-life filter	UTD-LFNC	Long-life filter can be mounted to the indoor unit. (For 12 model)
	Long-life filter	UTD-LFNB	Long-life filter can be mounted to the indoor unit. (For 18, 24, and 30 models)
	Long-life filter	UTD-LFNA	Long-life filter can be mounted to the indoor unit. (For 36, 42, and 48 models)
	External connect kit	UTY-XWZXZG	Use to connect with various peripheral devices and air conditioner PCB. For control output port.
	External input and output PCB	UTY-XCSX	Use to connect with external devices and air conditioner PCB.
	External input and output PCB bracket	UTZ-GXNA	For installing the External input and output PCB.
	Wireless LAN adapter	UTY-TFSXZ2	Remotely manage an air conditioning system using mobile devices such as smartphones and tablets. For connection indoor unit with UART interface.
	Thermostat converter	UTY-TTRX	This converter can control Fujitsu General products using a third-party thermostat controller.

NOTE: Combined use of following optional parts and Wireless LAN adapter (UTY-TFSXZ2) is not allowed.

- External input and output PCB (UTY-XCSX)
- Thermostat converter

Part 2. OUTDOOR UNIT

SINGLE TYPE:

AOU12RLFC

AOU18RGLX

AOU24RGLX

AOU30RGLX

AOU36RGLX

AOU42RGLX

AOU48RGLX

1. Specifications

Type				Inverter heat pump	
Model name				AOU12RLFC	
Power supply				208/230 V ~ 60 Hz	
Power supply intake				Outdoor unit	
Available voltage range				187—253 V	
Starting current				6.7	
Fan	Airflow rate	Cooling	CFM (m ³ /h)	1,207 (2,050)	
		Heating		1,083 (1,840)	
	Type × Q'ty	Propeller × 1			
Motor output			W	49	
Sound pressure level *	Cooling		dB (A)	49	
	Heating			50	
Heat exchanger type	Dimensions (H × W × D)		in (mm)	23-5/32 × 34-11/16 × 1-7/16 (588 × 881 × 36.4)	
	Fin pitch			FPI	20
	Rows × Stages		2 × 28		
	Pipe type		Copper		
	Fin	Type (Material)		Aluminum	
		Surface treatment		PC fin	
Compressor	Type × Q'ty			Rotary × 1	
	Motor output			W	850
Refrigerant	Type			R410A	
	Factory charge			lb (g)	2 lb 10 oz (1,200)
Refrigerant oil	Type			FREOL α68SZ	
	Amount			in ³ (cm ³)	21.4 (350)
Enclosure	Material			Steel	
	Color			Beige Approximate color of Munsell 10YR 7.5/1.0	
Dimensions (H × W × D)	Net		in (mm)	24-1/2 × 31-3/32 × 11-11/32 (620 × 790 × 290)	
	Gross			28-1/16 × 37-7/32 × 15-9/16 (713 × 945 × 395)	
Weight	Net		lb (kg)	84 (38)	
	Gross			93 (42)	
Connection pipe	Size	Liquid	in (mm)	Ø1/4 (6.35)	
		Gas		Ø3/8 (9.52)	
	Method			Flare	
	Pre-charge length			49 (15)	
	Max. length			66 (20)	
	Max. height difference			49 (15)	
Operation range	Cooling		°F (°C)	14 to 115 (-10 to 46)	
	Heating			-4 to 75 (-20 to 24)	
Drain hose	Material			LDPE	
	Size			in (mm)	Ø1/2 (Ø13.0) [I.D.], Ø5/8 to Ø11/16 (Ø16.0 to Ø16.7) [O.D.]
NOTES:					
<ul style="list-style-type: none"> • Specifications are based on the following conditions: <ul style="list-style-type: none"> – Cooling: Indoor temperature of 80 °FDB/67 °FWB(26.67 °CDB/19.44 °CWB), and outdoor temperature of 95 °FDB/75 °FWB (35 °CDB/23.9 °CWB). – Heating: Indoor temperature of 70 °FDB/59 °FWB (21.11 °CDB/15 °CWB), and outdoor temperature of 47 °FDB /43 °FWB (8.33 °CDB/6.11 °CWB). – Pipe length: 24 ft 7 in (7.5 m), Height difference: 0 m. (Between outdoor unit and indoor unit.) • Protective function might work when using it outside the operation range. • *: Sound pressure level <ul style="list-style-type: none"> – Measured values in manufacturer's anechoic chamber. – Because of the surrounding sound environment, the sound levels measured in actual installation conditions might be higher than the specified values here. 					

Type			Inverter heat pump				
Model name			AOU18RGLX	AOU24RGLX	AOU30RGLX	AOU36RGLX	
Power supply			208/230 V ~ 60 Hz				
Power supply intake			Outdoor unit				
Available voltage range			187—253 V				
Starting current			A	6.6	9.6	11.5	16.1
Fan	Airflow rate	Cooling	CFM (m ³ /h)	1,177 (2,000)	2,119 (3,600)	2,119 (3,600)	2,237 (3,800)
		Heating		1,489 (2,530)	2,119 (3,600)	2,119 (3,600)	2,237 (3,800)
	Type × Q'ty	Propeller × 1					
Motor output			W	100			
Sound pressure level *	Cooling		dB (A)	47	55	53	54
	Heating			50	56	55	56
Heat exchanger type	Dimensions (H × W × D)		in	31-7/16 × 35-7/16 × 1-7/16			
			mm	798 × 900 × 36.4			
	Fin pitch		FPI	20			
	Rows × Stages		2 × 38				
	Pipe type		Copper				
	Fin		Type (Material)	Aluminum			
		Surface treatment	PC Fin				
Compressor	Type × Q'ty		Rotary × 1				
	Motor output		W	2,100			
Refrigerant	Type		R410A				
	Charge	lb oz	4 lb 10.1 oz				
		g	2,100				
Refrigerant oil	Type		POE (RB68)				
	Amount		in ³ (cm ³)	48.8 (800)			
Enclosure	Material		Steel				
	Color		Beige Approximate color of Munsell 10YR 7.5/1.0				
Dimensions (H × W × D)	Net		in (mm)	32-11/16 × 35-7/16 × 13 (830 × 900 × 330)			
	Gross		in (mm)	39-3/8 × 41-5/16 × 17-1/2 (1,000 × 1,050 × 445)			
Weight	Net		lb (kg)	134 (61)			
	Gross			152 (69)			
Connection pipe	Size	Liquid	in (mm)	Ø1/4 (6.35)	Ø3/8 (9.52)		
		Gas		Ø1/2 (12.70)	Ø5/8 (15.88)		
	Method		Flare				
	Pre-charge length		ft (m)	65 (20)			
	Max. length			164 (50)			
Max. height difference		98 (30)					
Operation range	Cooling		°F (°C)	-4 to 115 (-20 to 46)			
	Heating			-4 to 75 (-20 to 24)			
Drain hose	Material		LDPE				
	Size		in (mm)	Ø1/2 (13.0) [I.D.], Ø5/8 to Ø11/16 (16.0 to 16.7) [O.D.]			
NOTES:							
<ul style="list-style-type: none"> Specifications are based on the following conditions: <ul style="list-style-type: none"> Cooling: Indoor temperature of 80 °FDB (26.67 °CDB) / 67 °FWB (19.44 °CWB), and outdoor temperature of 95 °FDB (35 °CDB) / 75 °FWB (23.9 °CWB). Heating: Indoor temperature of 70 °FDB (21.11 °CDB) / 59 °FWB (15 °CWB), and outdoor temperature of 47 °FDB (8.33 °CDB) / 43 °FWB (6.11 °CWB). Pipe length: 24 ft 6 in (7.5 m), Height difference: 0 ft (0 m). (Between outdoor unit and indoor unit.) Protective function might work when using it outside the operation range. *: Sound pressure level <ul style="list-style-type: none"> Measured values in manufacturer's anechoic chamber. Because of the surrounding sound environment, the sound levels measured in actual installation conditions might be higher than the specified values here. 							

Type			Inverter heat pump		
Model name			AOU42RGLX	AOU48RGLX	
Power supply			208/230 V ~ 60 Hz		
Power supply intake			Outdoor unit		
Available voltage range			187—253 V		
Starting current			16.8		
Fan	Airflow rate	Cooling	CFM (m ³ /h)	3,973 (6,750)	
		Heating			4,061 (6,900)
	Type × Qty	Propeller × 2			
Motor output			100		
Sound pressure level *	Cooling	dB (A)	55		
	Heating		57		
Heat exchanger type	Dimensions (H × W × D)	in (mm)	49-8/5 × 35-7/16 × 1-7/16 (1,260 × 900 × 36.4)		
	Fin pitch	FPI	20		
	Rows × Stages		2 × 22 2 × 38		
	Pipe type		Copper		
	Fin	Type (Material)		Aluminum	
		Surface treatment		PC Fin	
Compressor	Type × Qty		Twin rotary × 1		
	Motor output	W	3,750		
Refrigerant	Type		R410A		
	Charge	lb oz	7 lb 10.1 oz		
		g	3,450		
Refrigerant oil	Type		POE (VG74)		
	Amount	in ³ (cm ³)	94.6 (1,550)		
Enclosure	Material		Steel		
	Color		Beige Approximate color of MUNSSELL 10YR 7.5/1.0		
Dimensions (H × W × D)	Net	in (mm)	50-13/16 × 35-7/16 × 13 (1,290 × 900 × 330)		
	Gross	in (mm)	57-1/2 × 41-5/16 × 17-1/2 (1,460 × 1,050 × 445)		
Weight	Net	lb (kg)	209 (95)		
	Gross		231 (105)		
Connection pipe	Size	Liquid	in (mm)	Ø3/8 (9.52)	
		Gas		Ø5/8 (15.88)	
	Method		Flare		
	Pre-charge length	ft (m)	98 (30)		
	Max. length		246 (75)		
	Max. height difference		98 (30)		
Operation range	Cooling	°F (°C)	-4 to 115 (-20 to 46)		
	Heating		-4 to 75 (-20 to 24)		
Drain hose	Material		LDPE		
	Size	in (mm)	Ø1/2 (13.0) [I.D.], Ø5/8 to Ø11/16 (16.0 to 16.7) [O.D.]		

NOTES:

- Specifications are based on the following conditions:
 - Cooling: Indoor temperature of 80 °FDB (26.67 °CDB) / 67 °FWB (19.44 °CWB), and outdoor temperature of 95 °FDB (35 °CDB) / 75 °FWB (23.9 °CWB).
 - Heating: Indoor temperature of 70 °FDB (21.11 °CDB) / 59 °FWB (15 °CWB), and outdoor temperature of 47 °FDB (8.33 °CDB) / 43 °FWB (6.11 °CWB).
 - Pipe length: 24 ft 6 in (7.5 m), Height difference: 0 ft (0 m). (Between outdoor unit and indoor unit.)
- Protective function might work when using it outside the operation range.
- *: Sound pressure level
 - Measured values in manufacturer's anechoic chamber.
 - Because of the surrounding sound environment, the sound levels measured in actual installation conditions might be higher than the specified values here.

2. Dimensions

2-1. Model: AOU12RLFC

Unit: in (mm)

OUTDOOR UNIT
AOU12-48R

OUTDOOR UNIT
AOU12-48R

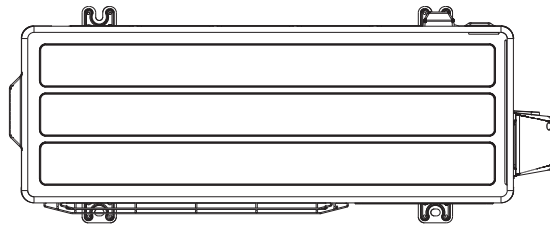

Top view

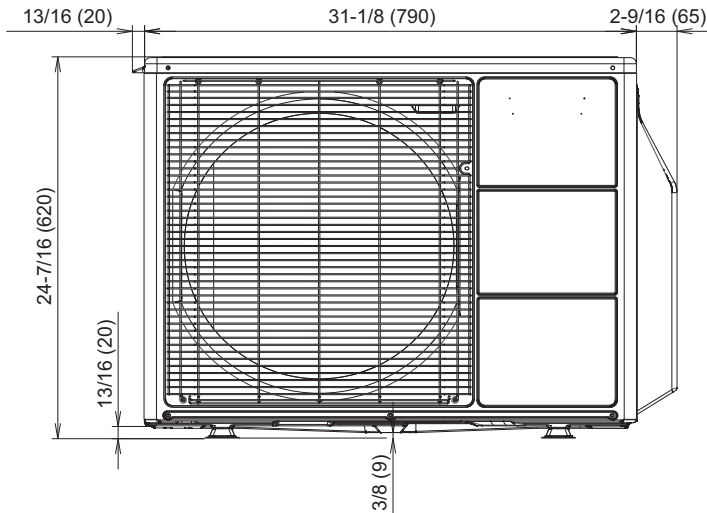

Front view

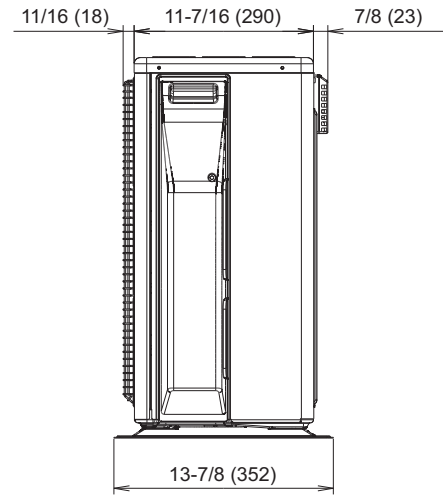

Side view

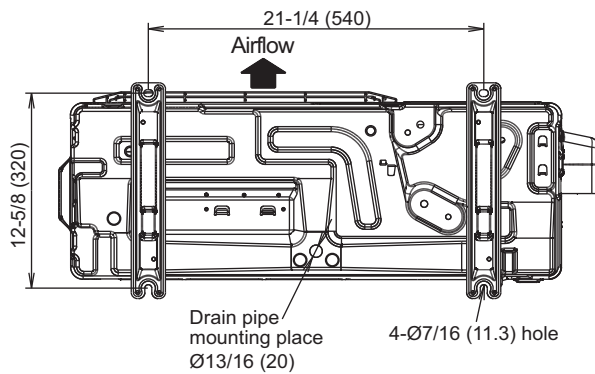

Bottom view

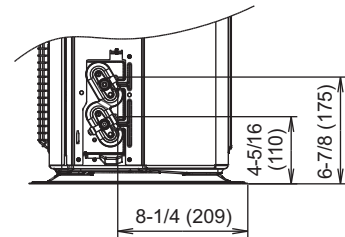

2-2. Models: AOU18RGLX, AOU24RGLX, AOU30RGLX, and AOU36RGLX

Unit: in (mm)

OUTDOOR UNIT
AOU12-48R

OUTDOOR UNIT
AOU12-48R

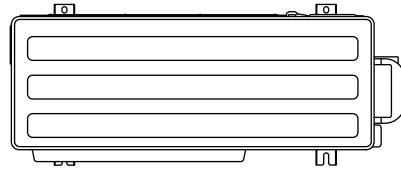

Top view

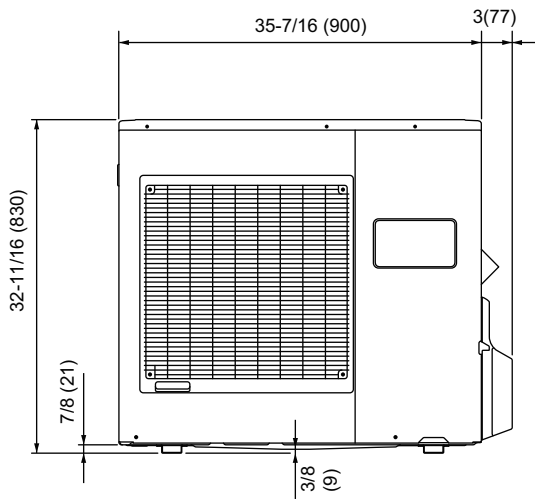

Front view

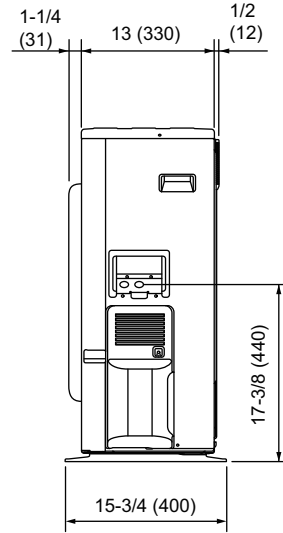

Side view

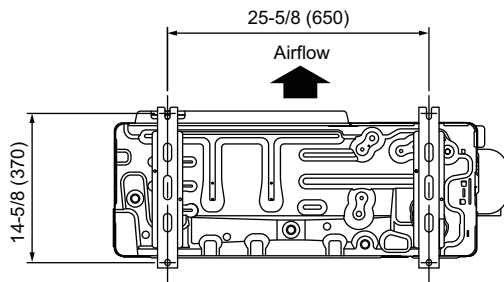

Bottom view

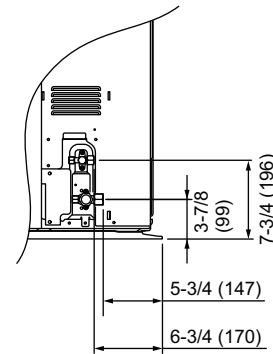

2-3. Models: AOU42RGLX and AOU48RGLX

Unit: in (mm)

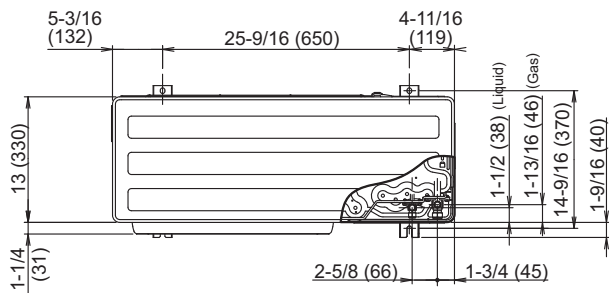

Top view

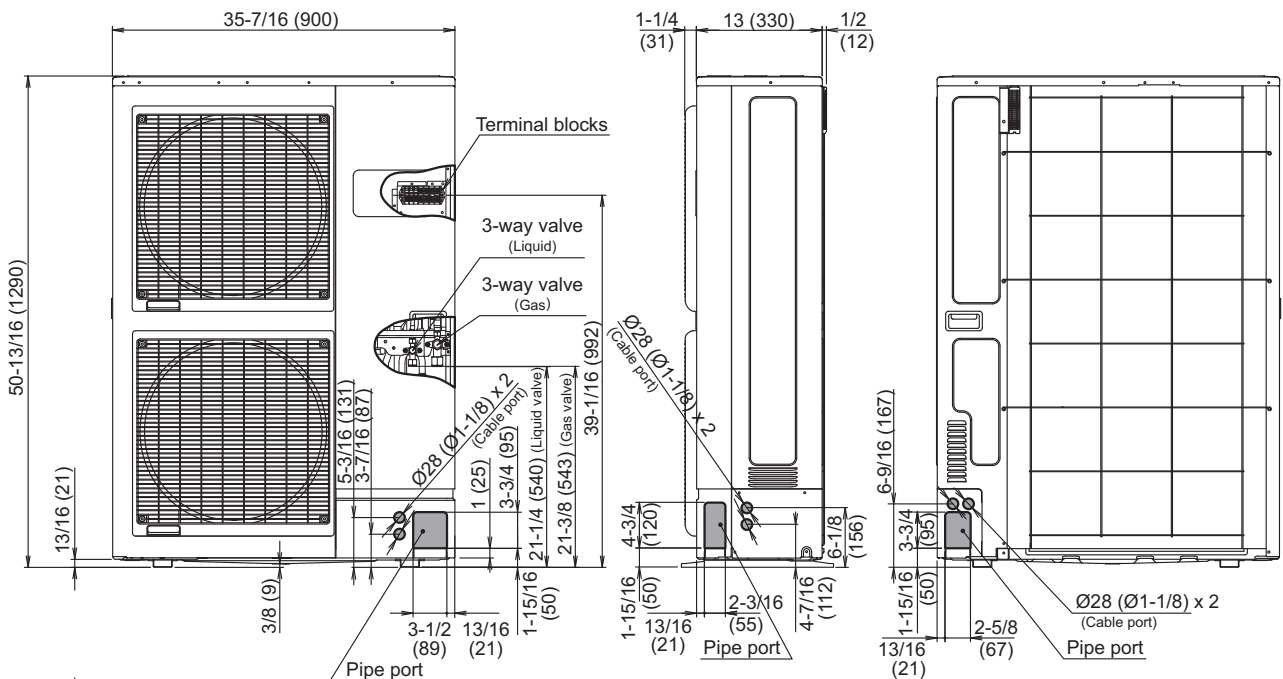

Front view

Side view

Rear view

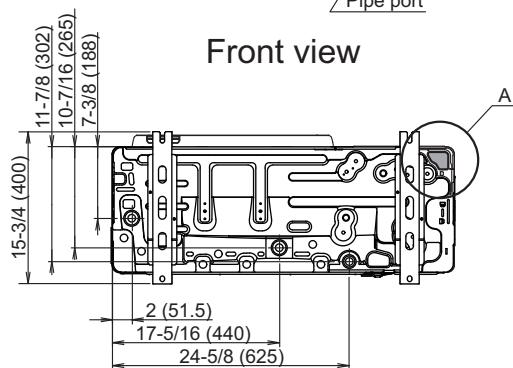

Bottom view

Detail A

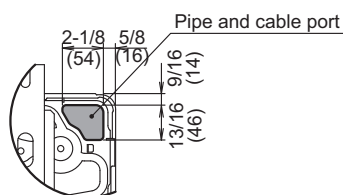

3. Installation space

3-1. Model: AOU12RLFC

■ Space requirement

Provide sufficient installation space for product safety.

● Single outdoor unit installation

- When the upper space is open:

Unit: in (mm)

When there are obstacles at the rear only.

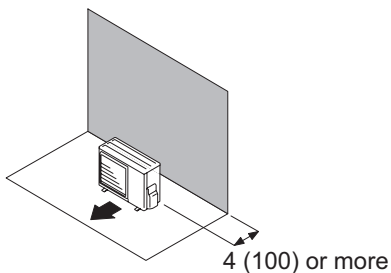

When there are obstacles at the rear and sides.

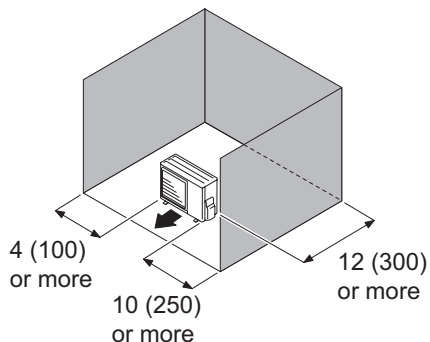

When there are obstacles at the front only.

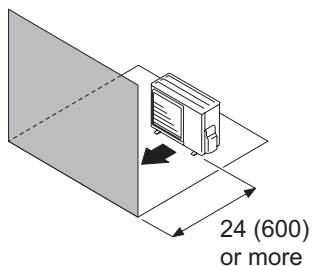

When there are obstacles at the front and rear.

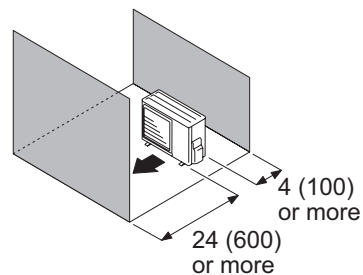

- When there is an obstruction in the upper space:

Unit: in (mm)

When there are obstacles at the rear and above.

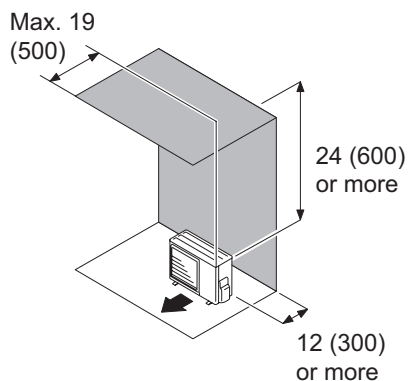

When there are obstacles at the rear, sides, and above.

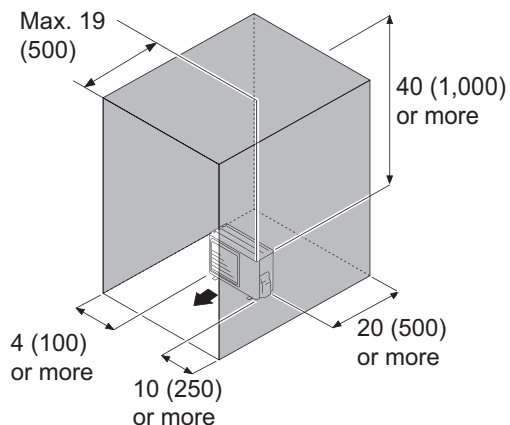

● Multiple outdoor unit installation

- When the upper space is open:

Unit: in (mm)

When there are obstacles at the rear only.

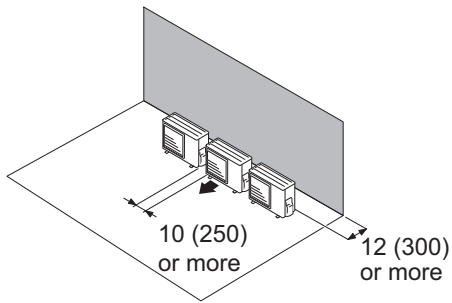

When there are obstacles at the front only.

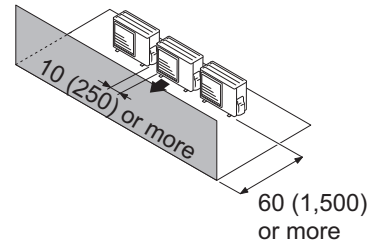

When there are obstacles at the front and rear.

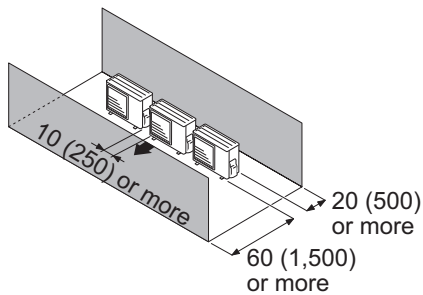

- When there is an obstruction in the upper space:

Unit: in (mm)

When there are obstacles at the rear and above.

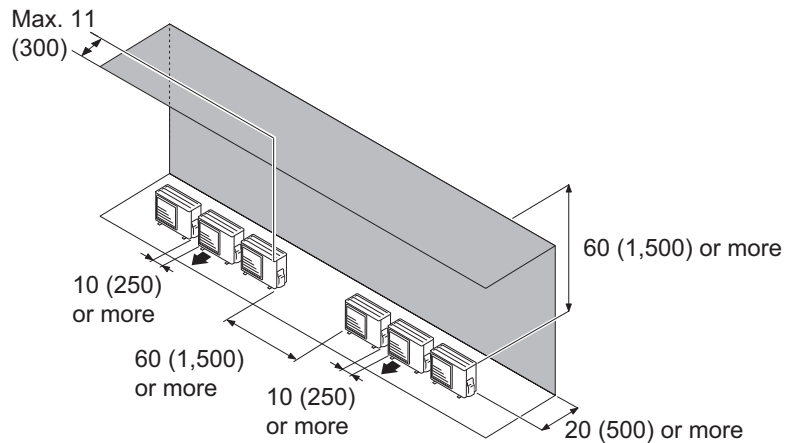

● Outdoor unit installation in multi-row

Unit: in (mm)

Single parallel unit arrangement

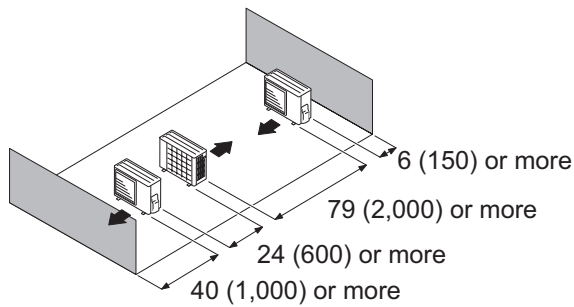

Multiple parallel unit arrangement

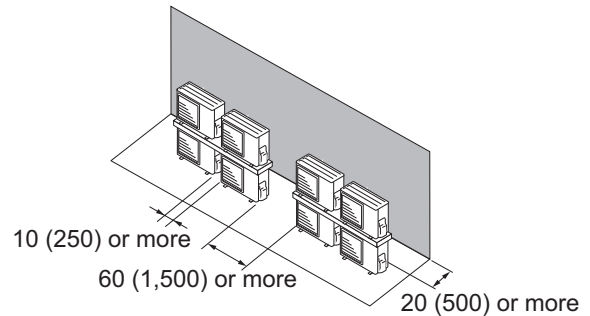
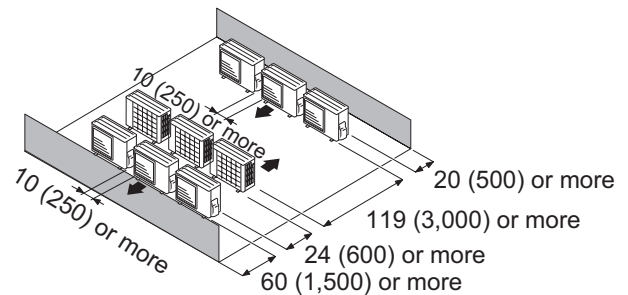

NOTES:

- If the space is larger than stated above, the condition will be the same as when there is no obstacle.
- Height above the floor level should be 2 in (50 mm) or more.
- When installing the outdoor unit, be sure to open the front and left side to obtain better operation efficiency.

⚠ CAUTION

- Do not install the outdoor unit in two-stage where the drain water could freeze. Otherwise the drainage from the upper unit may form ice and cause a malfunction of the lower unit.
- When the outdoor temperature is 32 °F (0 °C) or less, do not use the accessory drain pipe and drain cap. If the drain pipe and drain cap are used, the drain water in the pipe may freeze in extremely cold climate. (For reverse cycle model only.)
- In area with heavy snowfall, if the inlet and outlet of the outdoor unit is blocked with snow, it might become difficult to get warm, and it is likely to cause product malfunction. Construct a canopy and a pedestal, or place the unit on a high stand that is locally installed.

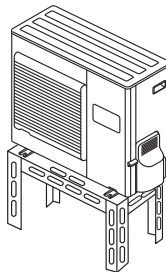

3-2. Models: AOU18RGLX, AOU24RGLX, AOU30RGLX, and AOU36RGLX

Space requirement

Provide sufficient installation space for product safety.

Single outdoor unit installation

- When the upper space is open:

Unit: in (mm)

When there are obstacles at the rear only.

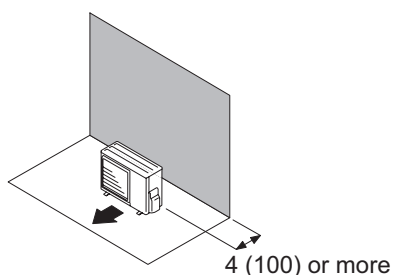

When there are obstacles at the rear and sides.

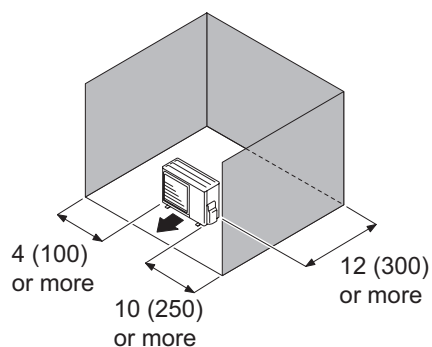

When there are obstacles at the front only.

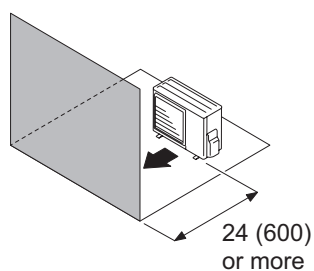

When there are obstacles at the front and rear.

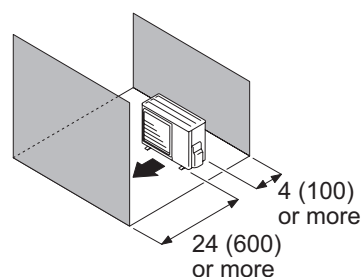

- When there is an obstruction in the upper space:

Unit: in (mm)

When there are obstacles at the rear and above.

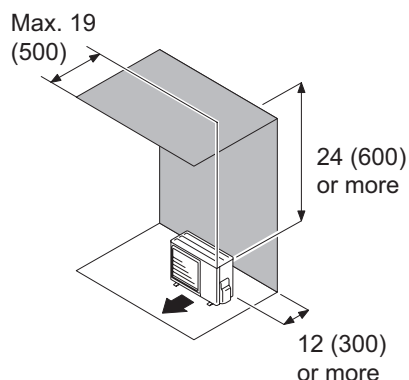

When there are obstacles at the rear, sides, and above.

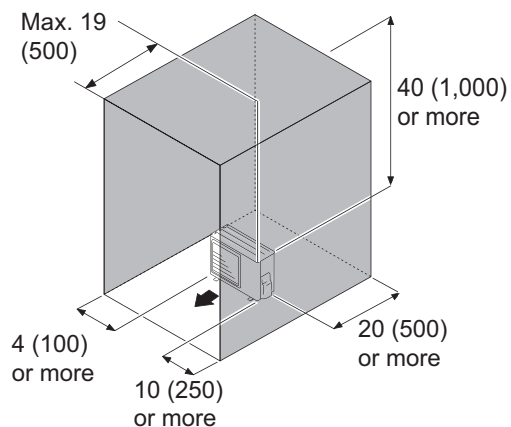

● Multiple outdoor unit installation

- When the upper space is open:

Unit: in (mm)

When there are obstacles at the rear only.

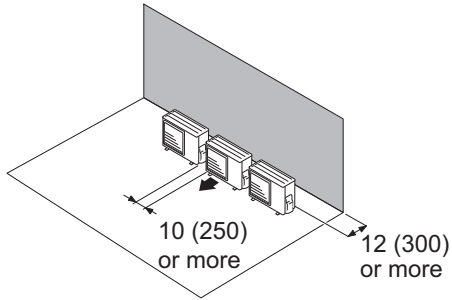

When there are obstacles at the front only.

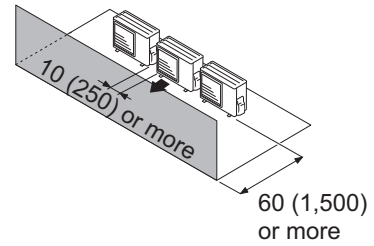

When there are obstacles at the front and rear.

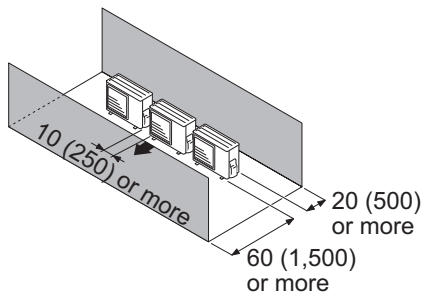

- When there is an obstruction in the upper space:

Unit: in (mm)

When there are obstacles at the rear and above.

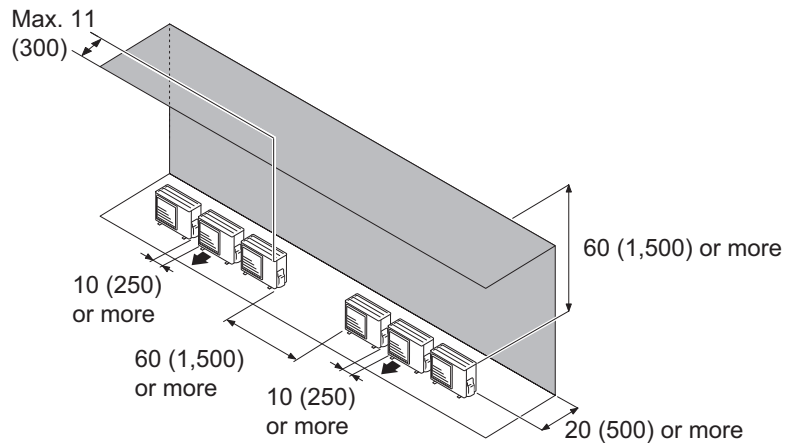

● Outdoor unit installation in multi-row

Unit: in (mm)

Single parallel unit arrangement

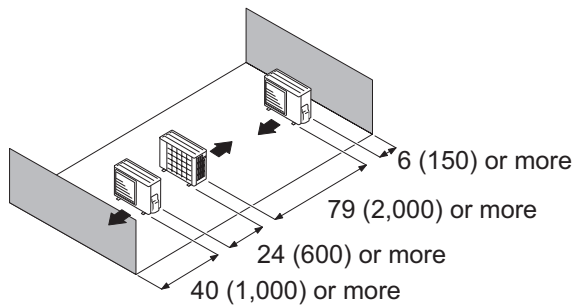

Multiple parallel unit arrangement

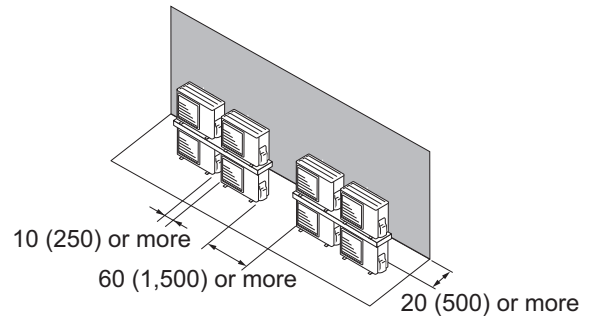
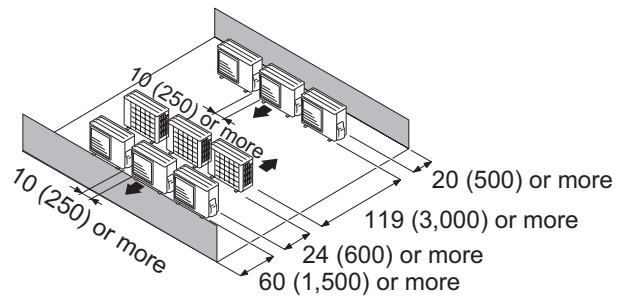

NOTES:

- If the space is larger than stated above, the condition will be the same as when there is no obstacle.
- Height above the floor level should be 2 in (50 mm) or more.
- When installing the outdoor unit, be sure to open the front and left side to obtain better operation efficiency.

⚠ CAUTION

- Do not install the outdoor unit in two-stage where the drain water could freeze. Otherwise the drainage from the upper unit may form ice and cause a malfunction of the lower unit.
- When the outdoor temperature is 32 °F (0 °C) or less, do not use the accessory drain pipe and drain cap. If the drain pipe and drain cap are used, the drain water in the pipe may freeze in extremely cold climate. (For reverse cycle model only.)
- In area with heavy snowfall, if the inlet and outlet of the outdoor unit is blocked with snow, it might become difficult to get warm, and it is likely to cause product malfunction. Construct a canopy and a pedestal, or place the unit on a high stand that is locally installed.

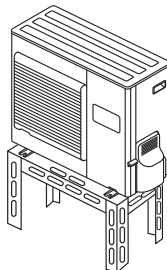

3-3. Models: AOU42RGLX and AOU48RGLX

■ Space requirement

Provide sufficient installation space for product safety.

● Single outdoor unit installation

- When the upper space is open:

Unit: in (mm)

When there are obstacles at the rear only.

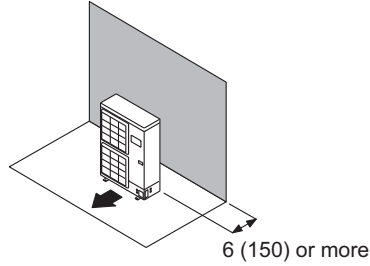

When there are obstacles at the rear and sides.

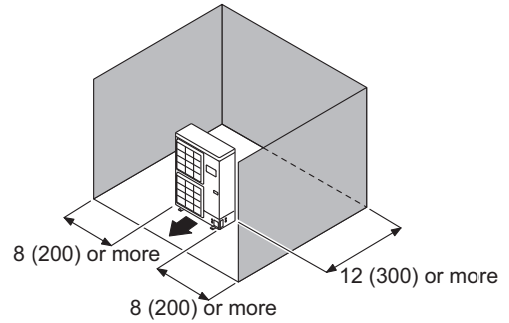

When there are obstacles at the front only.

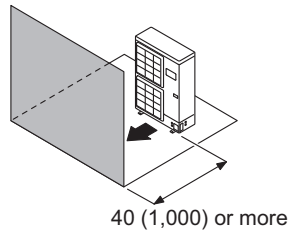

When there are obstacles at the front and rear.

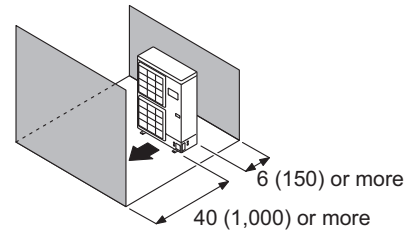

- When there is an obstruction in the upper space:

Unit: in (mm)

When there are obstacles at the rear and above.

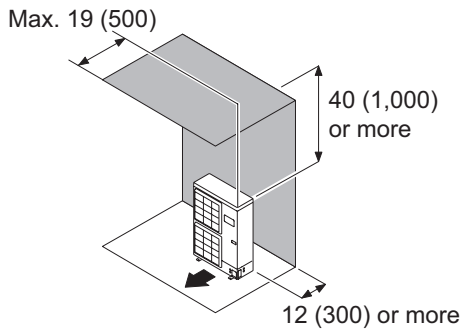

When there are obstacles at the rear, sides, and above.

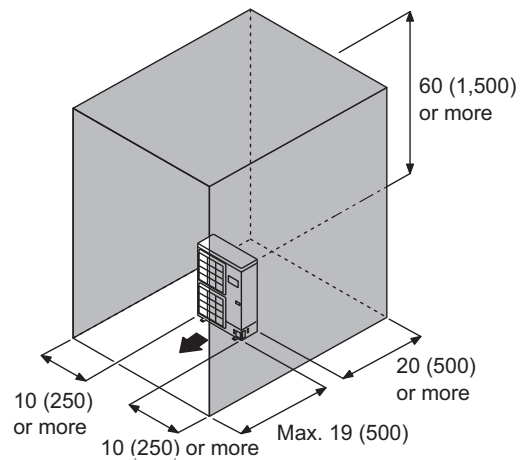

● Multiple outdoor unit installation

- When the upper space is open:

Unit: in (mm)

When there are obstacles at the rear only.

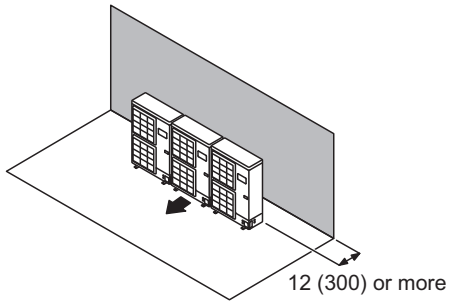

When there are obstacles at the front only.

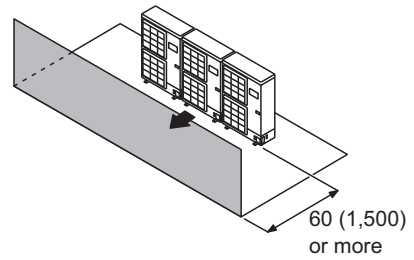

When there are obstacles at the front and rear.

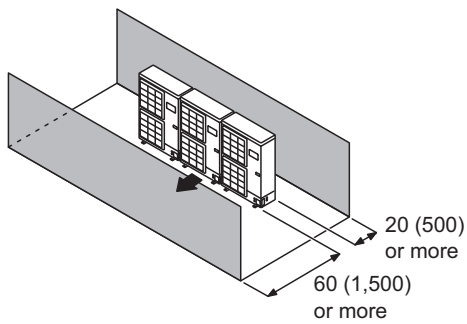

- When there is an obstruction in the upper space:

Unit: in (mm)

When there are obstacles at the rear and above.

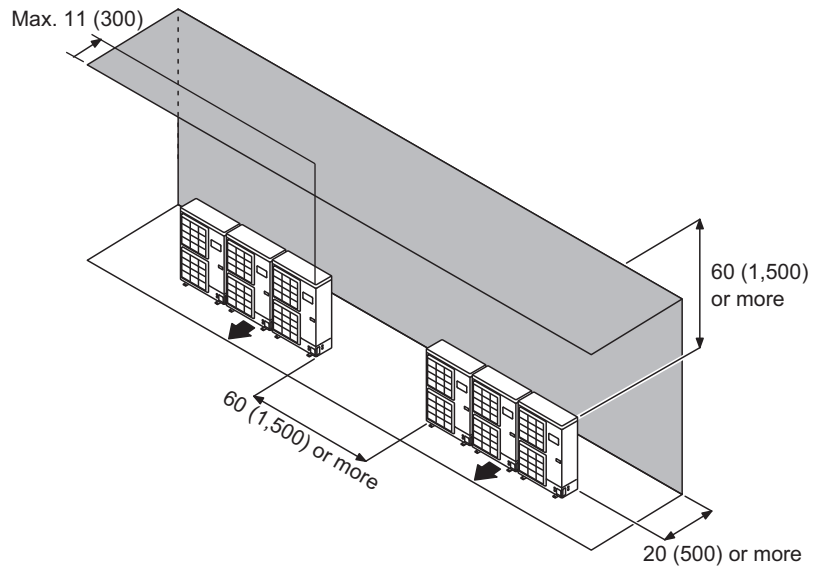

● Outdoor unit installation in multi-row

Unit: in (mm)

Single parallel unit arrangement

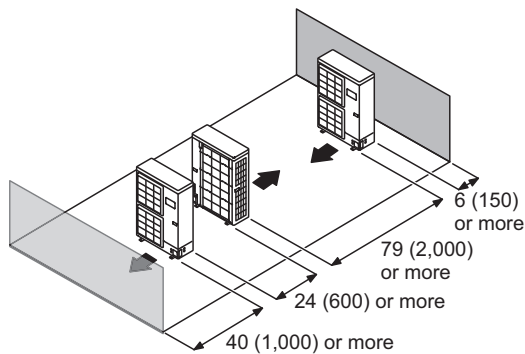

Multiple parallel unit arrangement

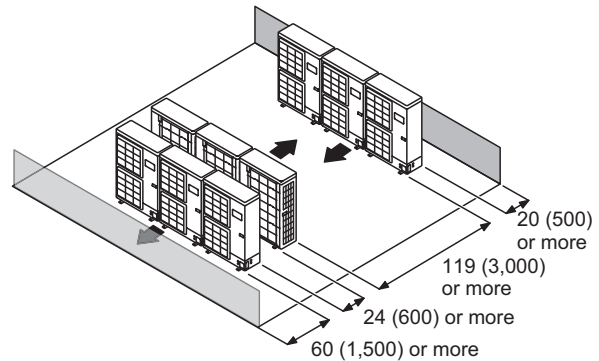

NOTES:

- If the space is larger than stated above, the condition will be the same as when there is no obstacle.
- Height above the floor level should be 2 in (50 mm) or more.
- When installing the outdoor unit, be sure to open the front and left side to obtain better operation efficiency.

⚠ CAUTION

- When the outdoor temperature is 32 °F (0 °C) or less, do not use the accessory drain pipe and drain cap. If the drain pipe and drain cap are used, the drain water in the pipe may freeze in extremely cold climate. (For reverse cycle model only.)
- In area with heavy snowfall, if the inlet and outlet of the outdoor unit is blocked with snow, it might become difficult to get warm, and it is likely to cause product malfunction. Construct a canopy and a pedestal, or place the unit on a high stand that is locally installed.

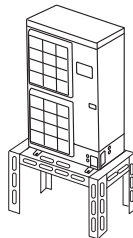

4. Refrigerant circuit

4-1. Model: AOU12RLFC

OUTDOOR UNIT
AOU12-48R

OUTDOOR UNIT
AOU12-48R

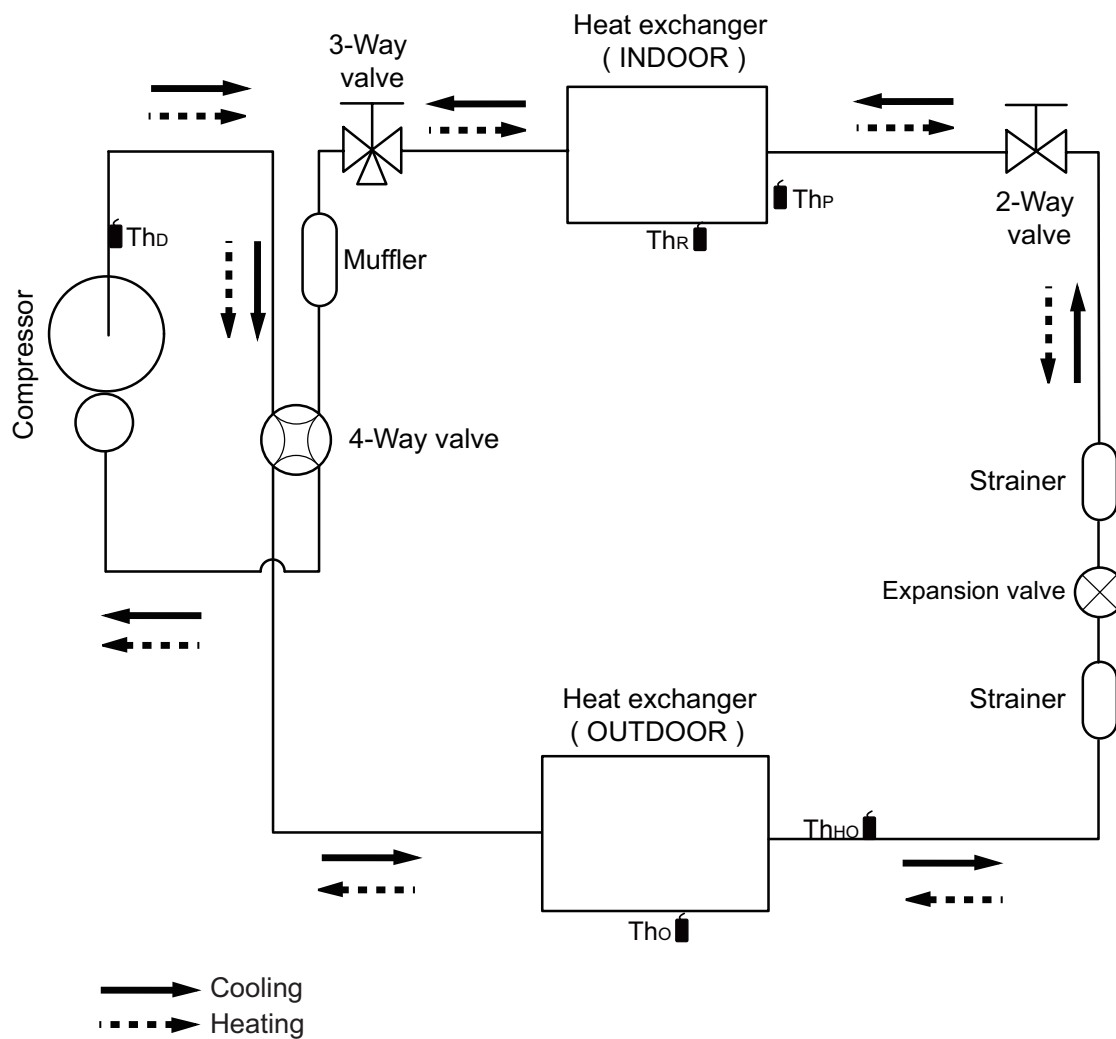

- Th_D : Thermistor (Discharge temperature)
- Th_O : Thermistor (Outdoor temperature)
- Th_{HO} : Thermistor (Heat exchanger Out temperature)
- Th_R : Thermistor (Room temperature)
- Th_P : Thermistor (Pipe temperature)

4-2. Models: AOU18RGLX, AOU24RGLX, AOU30RGLX, and AOU36RGLX

OUTDOOR UNIT
AOU12-48R

OUTDOOR UNIT
AOU12-48R

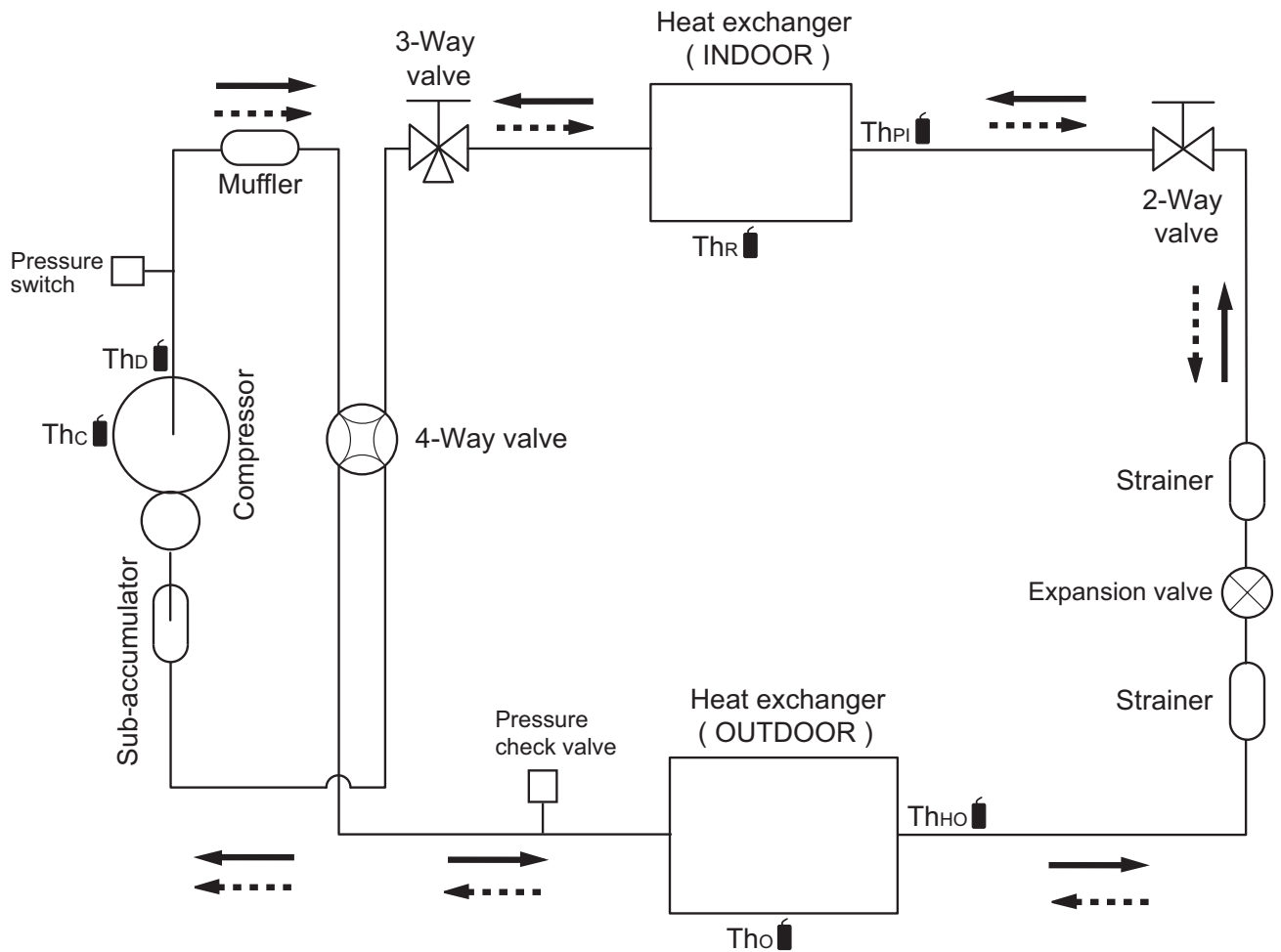

—————> : Cooling
> : Heating

- Th_c : Thermistor (Compressor temperature)
- Th_d : Thermistor (Discharge temperature)
- Th_o : Thermistor (Outdoor temperature)
- Th_{Ho} : Thermistor (Heat exchanger Out temperature)
- Th_R : Thermistor (Room temperature)
- Th_{PI} : Thermistor (Pipe temperature)

4-3. Models: AOU42RGLX and AOU48RGLX

OUTDOOR UNIT
AOU12-48R

OUTDOOR UNIT
AOU12-48R

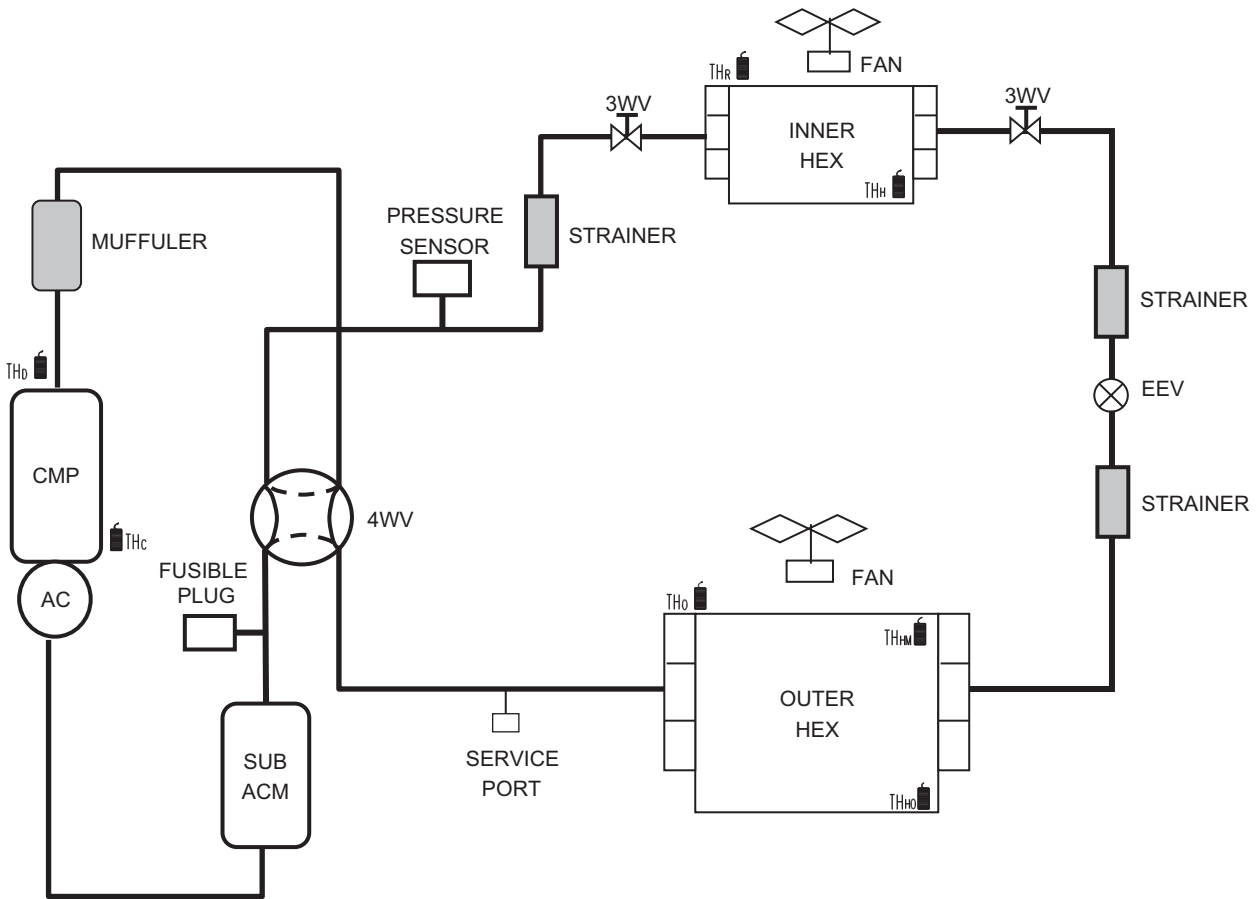

THc: Thermistor (Compressor temperature)

THo: Thermistor (Discharge temperature)

THm: Thermistor (Heat exchanger Med temperature)

THo: Thermistor (Heat exchanger Out temperature)

THo: Thermistor (Outdoor temperature)

THr: Thermistor (Room temperature)

THh: Thermistor (Heat exchanger temperature)

5. Wiring diagrams

5-1. Model: AOU12RLFC

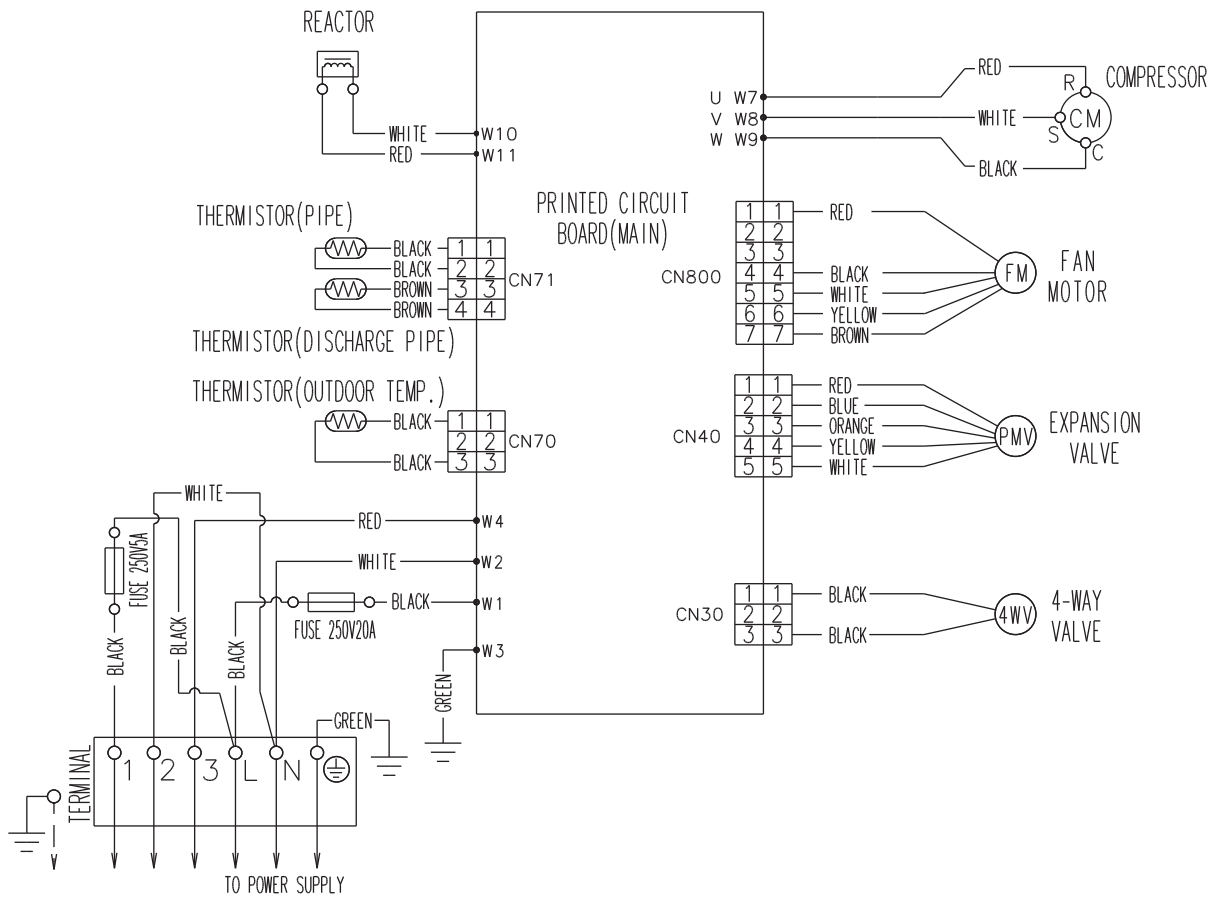

OUTDOOR UNIT
AOU12-48R

OUTDOOR UNIT
AOU12-48R

5-2. Model: AOU18RGLX

OUTDOOR UNIT
AOU12-48R

OUTDOOR UNIT
AOU12-48R

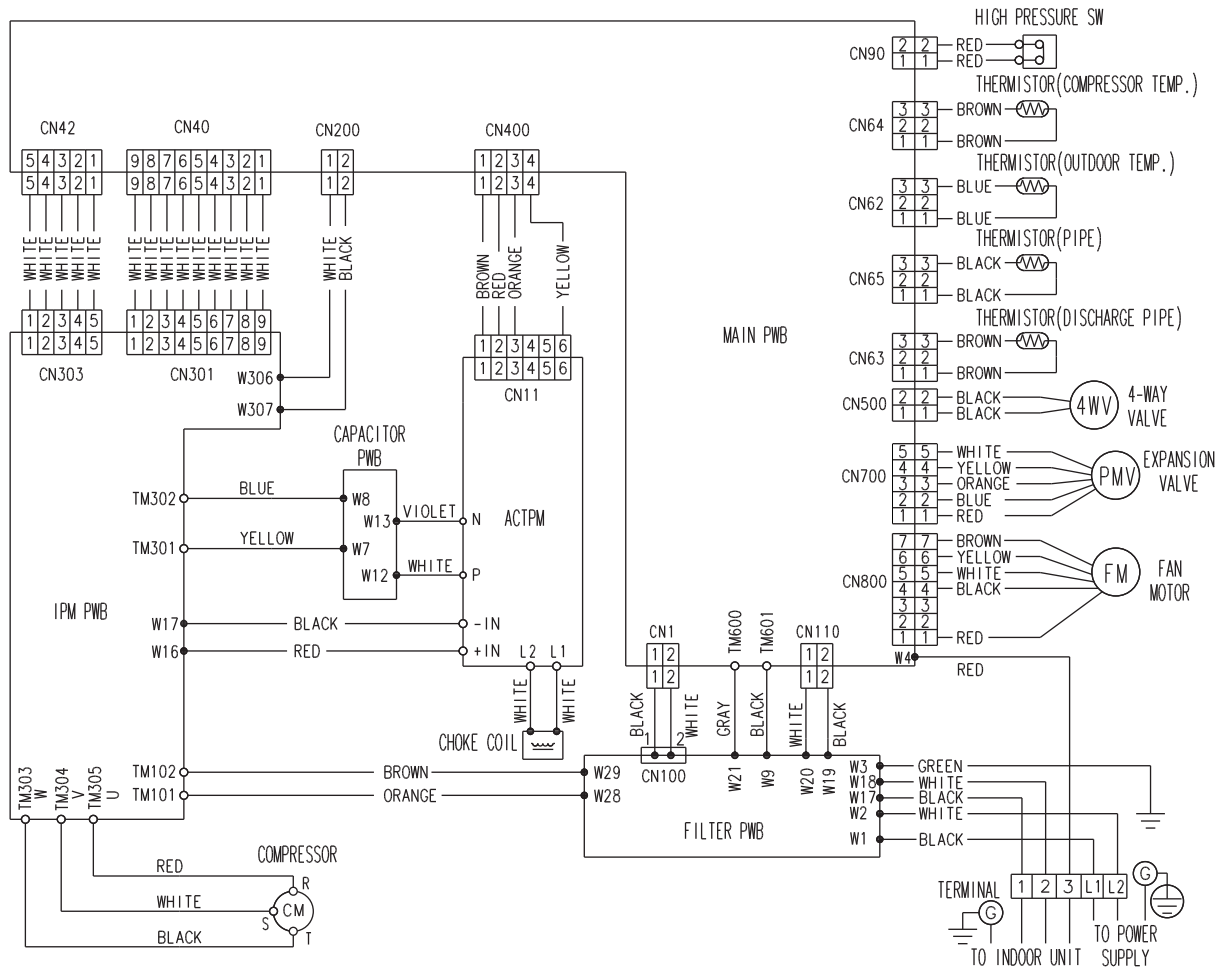

5-3. Models: AOU24RGLX, AOU30RGLX, and AOU36RGLX

OUTDOOR UNIT
AOU12-48R

OUTDOOR UNIT
AOU12-48R

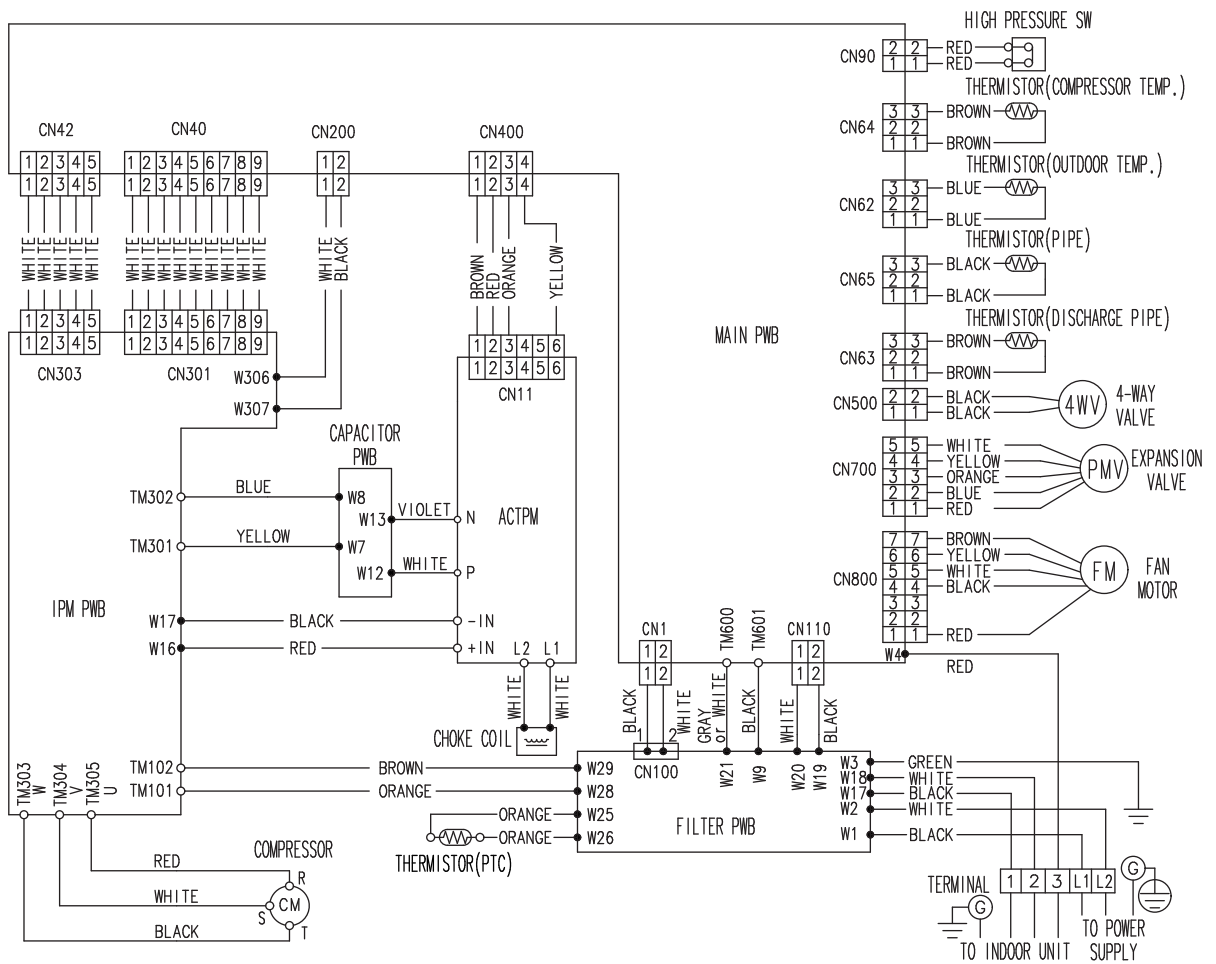

5-4. Models: AOU42RGLX and AOU48RGLX

OUTDOOR UNIT
AOU12-48R

OUTDOOR UNIT
AOU12-48R

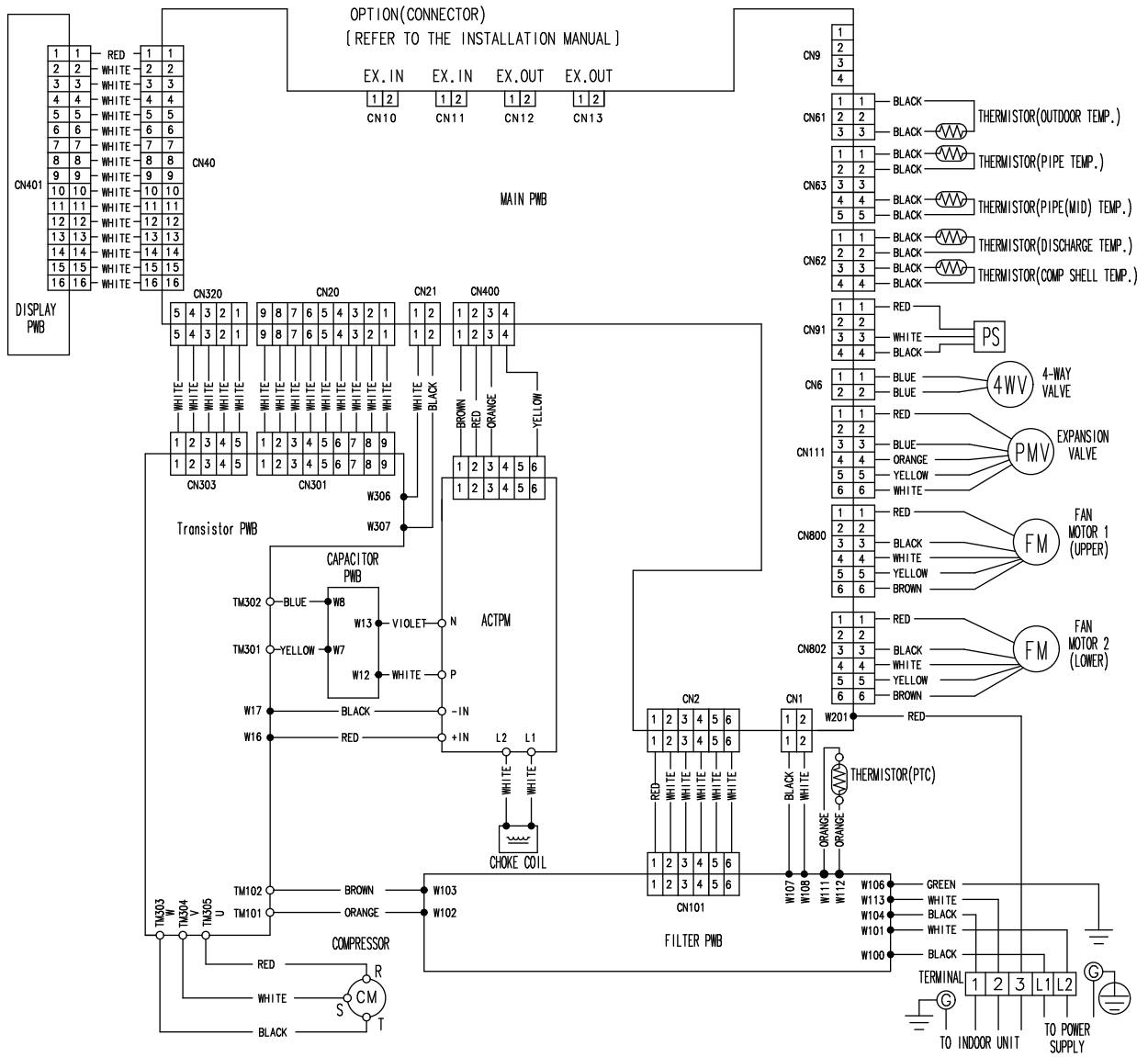

6. Capacity compensation rate for pipe length and height difference

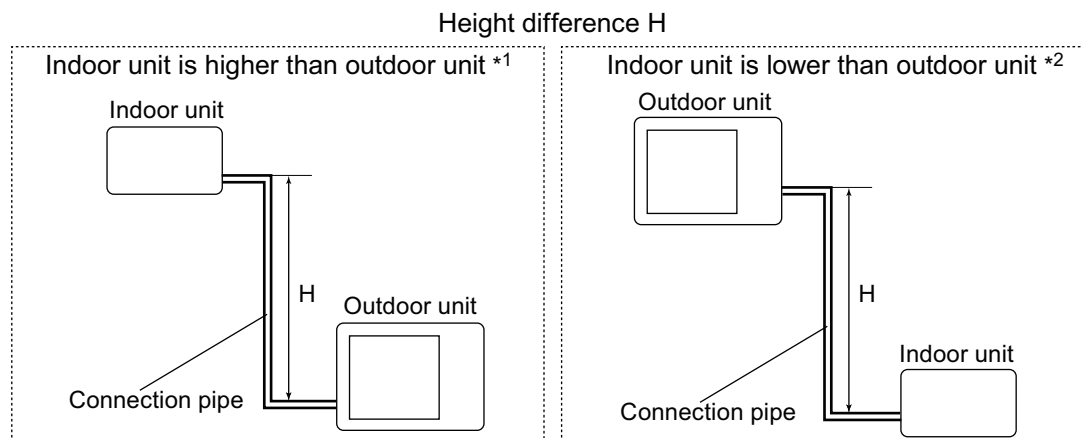

6-1. Model: AOU12RLFC

NOTE: Values mentioned in the table are calculated based on the maximum capacity.

COOLING		Pipe length						
		m						
			ft	5	7.5	10	15	20
Height difference H	Indoor unit is higher than outdoor unit *1	15	49	—	—	—	0.877	0.874
		10	32	—	—	0.956	0.891	0.888
		7.5	24	—	0.988	0.960	0.895	0.892
		5	16	1.017	0.992	0.964	0.899	0.895
	0	0	1.025	1.000	0.971	0.906	0.902	
Indoor unit is lower than outdoor unit *2	-5	-16	1.025	1.000	0.971	0.906	0.902	
	-7.5	-24	—	1.000	0.971	0.906	0.902	
	-10	-32	—	—	0.971	0.906	0.902	
	-15	-49	—	—	—	0.906	0.902	

HEATING		Pipe length						
		m						
			ft	5	7.5	10	15	20
Height difference H	Indoor unit is higher than outdoor unit *1	15	49	—	—	—	0.933	0.925
		10	32	—	—	0.981	0.933	0.925
		7.5	24	—	1.000	0.981	0.933	0.925
		5	16	1.017	1.000	0.981	0.933	0.925
	0	0	1.017	1.000	0.981	0.933	0.925	
Indoor unit is lower than outdoor unit *2	-5	-16	1.012	0.995	0.976	0.928	0.920	
	-7.5	-24	—	0.993	0.974	0.926	0.918	
	-10	-32	—	—	0.971	0.923	0.916	
	-15	-49	—	—	—	0.914	0.906	

6-2. Models: AOU18RGLX, AOU24RGLX, AOU30RGLX, and AOU36RGLX

NOTE: Values mentioned in the table are calculated based on the maximum capacity.

COOLING		Pipe length								
		m	ft	5	7.5	10	20	30	40	50
				16	24	32	65	98	131	164
Height difference H	Indoor unit is higher than outdoor unit *1	30	98	—	—	—	—	0.913	0.899	0.881
		20	65	—	—	—	0.941	0.929	0.914	0.896
		10	32	—	—	0.974	0.957	0.944	0.930	0.911
		7.5	24	—	0.988	0.978	0.960	0.948	0.934	0.914
		5	16	0.998	0.992	0.982	0.964	0.952	0.938	0.919
	Indoor unit is lower than outdoor unit *2	0	0	1.000	1.000	0.989	0.972	0.960	0.945	0.926
		-5	-16	1.000	1.000	0.989	0.972	0.960	0.945	0.926
		-7.5	-24	—	1.000	0.989	0.972	0.960	0.945	0.926
		-10	-32	—	—	0.989	0.972	0.960	0.945	0.926
		-20	-65	—	—	—	0.972	0.960	0.945	0.926
	-30	-98	—	—	—	—	0.960	0.945	0.926	

HEATING		Pipe length								
		m	ft	5	7.5	10	20	30	40	50
				16	24	32	65	98	131	164
Height difference H	Indoor unit is higher than outdoor unit *1	30	98	—	—	—	—	0.939	0.922	0.907
		20	65	—	—	—	0.963	0.939	0.922	0.907
		10	32	—	—	0.999	0.963	0.939	0.922	0.907
		7.5	24	—	1.000	0.999	0.963	0.939	0.922	0.907
		5	16	1.000	1.000	0.999	0.963	0.939	0.922	0.907
	Indoor unit is lower than outdoor unit *2	0	0	1.000	1.000	0.999	0.963	0.939	0.922	0.907
		-5	-16	1.000	0.995	0.995	0.958	0.934	0.917	0.903
		-7.5	-24	—	0.983	0.992	0.955	0.932	0.915	0.900
		-10	-32	—	—	0.990	0.953	0.929	0.912	0.898
		-20	-65	—	—	—	0.943	0.920	0.903	0.889
	-30	-98	—	—	—	—	0.911	0.894	0.880	

6-3. Models: AOU42RGLX and AOU48RGLX

NOTE: Values mentioned in the table are calculated based on the maximum capacity.

COOLING		Pipe length										
		m	5	7.5	10	20	30	40	50	60	75	
		ft	16	24	32	65	98	131	164	196	246	
Height difference H	Indoor unit is higher than outdoor unit *1	30	98	—	—	—	—	0.879	0.847	0.814	0.782	0.743
		20	65	—	—	—	0.927	0.894	0.861	0.828	0.795	0.755
		10	32	—	—	0.975	0.942	0.909	0.875	0.842	0.808	0.768
		7.5	24	—	0.988	0.979	0.946	0.912	0.879	0.845	0.811	0.771
		5	16	0.992	0.992	0.983	0.950	0.916	0.882	0.848	0.815	0.774
		0	0	1.000	1.000	0.991	0.957	0.923	0.889	0.855	0.821	0.780
	Indoor unit is lower than outdoor unit *2	-5	-16	1.000	1.000	0.991	0.957	0.923	0.889	0.855	0.821	0.780
		-7.5	-24	—	1.000	0.991	0.957	0.923	0.889	0.855	0.821	0.780
		-10	-32	—	—	0.991	0.957	0.923	0.889	0.855	0.821	0.780
		-20	-65	—	—	—	0.957	0.923	0.889	0.855	0.821	0.780
-30		-98	—	—	—	—	0.923	0.889	0.855	0.821	0.780	

HEATING		Pipe length										
		m	5	7.5	10	20	30	40	50	60	75	
		ft	16	24	32	65	98	131	164	196	246	
Height difference H	Indoor unit is higher than outdoor unit *1	30	98	—	—	—	—	0.978	0.968	0.958	0.948	0.935
		20	65	—	—	—	0.988	0.978	0.968	0.958	0.948	0.935
		10	32	—	—	0.998	0.988	0.978	0.968	0.958	0.948	0.935
		7.5	24	—	1.000	0.998	0.988	0.978	0.968	0.958	0.948	0.935
		5	16	1.000	1.000	0.998	0.988	0.978	0.968	0.958	0.948	0.935
		0	0	1.000	1.000	0.998	0.988	0.978	0.968	0.958	0.948	0.935
	Indoor unit is lower than outdoor unit *2	-5	-16	0.995	0.995	0.993	0.983	0.973	0.963	0.953	0.943	0.930
		-7.5	-24	—	0.993	0.990	0.980	0.970	0.960	0.950	0.940	0.928
		-10	-32	—	—	0.988	0.978	0.968	0.958	0.948	0.938	0.926
		-20	-65	—	—	—	0.968	0.958	0.948	0.938	0.929	0.916
-30		-98	—	—	—	—	0.948	0.939	0.929	0.919	0.907	

7. Additional charge calculation

7-1. Model: AOU12RLFC

Refrigerant type	R410A	
Refrigerant amount	lb oz	2 lb 10 oz
	g	1,200

■ Refrigerant charge

Total pipe length	ft	49 or less	66 (Max.)	0.22 oz/ft (20 g/m)
	m	15 or less	20 (Max.)	
Additional charge	oz	0	3.5	
	g	0	100	

7-2. Model: AOU18RGLX

Refrigerant type	R410A	
Refrigerant amount	lb oz	4 lb 10.1 oz
	g	2,100

■ Refrigerant charge

Total pipe length	ft	66 or less	98	131	164 (Max.)	0.22 oz/ft (20 g/m)
	m	20 or less	30	40	50 (Max.)	
Additional charge	oz	0	7.1	14.1	21.2	
	g	0	200	400	600	

7-3. Models: AOU24RGLX, AOU30RGLX, and AOU36RGLX

Refrigerant type	R410A	
Refrigerant amount	lb oz	4 lb 10.1 oz
	g	2,100

■ Refrigerant charge

Total pipe length	ft	66 or less	98	131	164 (Max.)	0.43 oz/ft (40 g/m)
	m	20 or less	30	40	50 (Max.)	
Additional charge	oz	0	14.1	28.2	42.3	
	g	0	400	800	1,200	

7-4. Models: AOU42RGLX and AOU48RGLX

Refrigerant type		R410A
Refrigerant amount	lb oz	7 lb 10.1 oz
	g	3,450

■ Refrigerant charge

Total pipe length	ft	98 or less	131	164	196	246 (Max.)	0.43 oz/ft (40 g/m)
	m	30 or less	40	50	60	75 (Max.)	
Additional charge	oz	0	14.1	28.2	42.3	63.5	
	g	0	400	800	1,200	1,800	

8. Airflow

8-1. Model: AOU12RLFC

● Cooling

m ³ /h	2,050
l/s	569
CFM	1,207

● Heating

m ³ /h	1,840
l/s	511
CFM	1,083

8-2. Model: AOU18RGLX

● Cooling

m ³ /h	2,000
l/s	556
CFM	1,177

● Heating

m ³ /h	2,530
l/s	703
CFM	1,489

8-3. Model: AOU24RGLX

● Cooling

m ³ /h	3,600
l/s	1,000
CFM	2,119

● Heating

m ³ /h	3,600
l/s	1,000
CFM	2,119

8-4. Model: AOU30RGLX**● Cooling**

m ³ /h	3,600
l/s	1,000
CFM	2,119

● Heating

m ³ /h	3,600
l/s	1,000
CFM	2,119

8-5. Model: AOU36RGLX**● Cooling**

m ³ /h	3,800
l/s	1,056
CFM	2,237

● Heating

m ³ /h	3,800
l/s	1,056
CFM	2,237

8-6. Model: AOU42RGLX**● Cooling**

m ³ /h	6,750
l/s	1,875
CFM	3,973

● Heating

m ³ /h	6,200
l/s	1,722
CFM	3,649

8-7. Model: AOU48RGLX

● Cooling

m ³ /h	6,900
l/s	1,917
CFM	4,061

● Heating

m ³ /h	6,950
l/s	1,931
CFM	4,091

9. Operation noise (sound pressure)

9-1. Noise level curve

Model: AOU12RLFC

Cooling

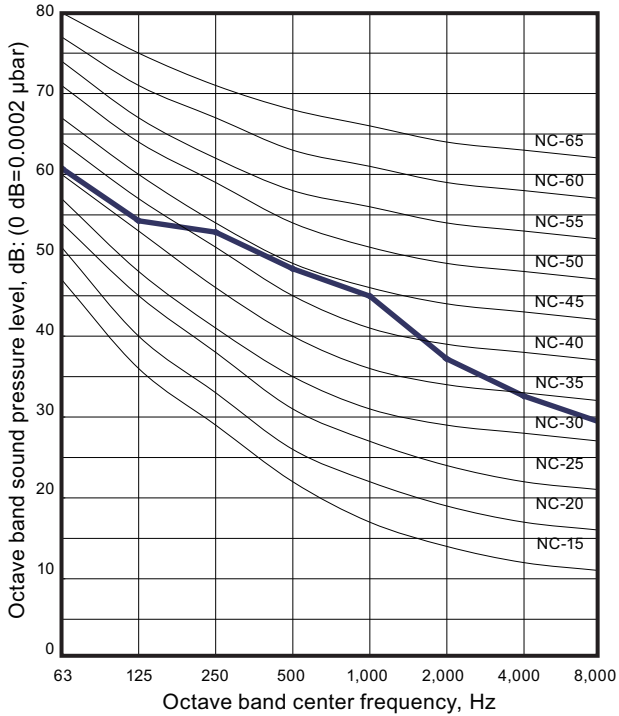

Heating

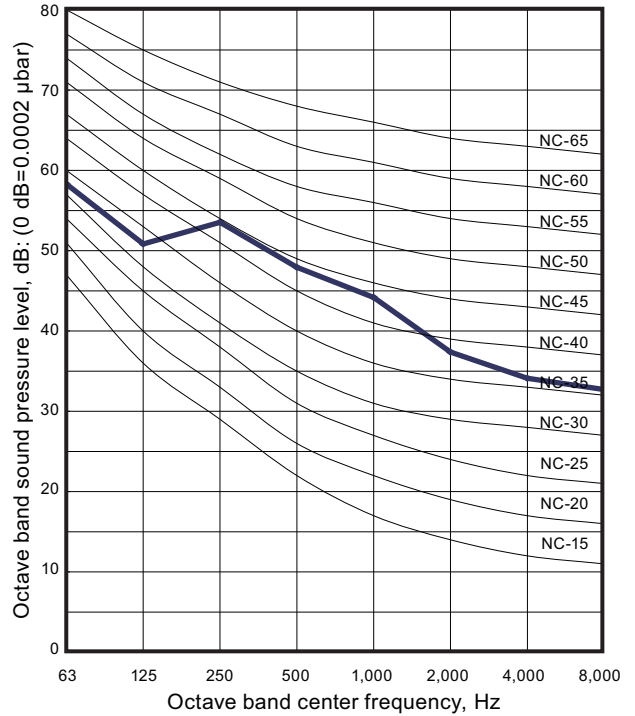

Model: AOU18RGLX

Cooling

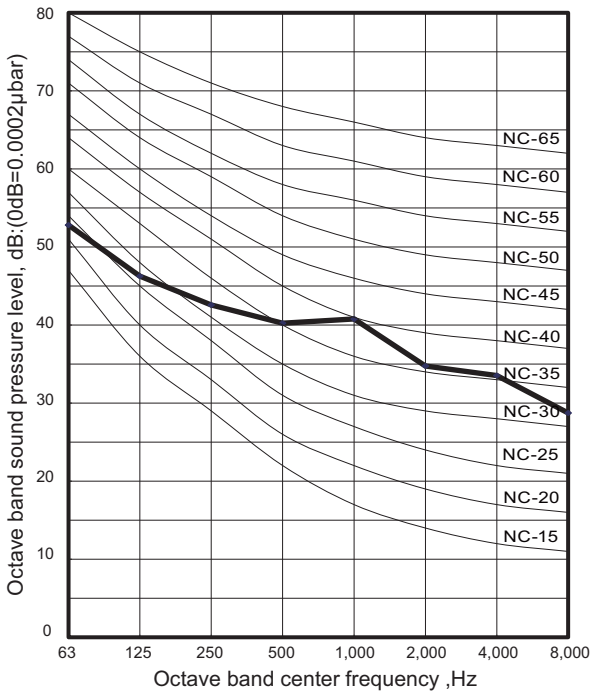

Heating

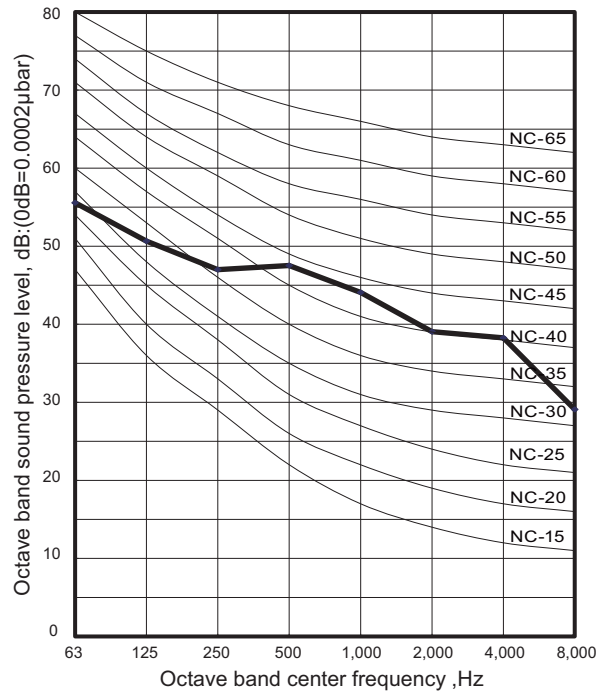

OUTDOOR UNIT
AOU12-48R

OUTDOOR UNIT
AOU12-48R

Model: AOU24RGLX

Cooling

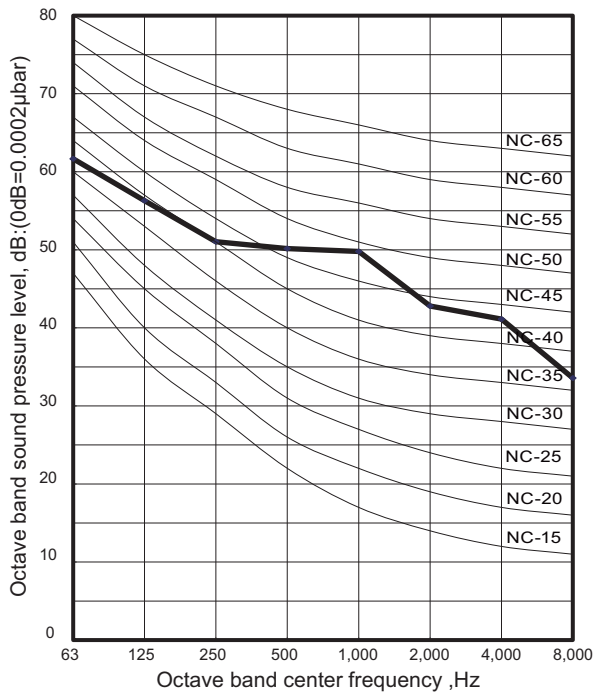

Heating

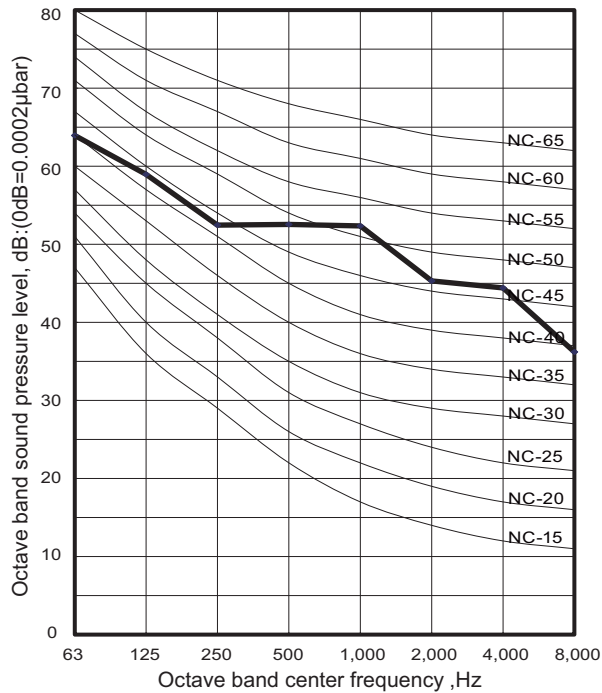

OUTDOOR UNIT
AOU12-48R

OUTDOOR UNIT
AOU12-48R

Model: AOU30RGLX

Cooling

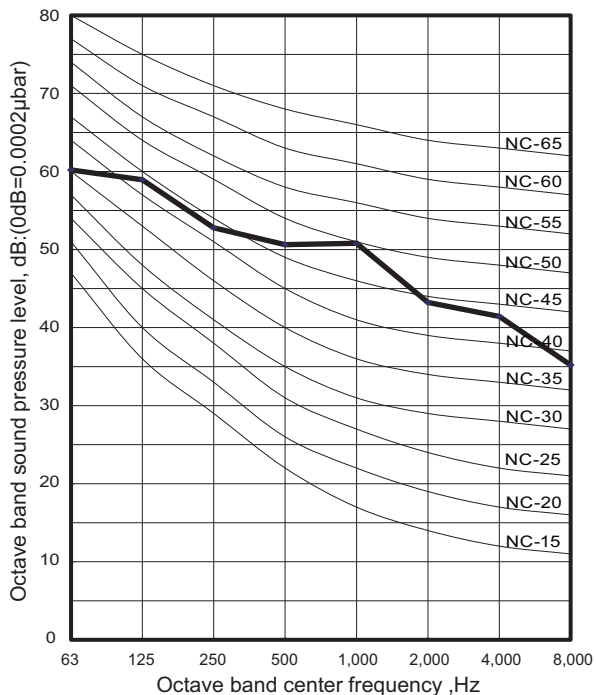

Heating

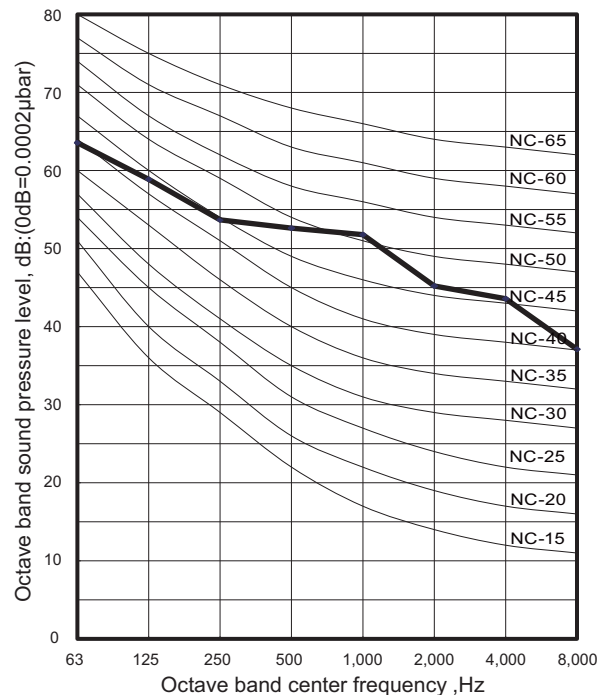

Model: AOU36RGLX

Cooling

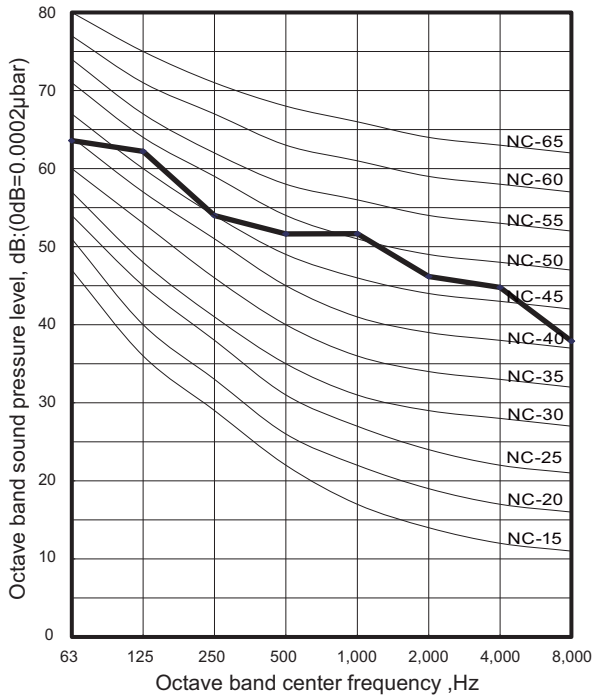

Heating

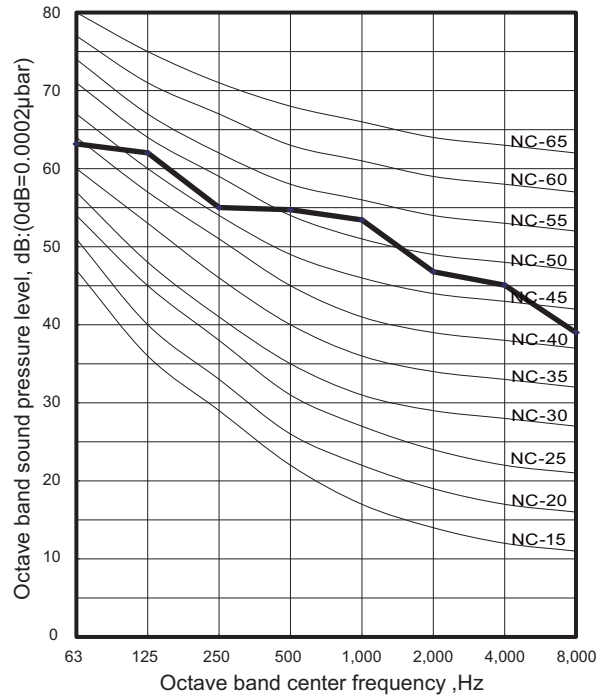

OUTDOOR UNIT
AOU12-48R

OUTDOOR UNIT
AOU12-48R

Model: AOU42RGLX

Cooling

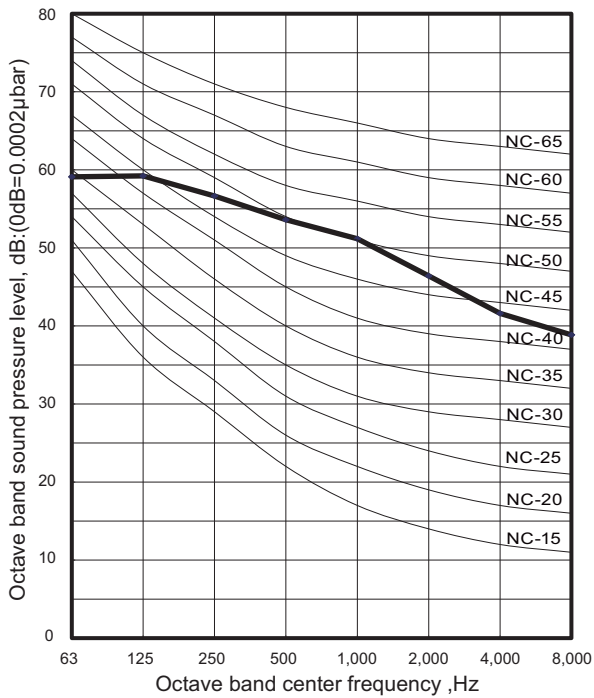

Heating

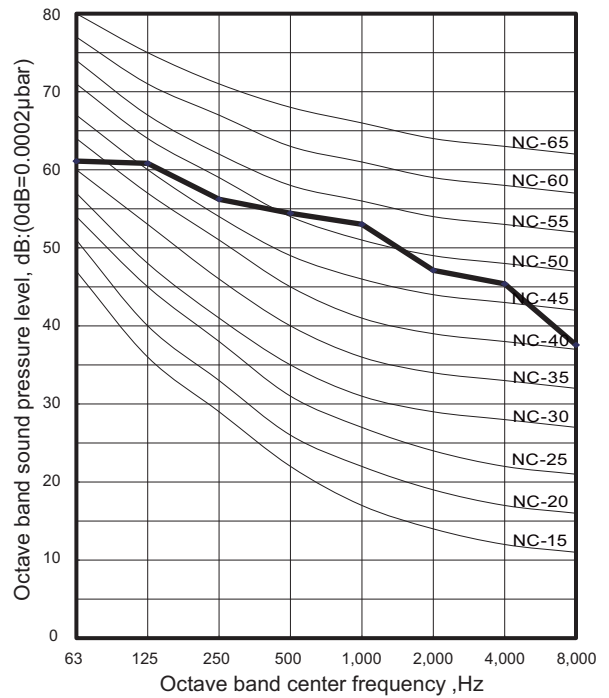

Model: AOU48RGLX

● Cooling

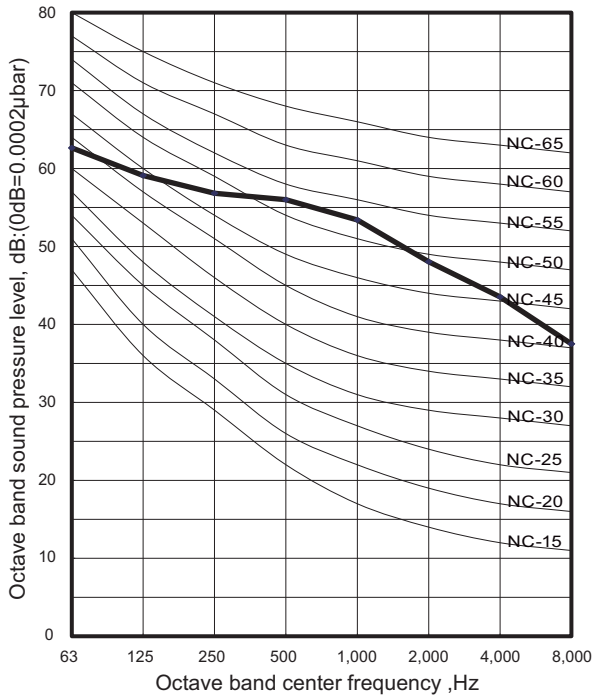

● Heating

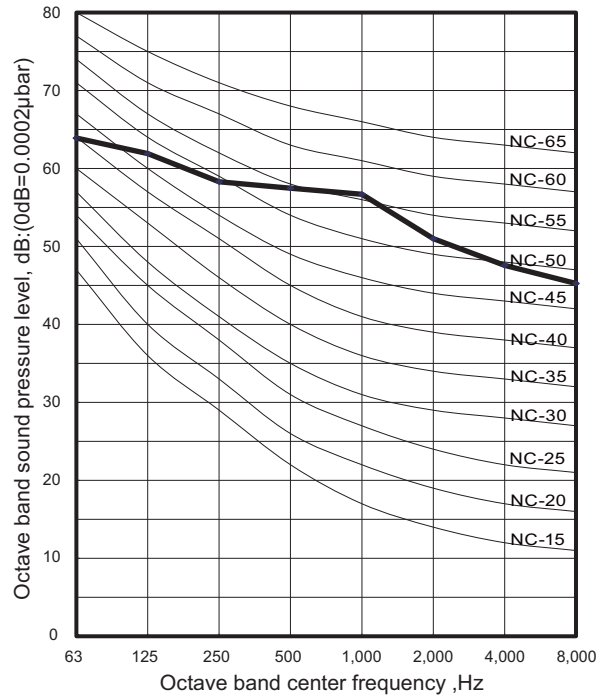

OUTDOOR UNIT
AOU12-48R

OUTDOOR UNIT
AOU12-48R

9-2. Sound level check point

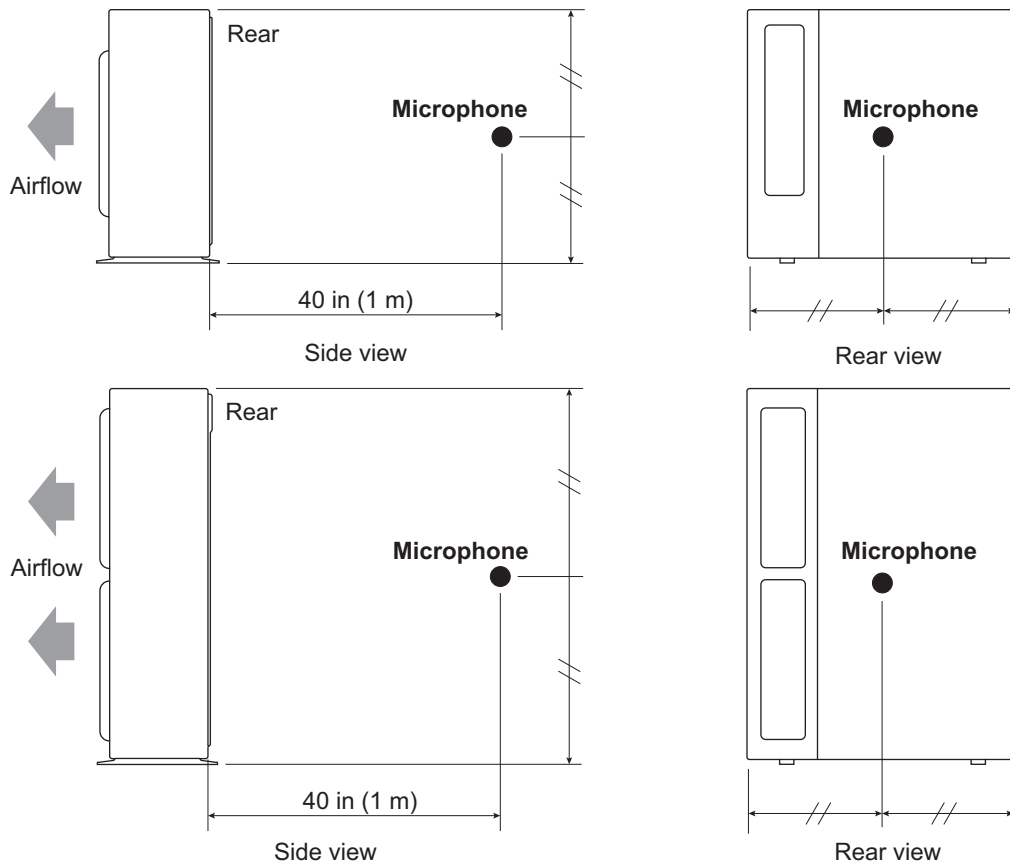

NOTE: Detailed shape of the actual outdoor unit might be slightly different from the one illustrated above.

10. Electrical characteristics

Model name			AOU12RLFC	
Power supply	Voltage	V	208/230~	
	Frequency	Hz	60	
MCA *1		A	13.4	
Starting current		A	6.7	
Wiring spec. *2	MAX. CKT. BKR *3		A	15
	Power cable		AWG	14
	Connection cable *4	Size	AWG	14
		Limited wiring length	ft (m)	60 (18)

Item	Unit	Model name				
		AOU18RGLX	AOU24RGLX	AOU30RGLX	AOU36RGLX	
Power supply	Voltage	V	208/230~			
	Frequency	Hz	60			
MCA *1		A	18.3	20.8	24.6	
Starting current		A	6.6	9.6	11.5	16.1
Wiring spec. *2	MAX. CKT. BKR *3		A	20	30	
	Power cable		AWG	16—14		
	Connection cable *4	Size	AWG	20—16		
		Limited wiring length	ft (m)	167 (51)		

Item	Unit	Model name		
		AOU42RGLX	AOU48RGLX	
Power supply	Voltage	V	208/230~	
	Frequency	Hz	60	
MCA *1		A	25.2	28.3
Starting current		A	16.8	20.9
Wiring spec. *2	MAX. CKT. BKR *3		A	30
	Power cable		AWG	14—10
	Connection cable *4	Size	AWG	18—16
		Limited wiring length	ft (m)	250 (76)

*1: Minimum Circuit Ampacity (Calculation based on UL1995)

*2: Selected sample based on Japan Electrotechnical Standards and Codes Committee E0005. As the regulations of wire size and circuit breaker differ in each country or region, select appropriate devices complied to the regional standard.

*3: Maximum Circuit Breaker

*4: Limit voltage drop to less than 2%. If voltage drop is 2% or more, increase cable conductor size.

11. Safety devices

Type of protection	Protection form		Model	
			AOU12RLFC	
Circuit protection	Current fuse (Near the terminal)		250 V, 20 A	
			250 V, 5 A	
	Current fuse (Main PCB)		250 V, 15 A	
			250 V, 3.15 A	
Fan motor protection	Thermal protection program	Activate	212±27 °F (100±15 °C) Fan motor stop	
		Reset	203±18 °F (95±10 °C) Fan motor restart	
Compressor protection	Thermal protection program (Discharge temp.)	Activate	230 °F (110 °C) Compressor stop	
		Reset	After 7 minutes Compressor restart	
	Thermal protection program (Outdoor temp.) (Only in COOL mode)	Activate	5 °F (-15 °C) Compressor stop	
		Reset	14 °F (-10 °C) Compressor restart	

Type of protection	Protection form		Model			
			AOU18RGLX	AOU24RGLX	AOU30RGLX	AOU36RGLX
Circuit protection	Current fuse (Filter PCB)		250 V, 5 A × 2			
	Current fuse (Main PCB)		250 V, 3.15 A × 2			
Fan motor protection	Thermal protection	Activate	302 ⁺²⁷ ₋₁₈ °F (150 ⁺¹⁵ ₋₁₀ °C) Fan motor stop			
		Reset	248 ⁺²⁷ ₋₁₈ °F (120 ⁺¹⁵ ₋₁₀ °C) Fan motor restart			
Compressor protection	Terminal protection program (Compressor temp.)	Activate	226 °F (108 °C) Compressor stop			
		Reset	176 °F (80 °C) Compressor restart			
	Thermal protection program (Discharge temp.) (COOL or DRY mode)	Activate	230 °F (110 °C) Compressor stop			
		Reset	After 7 minutes Compressor restart			
	Thermal protection program (Outdoor temp.)	Activate	—			
		Reset	—			
High pressure protection	Pressure switch	Activate	4.2±0.1 MPa Compressor stop			
		Reset	3.2±0.15 MPa Compressor restart			

Type of protection	Protection form		Model		
			AOU42RGLX	AOU48RGLX	
Circuit protection	Current fuse (Filter PCB)		250 V, 30 A 250 V, 10 A × 2 250 V, 5 A		
	Current fuse (Main PCB)		250 V, 3.15 A		
Fan motor protection	Thermal protection	Activate	252±16°F (122±9 °C) Fan motor stop		
		Reset	241±16°F (116±9 °C) Fan motor restart		
Compressor protection	Terminal protection program (Compressor temp.)	Activate	226 °F (108 °C) Compressor stop		
		Reset	After 40 minutes Compressor restart		
	Thermal protection program (Discharge temp.)	Activate	110°C Compressor stop		
		Reset	After 7 minutes Compressor restart		
	Thermal protection program (Outdoor temp.)	Activate	—		
		Reset	—		
High pressure protection	Thermal protection program (Heat exchanger temp.)	Cooling	Activate	154 °F (68 °C) Compressor stop	
			Reset	145°F (63 °C) Compressor restart	
	Pressure sensor	Heating	Activate	4.1 MPa Compressor stop	
			Reset	After 3 minutes Compressor restart	
Low pressure protection	Pressure sensor	Cooling	Activate	0.12 MPa or less (for 5 minutes) Compressor stop	
			Reset	After 7 minutes Compressor restart	

12. External input and output (For AOU42RGLX and AOU48RGLX)

With using external input and output functions, this product can be operated inter-connectedly with an external device.

Connector	Input	Output	Remarks
CN10	Low noise mode	—	See external input/output settings for details.
CN11	Peak cut mode	—	
CN12	—	Error status	
CN13	—	Compressor status	

12-1. External input

With using external input function, on/off status of “Low noise mode” and “Peak cut mode” can be specified by the external signal.

■ Low noise mode

In following condition, the operating noise of the outdoor unit reduces comparing from the one in normal operating condition:

The air conditioner is set to the “Low noise mode” when closing the contact input of a commercial timer or on/off switch to a connector on the control PCB of the outdoor unit.

NOTE: Product performance may drop depending on some conditions such as the outdoor temperature.

• Circuit diagram example

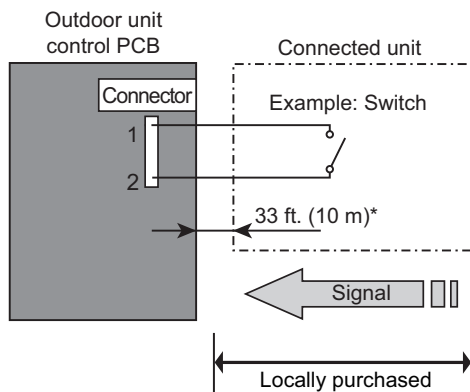

- Contact capacity: DC 24 V or more, 10 mA or more.
- *: Make the distance from the PCB to the connected unit within 33 ft (10 m).
- Construct a circuit as shown in this figure with using optional parts mentioned below.
- Input signal: On in “Low noise mode”
- Input signal: Off in normal operation
- To set the level of “Low noise mode”, refer to "[Low noise mode](#)" on page 141.

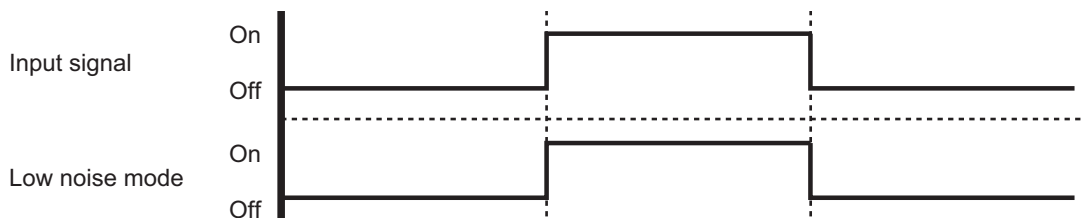

• Optional part

Part name	Model name	Exterior
External connect kit	UTY-XWZXZ3	External input wire 

■ Peak cut mode

By performing following on-site work, operation that suppresses the current value can be enabled: The air conditioner is set to the “Peak cut mode” when closing the contact input of a commercial timer or on/off switch to a connector on the control PCB of the outdoor unit.

• Circuit diagram example

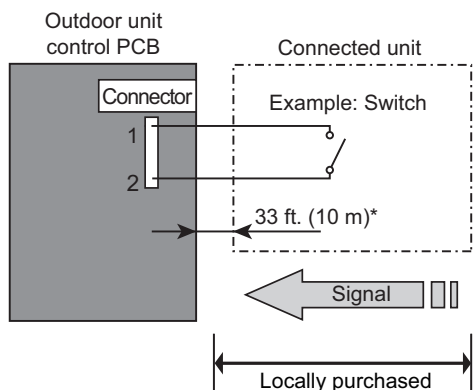

- Contact capacity: DC 24 V or more, 10 mA or more.
- *: Make the distance from the PCB to the connected unit within 33 ft (10 m).
- Construct a circuit as shown in this figure with using optional parts mentioned below.
- Input signal: On in “Peak cut mode”
- Input signal: Off in normal operation
- To set the level of “Peak cut mode”, refer to ["Peak cut mode"](#) on page 142.

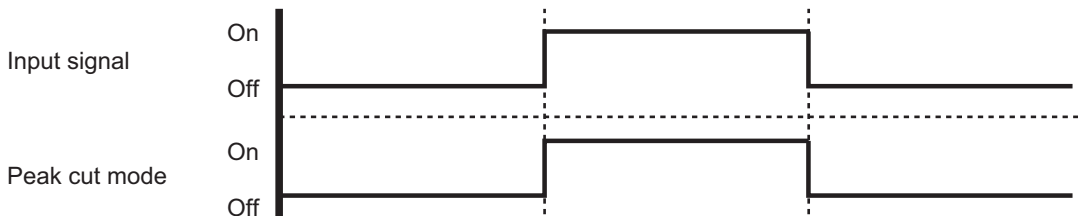

• Optional part

Part name	Model name	Exterior
External connect kit	UTY-XWZXZ3	External input wire

OUTDOOR UNIT
AOU12-48R

OUTDOOR UNIT
AOU12-48R

12-2. External output

With using external output function, some status signals are transmitted to the control PCB, and the related LED lamp indicates the status of this product.

■ Error status output

Signal on air conditioner error status is generated when a malfunction occurs.

- **Circuit diagram example**

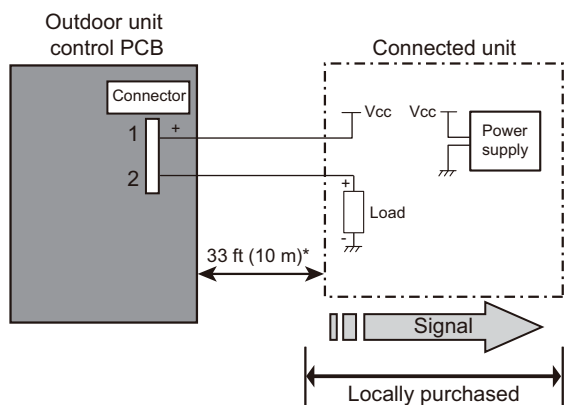

- 1: Power supply
Voltage (Vcc): DC 24 V or less
- 2: Load
DC 500 mA or less
- *: Make the distance from the PCB to the connected unit within 33 ft (10 m).

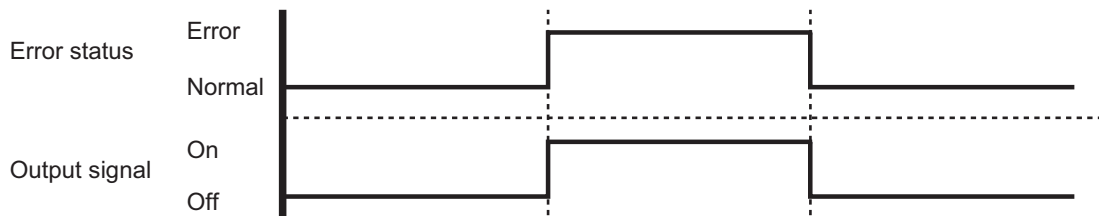

- **Optional part**

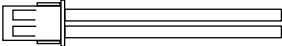
Part name	Model name	Exterior
External connect kit	UTY-XWZXZ3	External output wire 

OUTDOOR UNIT
AOU12-48R

OUTDOOR UNIT
AOU12-48R

Compressor status output

Signal on compressor operation status is generated when the compressor is running.

Circuit diagram example

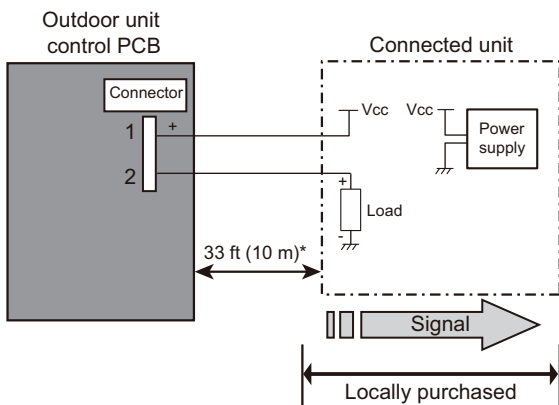

- 1: Power supply
Voltage (Vcc): DC 24 V or less
- 2: Load
DC 500 mA or less
- *: Make the distance from the PCB to the connected unit within 33 ft (10 m).

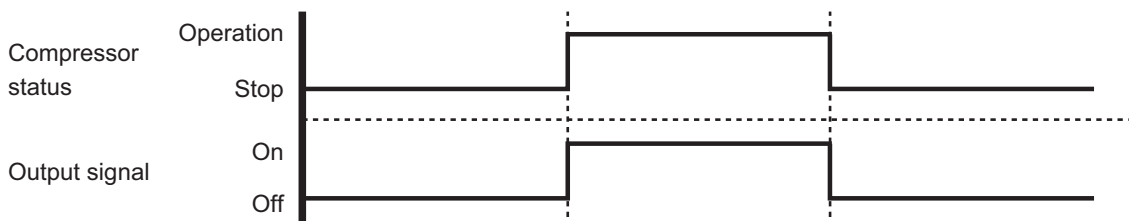

Optional part

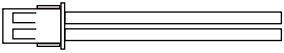
Part name	Model name	Exterior
External connect kit	UTY-XWZXZ3	External output wire 

13. Function settings (For AOU42RGLX and AOU48RGLX)

Perform appropriate function setting locally according to the installation environment.

NOTE: Incorrect settings can cause a product malfunction.

⚠ CAUTION

- Before setting up the switch buttons, discharge the static electricity from your body.
- Never touch the terminals or the patterns on the parts that are mounted on the PCB.

13-1. Local setting switch buttons

■ Control PCB and switch buttons location

Control PCB of the outdoor unit is located as shown in the following figure.

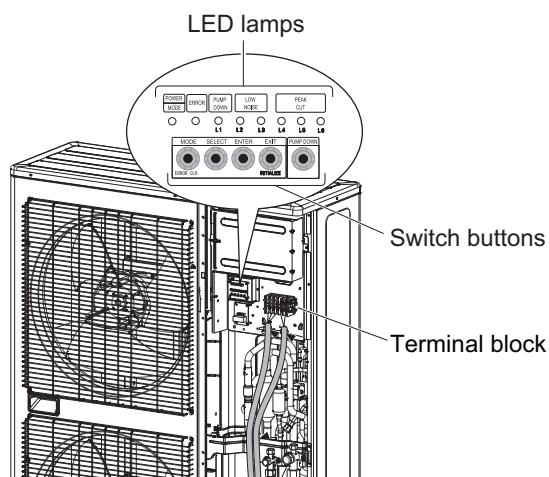

Switch buttons and the functions

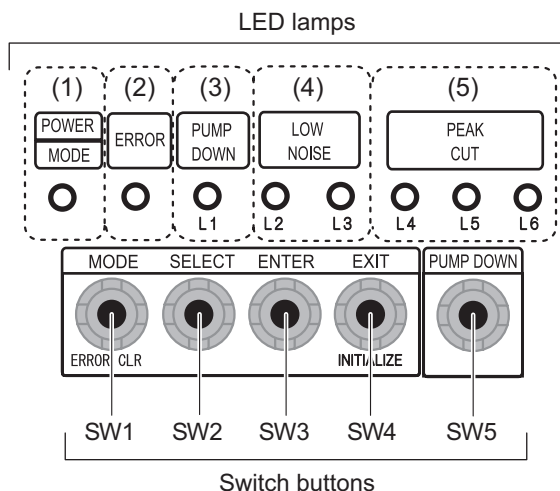

LED lamp			Function or operation method
(1)	POWER/MODE	Green	Lights on while power on. Local setting in outdoor unit or error code is displayed with blink.
(2)	ERROR	Red	Blinks during error operation.
(3)	PUMP DOWN (L1)	Orange	Lights on during pump down operation.
(4)	LOW NOISE MODE (L2 and L3)	Orange	Lights on during "Low noise mode" when local setting is activated. (Lighting pattern of L2 and L3 indicates low noise level.)
(5)	PEAK CUT MODE (L4, L5, and L6)	Orange	Lights on during "Peak cut mode" when local setting is activated. (Lighting pattern of L4, L5, and L6 indicates peak cut level.)

Switch button		Function or operation method
SW1	MODE	Switches between "Local setting" and "Error code display".
SW2	SELECT	Switches between the individual "Local settings" and the "Error code displays".
SW3	ENTER	Switches between the individual "Local settings" and the "Error code displays".
SW4	EXIT	Returns to "Operation status display".
SW5	PUMP DOWN	Starts the pump down operation.

13-2. Local setting procedure

NOTE: Before performing the function setting, be sure to stop the operation of the air conditioner.

Low noise mode

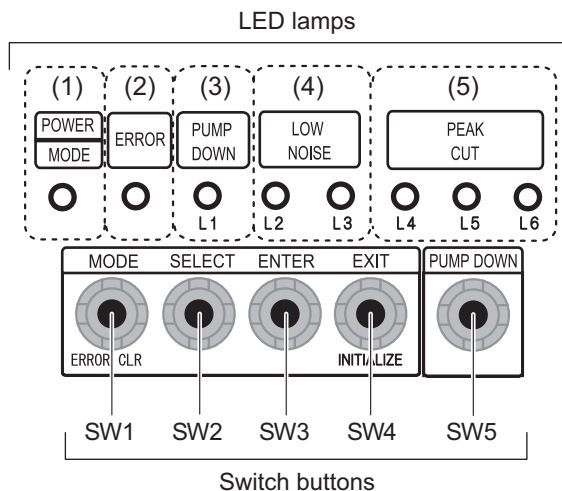

1. Press the MODE switch button (SW1) for 3 seconds or more to switch to "Local setting mode".
2. After confirming the LED lamp of POWER/MODE blinks 9 times, press the ENTER switch button (SW3).

POWER MODE	ERROR	PUMP DOWN (L1)	LOW NOISE (L2) (L3)		PEAK CUT (L4) (L5) (L6)		
Blinks (9 times)	○	○	○	○	○	○	○

Sign "○": Lights off

3. Press the SELECT switch button (SW2), and adjust the LED lamp as shown below. Then the LED lamp indicates the current setting.

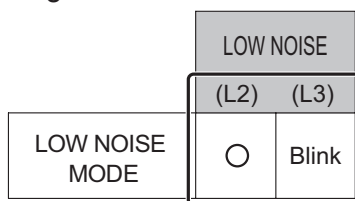

4. Press the ENTER switch button (SW3).

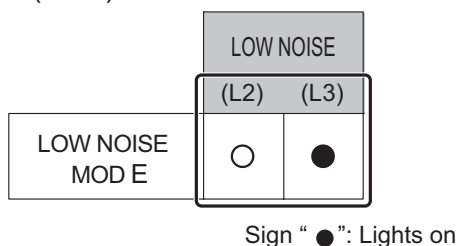

5. Press the SELECT switch button (SW2), and adjust the LED lamps as shown below.

	PEAK CUT (L4) (L5) (L6)		
MODE 1: Low	○	○	Blink
MODE 2: Lower	○	Blink	○

- Press the ENTER switch button (SW3) and fix it.

	PEAK CUT		
	(L4)	(L5)	(L6)
MODE 1: Low	○	○	●
MODE 2: Lower	○	●	○

- To return to “Operating status display (Normal operation)”, press the EXIT switch button (SW4).

In case of missing how many times you pressed the SELECT and ENTER switch buttons:

- To return to “Operation status display (Normal operation)”, press the EXIT switch button once.
- Restart from the beginning of setting procedure.

NOTE: In case of missing how many times you pressed the SELECT and ENTER switch buttons, you must redo the setting procedure. Return to “Operation status display (Normal operation)” by pressing the EXIT switch button once, and restart from the beginning of the setting procedure.

■ Peak cut mode

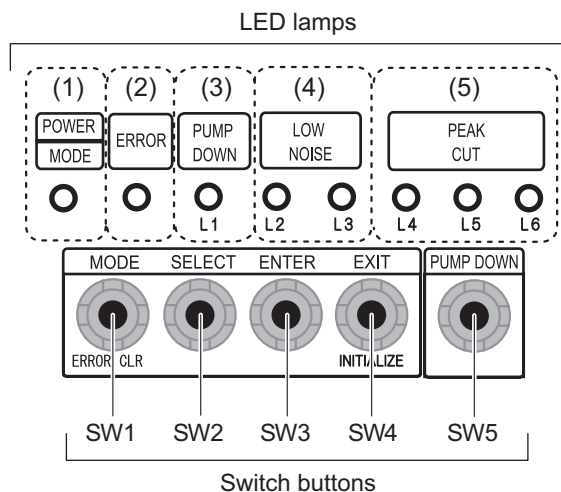

- Press the MODE switch button (SW1) for 3 seconds or more to switch to “Local setting mode”.
- After confirming the LED lamp of POWER/MODE blinks 9 times, press the ENTER switch button (SW3).

POWER	ERROR	PUMP DOWN (L1)	LOW NOISE		PEAK CUT		
MODE			(L2)	(L3)	(L4)	(L5)	(L6)
Blinks (9 times)	○	○	○	○	○	○	○

Sign “○”: Lights off

- Press the SELECT switch button (SW2), and adjust the LED lamp as shown below. Then the LED lamp indicates the current setting.

	LOW NOISE	
	(L2)	(L3)
PEAK CUT MODE	Blink	○

4. Press the ENTER switch button (SW3).

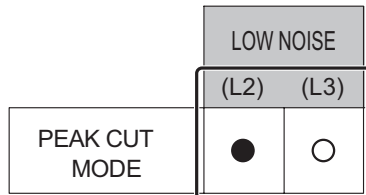

Sign " ● ": Lights on

5. Press the SELECT switch button (SW2), and adjust the LED lamps as shown below.

	PEAK CUT		
	(L4)	(L5)	(L6)
100 % of rated input ratio	○	○	Blink
75 % of rated input ratio	○	Blink	○
50 % of rated input ratio	○	Blink	Blink
0 % of rated input ratio	Blink	○	○

6. Press the ENTER switch button (SW3) and fix it.



	PEAK CUT		
	(L4)	(L5)	(L6)
100 % of rated input ratio	○	○	●
75 % of rated input ratio	○	●	○
50 % of rated input ratio	○	●	●
0 % of rated input ratio	●	○	○

7. To return to "Operating status display (Normal operation)", press the EXIT switch button (SW4).



NOTE: When pressed number is lost during setting, you must redo the setting procedure. Return to "Operation status display (Normal operation)" by pressing the EXIT switch button once, and restart from the beginning of the setting procedure.

14. Accessories



14-1. Model: AOU12RLFC

Part name	Exterior	Q'ty	Part name	Exterior	Q'ty
Installation manual		1	Drain cap		3
Drain pipe		1			

14-2. Models: AOU18RGLX, AOU24RGLX, AOU30RGLX, and AOU36RGLX

Part name	Exterior	Q'ty	Part name	Exterior	Q'ty
Installation manual		1	Drain cap		5
Drain pipe		1			

14-3. Models: AOU42RGLX and AOU48RGLX

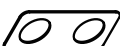
Part name	Exterior	Q'ty	Part name	Exterior	Q'ty
Installation manual		1	Drain cap		5
Drain pipe		1	Conduit plate		1

15. Optional parts

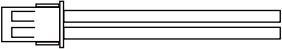
Exterior	Part name	Model name	Summary
	External connect kit	UTY-XWZXZ3	Use to operate the external input and output functions of outdoor unit. (For 42 and 48 models)