

AIR CONDITIONER  
**Wall Mounted type**



# DESIGN & TECHNICAL MANUAL

---

---

INDOOR



ASU18RLB  
ASU24RLB  
ASU30RLXB  
ASU36RLXB

---

OUTDOOR



AOU18RLB  
AOU24RLB



AOU30RLXB  
AOU36RLXB

---

**FUJITSU GENERAL LIMITED**

# **1. INDOOR UNIT**

---

**WALL MOUNTED TYPE :**

**ASU18RLB**

**ASU24RLB**

**ASU30RLXB**

**ASU36RLXB**

# CONTENTS

---

## 1. INDOOR UNIT

---

<b>1. FEATURE</b> .....	01 - 01
<b>2. WIRELESS REMOTE CONTROLLER</b> .....	01 - 04
<b>3. SPECIFICATIONS</b> .....	01 - 06
<b>4. DIMENSIONS</b> .....	01 - 07
<b>5. WIRING DIAGRAMS</b> .....	01 - 09
<b>6. CAPACITY TABLE</b> .....	01 - 10
6-1. COOLING CAPACITY.....	01 - 10
6-2. HEATING CAPACITY .....	01 - 14
<b>7. FAN PERFORMANCE</b> .....	01 - 16
7-1. AIR VELOCITY DISTRIBUTION.....	01 - 16
7-2. AIR FLOW .....	01 - 20
<b>8. OPERATION NOISE</b> .....	01 - 24
8-1. NOISE LEVEL CURVE .....	01 - 24
8-2. SOUND LEVEL CHECK POINT .....	01 - 26
<b>9. SAFETY DEVICES</b> .....	01 - 27
<b>10. EXTERNAL INPUT &amp; OUTPUT</b> .....	01 - 28
10-1. EXTERNAL INPUT .....	01 - 28
10-2. EXTERNAL OUTPUT .....	01 - 30
<b>11. FUNCTION SETTING</b> .....	01 - 31
11-1. INDOOR UNIT (Setting by remote controller).....	01 - 31
<b>12. OPTIONAL PARTS</b> .....	01 - 36

# 1. FEATURE

- **MODEL**  
ASU18RLB  
ASU24RLB  
ASU30RLXB  
ASU36RLXB



## ■ FEATURES

### ● High energy performance

		MODEL			
		ASU18RLB	ASU24RLB	ASU30RLXB	ASU36RLXB
Seasonal Energy Efficiency Ratio (SEER)	Btu/hW	19.0	18.0	16.5	15.5
Heating Seasonal Performance Factor (HSPF)		10.6		9.0	
Energy Efficient Ratio (EER)		12.5	10.0	9.5	8.5

MEASUREMENT CONDITIONS  
ANSI/ASHRAE STANDARD 37-1988

### ● ALL DC

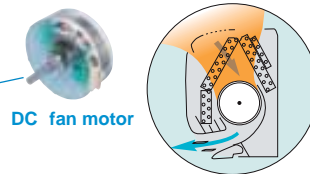

**High efficiency layout**  
Large air flow and quiet operation by new air flow path

- a DC fan motor
- b DC twin rotary compressor  
More compact compared with conventional model

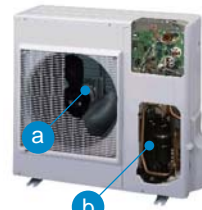

Front view

### ● Super quiet

Air flow mode can be set in 4 steps and more detailed air flow setting is possible.

### ● Easy maintenance

Easy maintenance and always clean. Troublesome maintenance has been made easy.  
Since the front panel is easy to remove, maintenance is also easy.

### ● MIN. HEAT Operation

The room temperature can be set to go no lower than 50°F, thus ensuring that the room does not get too cold when not occupied

Caution)

- When the room temperature is higher than 50°F, "MIN. HEAT" operation does not start. Operation starts and maintains the room temperature at 50°F when the temperature drops below 50°F.

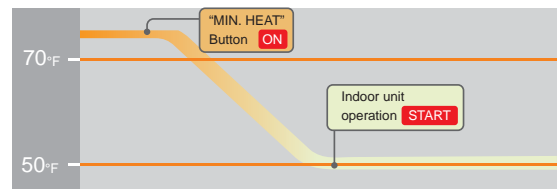
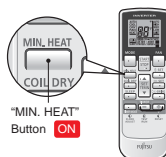

## ● Power diffuser

Adoption of large power diffuser

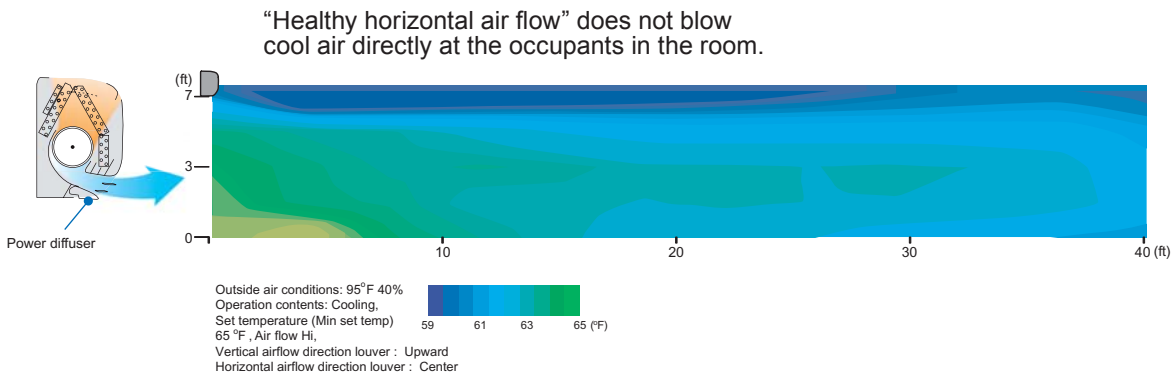
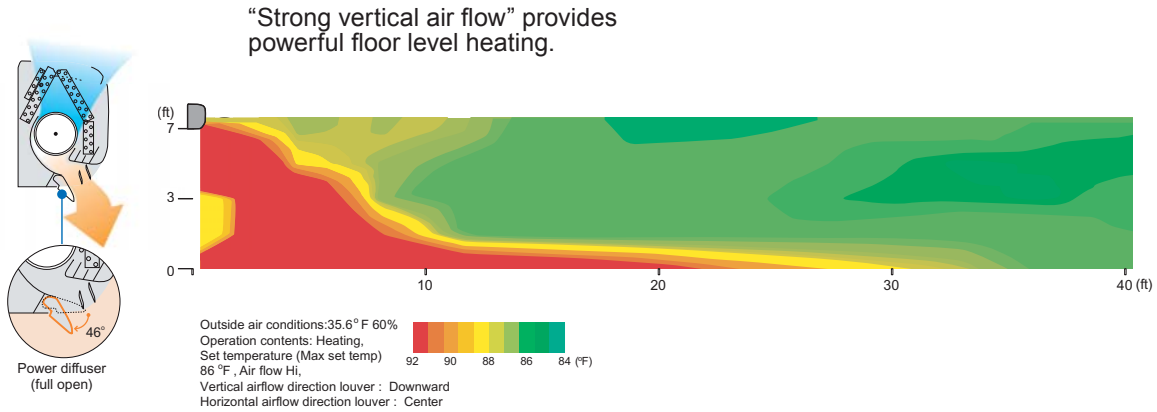

## ● Low ambient outdoor temperature design

Cooling	14 to 115	°F
Heating	5 to 75	

## ● Corresponds to long piping

18, 24 Model	65 (20)	ft. (m)
30, 36 Model	164 (50)	

## ● Air conditioner filter features

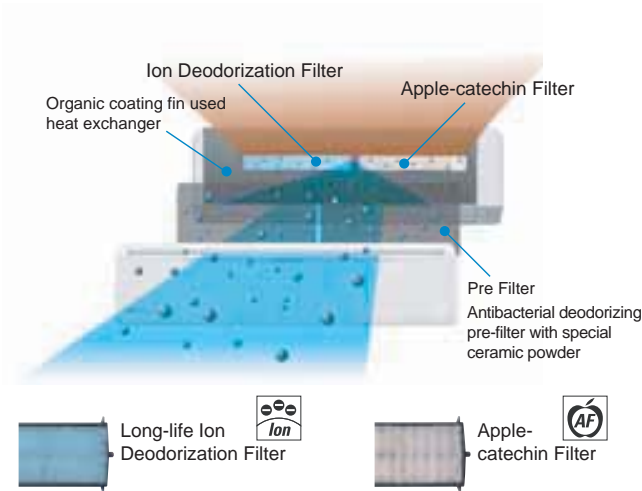

## ● Economy operation

Example : Cooling operation

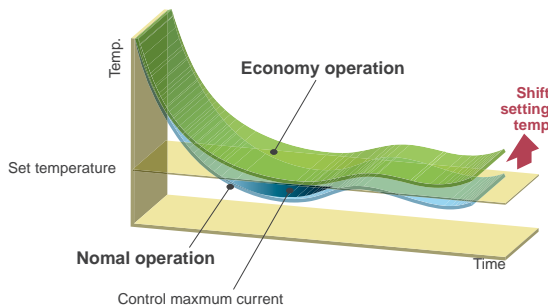

- Economy operation is energy saving, as the set temperature of indoor unit is shifted by 2°F and the maximum electric value of the outdoor unit is suppressed.

## ● Blue fin heat exchanger (30, 36 Model)

Corrosion-resistance of the heat exchanger even in coastal areas has been improved by blue fin treatment of the outdoor unit heat exchanger.



## 2. WIRELESS REMOTE CONTROLLER

### FEATURES



- Four kinds of timer setup (ON / OFF / PROGRAM / SLEEP) are possible.
- Can be used jointly with wired remote controllers .
- Easy to change custom code (max. 4 custom codes) by button operation.

#### ● Built-in timers

Select from four different timer programs (On / Off / Program / Sleep).

#### ● Program timer

The program timer operates the ON and OFF timer once within a 24 hour period.

#### ● Sleep timer

The sleep timer function automatically corrects the temperature thermostat setting according to the time setting to prevent excessive cooling and heating while sleeping.

##### Cooling operation / dry operation

When the sleep timer is set, the set temperature automatically rises 2°F (1°C) every hour. The set temperature can rise up to a maximum of 4°F (2°C).

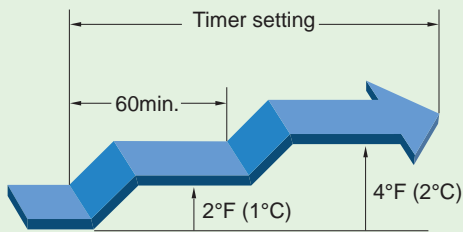

##### Heating operation

When the sleep timer is set, the set temperature automatically drops 2°F (1°C) every 30 minutes. The set temperature can drop to a maximum of 8°F (4°C).

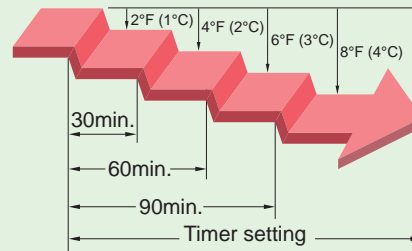

#### ● Simple function setting

Setting of the air conditioner selection function is performed by remote controller.

#### ● Switching remote controller custom code

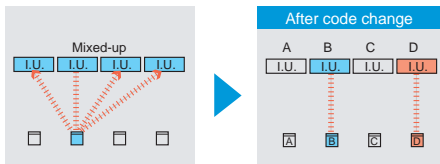

- Code selector switch eliminates unit being wrongly switched. (Up to 4 codes can be set.)

\*I.U.=Indoor unit

## FUNCTIONS

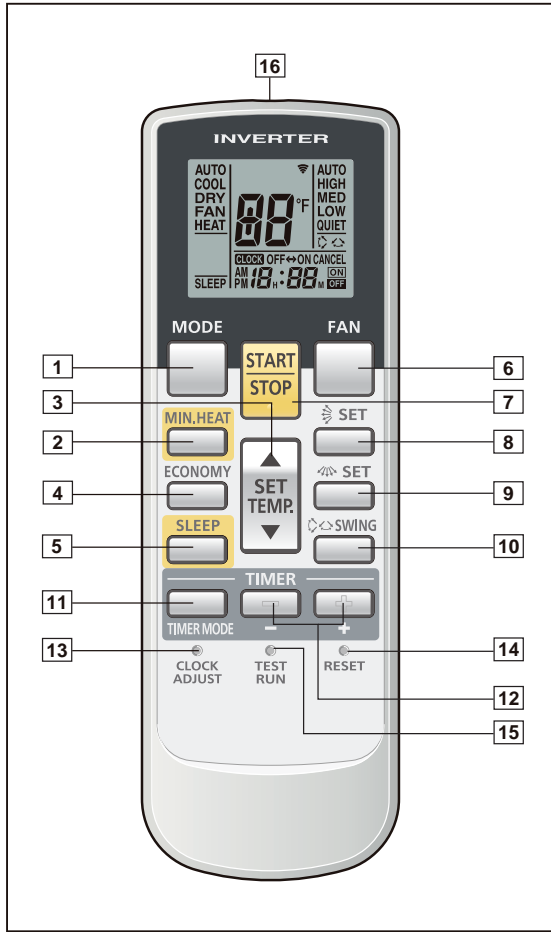

Display panel

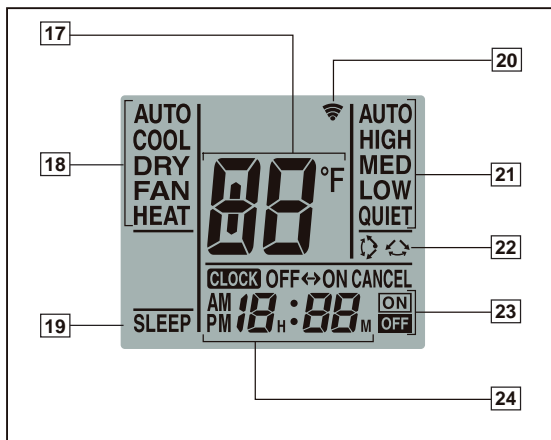

- 1 **MODE button**  
Selects the operating mode (AUTO, COOL, DRY, FAN, HEAT).  
/Start / end R.C. custom code change. (Max 4 types)
- 2 **MIN.HEAT button**
- 3 **SET TEMP. button (▲/▼)**  
Set remote controller custom code buttons  
Sets the indoor temp./ Sets R.C. custom code.
- 4 **ECONOMY button**
- 5 **SLEEP button**  
Pressed to select sleep timer.
- 6 **FAN button**  
Selects the fan speed (AUTO, HIGH, MED, LOW, QUIET).
- 7 **START/STOP button**  
Pressed to start and stop operation.
- 8 **SET button (Vertical)**  
Air flow direction vertical set button.
- 9 **SET button (Horizontal)**  
Air flow direction horizontal set button.
- 10 **SWING button**  
Air flow direction swing button.
- 11 **TIMER MODE button**  
Pressed to select the timer mode. (OFF TIMER, ON TIMER, PROGRAM TIMER, TIMER RESET)
- 12 **TIMER SET ( + / - ) button**  
Sets the current time and on-off time.
- 13 **CLOCK ADJUST button**  
Sets the current time.
- 14 **RESET button**  
Used when replacing batteries.
- 15 **TEST RUN button**  
Used when testing the air conditioner after installation.
- 16 **Signal transmitter**
- 17 **Temperature indicator**
- 18 **Mode indicator**
- 19 **Sleep indicator**
- 20 **Transmit indicator**
- 21 **Fan speed indicator**
- 22 **Swing indicator**
- 23 **Timer mode indicator**
- 24 **Clock indicator**

Note: Functions will be different due to type of indoor unit.  
For details, please see operation manual.



### 3. SPECIFICATIONS

Type				WALL MOUNTED					
				INVERTER HEAT PUMP					
Model name				ASU18RLB	ASU24RLB	ASU30RLXB	ASU36RLXB		
Power source				208/230V ~ 60Hz					
Available voltage range				187-253V					
Capacity	Cooling	Rated	kW	5.28	7.03	8.79	9.70		
			Btu/h	18,000	24,000	30,000	33,000		
		Min-Max	kW	0.90 - 5.28	0.90 - 7.30	2.90 - 9.50	2.90 - 10.00		
	Heating	Rated	Btu/h	3,100 - 19,000	3,100 - 25,000	9,900 - 32,400	9,900 - 34,100		
			kW	5.28	7.03	8.79	9.96		
		Min-Max	Btu/h	18,000	24,000	30,000	34,000		
Input power	Cooling	Rated	kW	1.44	2.40	3.16	3.88		
				Max	1.63	2.50	3.42	4.01	
		Heating	Rated	1.285	1.925	2.80	3.39		
	Max		2.06	2.54	3.28	3.50			
	Current	Cooling	Rated	A	6.4	10.5	13.8	17.0	
		Heating			5.8	8.5	12.3	14.8	
EER	Cooling		kW/kW	3.67	2.93	2.78	2.50		
			Btu/hW	12.5	10.0	9.5	8.5		
COP	Heating		kW/kW	4.11	3.65	3.14	2.94		
			Btu/hW	14.0	12.5	10.7	10.0		
SEER	Cooling		Btu/hW	19.0	18.0	16.5	15.5		
HSPF	Heating		Btu/hW	10.6	10.6	9.0	9.0		
POWER FACTOR	Cooling		%	98	99	99	99		
	Heating			96	98	99	99		
Moisture removal			pints/h (l/h)	4.0 (1.9)	6.3 (3.0)	9.7 (4.6)	10.1 (4.8)		
Maximum operating current *1			Cooling	A	8.3	11.8	16.8		
			Heating		11.8	13.8	18.8		
Fan	Airflow rate	Cooling	High	CFM (m <sup>3</sup> /h)	541 (920)	659 (1,120)	659 (1,120)	694 (1,180)	
			Med		435 (740)	530 (900)	530 (900)	530 (900)	
			Low		365 (620)	435 (740)	435 (740)	435 (740)	
			Quiet		306 (520)	365 (620)	365 (620)	365 (620)	
		Heating	High		541 (920)	647 (1,100)	677 (1,150)	694 (1,180)	
			Med		435 (740)	530 (900)	530 (900)	530 (900)	
			Low		365 (620)	435 (740)	435 (740)	435 (740)	
			Quiet		318 (540)	365 (620)	365 (620)	365 (620)	
		Type × Q'ty			Cross flow fan × 1				
		Motor output			W	42	42	42	65
Sound pressure level *2	Cooling	High	dB(A)	42	47	47	50		
		Med		35	41	42	42		
		Low		31	35	37	37		
		Quiet		26	31	32	32		
	Heating	High		43	47	49	50		
		Med		36	42	42	42		
		Low		33	36	37	37		
		Quiet		28	33	33	33		
Heat exchanger type	Dimensions (H × W × D)		in. (mm)	Main:14-14/16 x 32-12/16 x 1-1/16 (378×832×26.6)					
	Fin pitch		FPI	Sub: 3-5/16 x 32-12/16 x 8/16 (84×832×13.3)					
	Rows x Stages			Main:21, Sub:18					
	Pipe type			Main:2×18, Sub1:1×4, Sub2:1×4					
	Fin type			Copper					
Enclosure	Material			Aluminum					
	Color			Polystyrene					
Dimensions (H×W×D)	Net		mm	320 × 998 × 228					
			inch	12-10/16 × 39-5/16 × 9					
	Gross		mm	319 × 1090 × 429					
			inch	12-9/16 × 42-15/16 × 16-14/16					
Weight	Net		lbs. (kg)	31 (14)					
			Gross	40 (18)					
Connection pipe	Size	Liquid	in. (mm)	Ø 1/4 (Ø 6.35)		Ø 3/8 (Ø 9.52)			
		Gas		Ø 1/2 (Ø 12.70)		Ø 5/8 (Ø 15.88)			
	Method			Flare					
Operation range	Cooling		°F (°C)	64 to 90 (18 to 32)					
			%RH	80 or less					
Remote controller type	Heating		°F (°C)	88 (30) or less					
				Wireless					
Drain pipe	Material			PVC					
	Size		mm (Reference in.)	Ø12 (15/32) (I.D.) Ø16 (5/8) (O.D.)					

**NOTE :**

- Specifications are based on the following conditions.  
Cooling : Indoor temperature of 80°F (26.67°C) DB / 67°F (19.44°C) WB, and outdoor temperature of 95°F (35°C) DB / 75°F (23.9°C) WB.  
Heating : Indoor temperature of 70°F (21.11°C) DB / 59°F (15°C) WB, and outdoor temperature of 47°F (8.33°C) DB / 43°F (6.11°C) WB.  
Pipe length : 24ft.7in (7.5m), Height difference:0 m. (Outdoor unit-Indoor unit)
- The protective function might work when using it outside the operation range.

\*1: The maximum current is the maximum value when operated within the operation range.

\*2: These are the measured values in the manufacturer's anechoic chamber.  
Because of the surrounding sound environment, the sound levels measured in actual installation conditions might be higher than the specified values here.

# 4. DIMENSIONS

## ■ MODEL: ASU18RLB, ASU24RLB, ASU30RLXB, ASU36RLXB

Unit : in (mm)

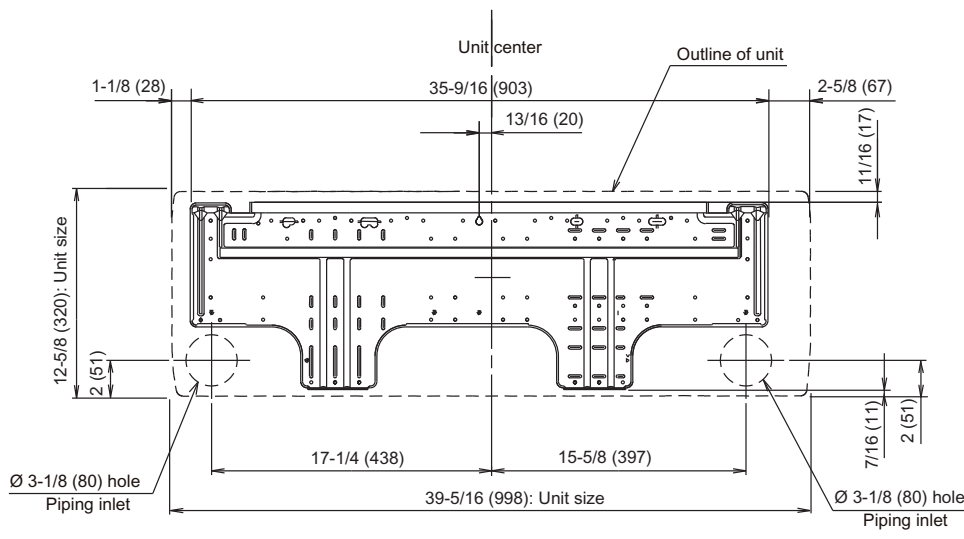
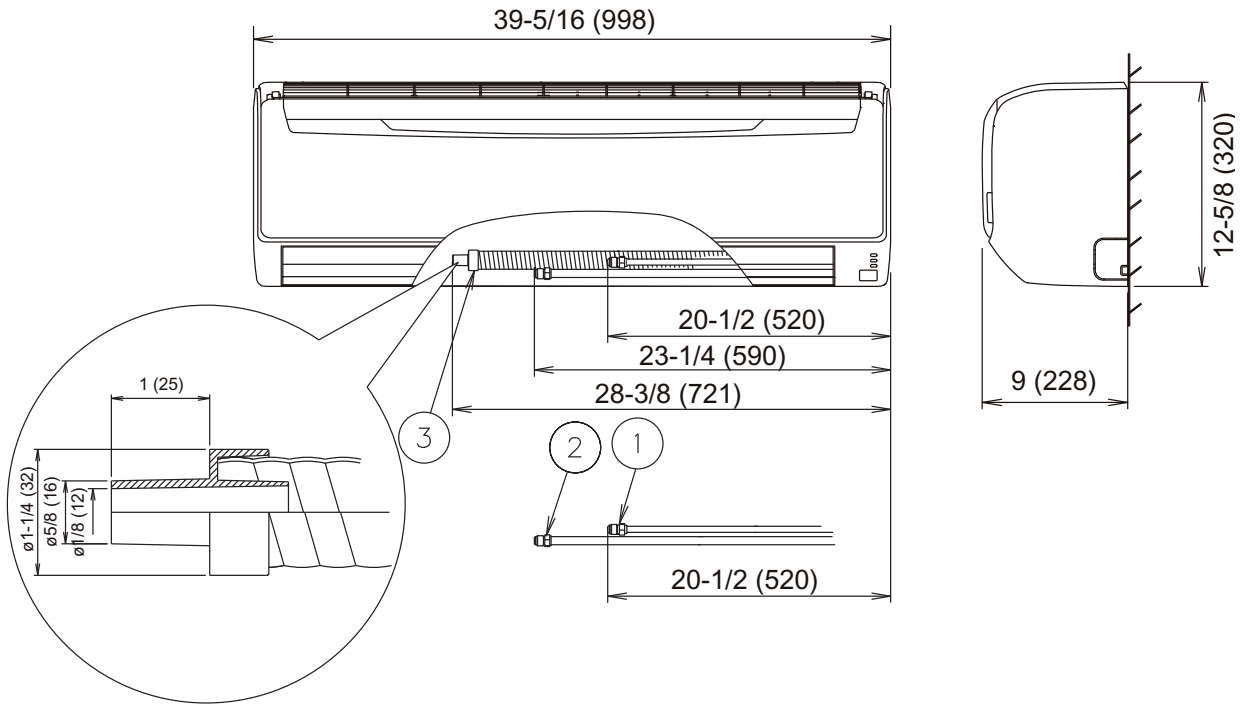

			ASU18RLB ASU24RLB	ASU30RLXB ASU36RLXB
①	Refrigerant pipe flare connection	Liquid	Ø 1/4 in. (Ø 6.35 mm)	Ø 3/8 in. (Ø 9.52 mm)
②		Gas	Ø 1/2 in. (Ø 12.70 mm)	Ø 5/8 in. (Ø 15.88 mm)
③	Drain hose connection	Drain hose	I.D. Ø 15/32 in. (Ø 12 mm), O.D. Ø 5/8 in. (Ø 16 mm) Drain hose : L=26-3/8 in. (670mm)	

# ■ INSTALLATION PLACE

Unit : in (mm)

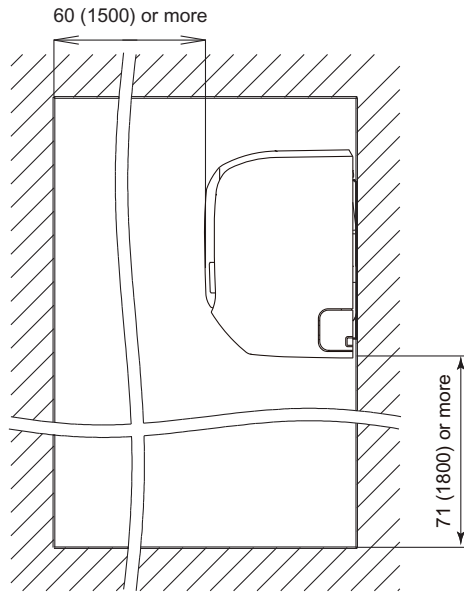
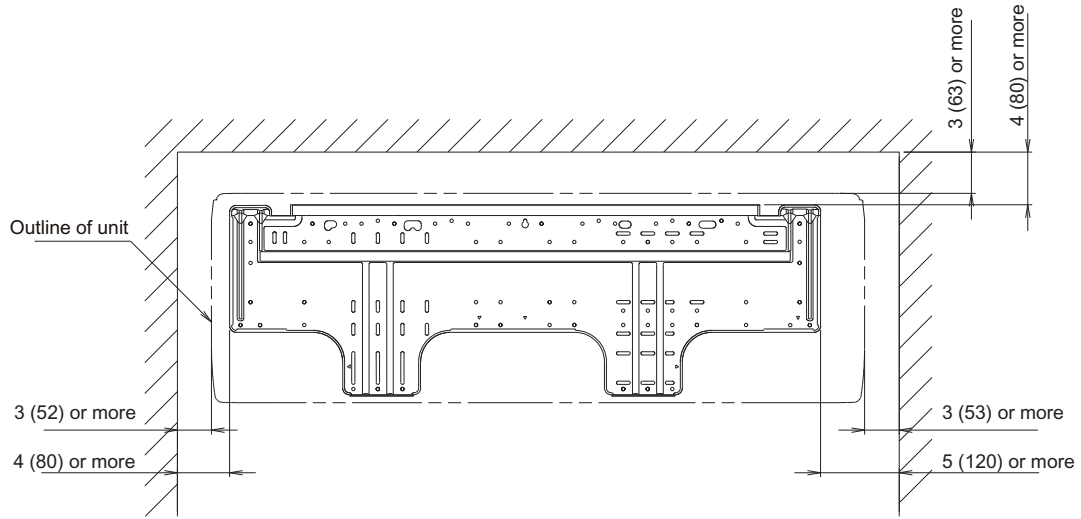

# 5. WIRING DIAGRAMS

## MODEL: ASU18RLB, ASU24RLB, ASU30RLXB, ASU36RLXB

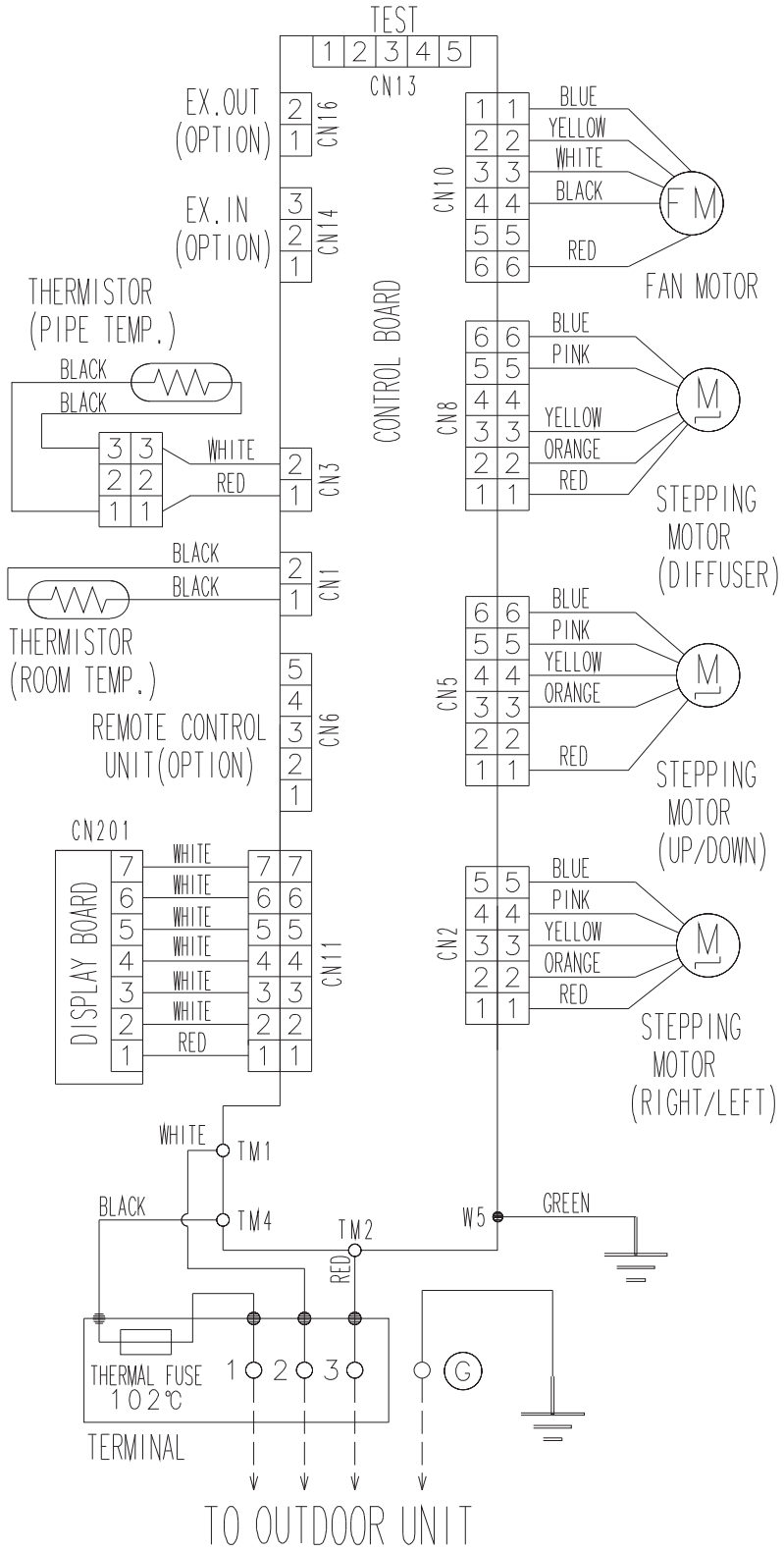

# 6. CAPACITY TABLE

## 6-1. COOLING CAPACITY

### MODEL: ASU18RLB

AFR	541
-----	-----

		Indoor temperature																	
		64°FDB			70°FDB			75°FDB			80°FDB			85°FDB			90°FDB		
		54°FWB			60°FWB			63°FWB			67°FWB			71°FWB			73°FWB		
Outdoor temperature	°FDB	TC	SHC	IP	TC	SHC	IP	TC	SHC	IP	TC	SHC	IP	TC	SHC	IP	TC	SHC	IP
	14	15.8	11.8	0.50	17.6	13.1	0.50	19.4	14.5	0.53	20.0	14.9	0.51	21.2	15.8	0.51	22.4	16.7	0.53
	23	15.5	11.6	0.54	17.3	12.9	0.54	19.1	14.2	0.57	19.7	14.6	0.56	20.8	15.5	0.56	22.0	16.4	0.58
	32	15.3	11.4	0.56	17.0	12.7	0.56	18.8	14.0	0.59	19.4	14.4	0.58	20.5	15.3	0.58	21.7	16.2	0.59
	41	15.1	11.2	0.57	16.8	12.5	0.57	18.5	13.8	0.60	19.1	14.2	0.59	20.2	15.1	0.59	21.3	15.9	0.61
	50	14.8	11.0	0.58	16.5	12.3	0.59	18.2	13.5	0.62	18.7	14.0	0.60	19.9	14.8	0.60	21.0	15.6	0.62
	59	14.6	10.8	0.62	16.2	12.1	0.62	17.9	13.3	0.66	18.4	13.7	0.64	19.5	14.5	0.64	20.7	15.4	0.66
	67	16.7	13.3	1.00	18.6	13.4	1.02	20.5	14.6	1.04	21.2	15.8	1.04	22.4	15.7	1.05	23.7	16.8	1.06
	77	16.0	12.7	1.13	17.8	12.8	1.14	19.6	13.9	1.17	20.2	15.0	1.17	21.4	15.0	1.18	22.6	16.0	1.19
	87	15.2	12.0	1.26	17.0	12.1	1.27	18.7	13.2	1.30	19.3	14.3	1.31	20.5	14.2	1.32	21.6	15.2	1.33
	95	14.2	11.3	1.39	15.8	11.4	1.42	17.4	12.4	1.43	18.0	13.4	1.44	19.1	13.3	1.45	20.2	14.2	1.46
	104	12.9	9.9	1.37	14.4	10.0	1.39	15.8	10.9	1.42	16.3	11.8	1.42	17.3	11.7	1.43	18.3	12.5	1.45
115	12.0	9.1	1.34	13.4	9.1	1.37	14.8	9.9	1.39	15.2	10.7	1.39	16.1	10.7	1.42	17.0	11.4	1.43	

AFR : Air flow rate (CFM)  
 TC : Total capacity (kBtu/h)  
 SHC : Sensible Heat capacity (kBtu/h)  
 IP : Input Power (kW)

AFR	15.3
-----	------

		Indoor temperature																	
		17.8°CDB			21.1°CDB			23.9°CDB			26.7°CDB			29.4°CDB			32.2°CDB		
		12.2°CWB			15.6°CWB			17.7°CWB			19.4°CWB			21.7°CWB			22.8°CWB		
Outdoor temperature	°CDB	TC	SHC	IP	TC	SHC	IP	TC	SHC	IP	TC	SHC	IP	TC	SHC	IP	TC	SHC	IP
	-10.0	4.63	3.45	0.50	5.16	3.85	0.50	5.69	4.24	0.53	5.86	4.37	0.51	6.20	4.62	0.51	6.56	4.89	0.53
	-5.0	4.56	3.39	0.54	5.08	3.78	0.54	5.60	4.16	0.57	5.77	4.29	0.56	6.11	4.54	0.56	6.46	4.80	0.58
	0.0	4.49	3.34	0.56	5.00	3.72	0.56	5.51	4.10	0.59	5.68	4.23	0.58	6.01	4.48	0.58	6.36	4.74	0.59
	5.0	4.41	3.29	0.57	4.92	3.67	0.57	5.42	4.04	0.60	5.59	4.16	0.59	5.92	4.41	0.59	6.25	4.66	0.61
	10.0	4.34	3.23	0.58	4.84	3.60	0.59	5.33	3.97	0.62	5.49	4.09	0.60	5.82	4.34	0.60	6.15	4.58	0.62
	15.0	4.27	3.18	0.62	4.76	3.54	0.62	5.24	3.90	0.66	5.40	4.02	0.64	5.73	4.26	0.64	6.05	4.50	0.66
	19.4	4.90	3.91	1.00	5.46	3.93	1.02	6.02	4.28	1.04	6.21	4.63	1.04	6.58	4.60	1.05	6.95	4.91	1.06
	25.0	4.68	3.72	1.13	5.21	3.75	1.14	5.75	4.08	1.17	5.92	4.40	1.17	6.27	4.39	1.18	6.63	4.68	1.19
	30.6	4.47	3.52	1.26	4.98	3.55	1.27	5.49	3.87	1.30	5.66	4.18	1.31	5.99	4.17	1.32	6.34	4.44	1.33
	35.0	4.17	3.31	1.39	4.64	3.34	1.42	5.11	3.64	1.43	5.28	3.93	1.44	5.59	3.91	1.45	5.91	4.17	1.46
	40.0	3.78	2.92	1.37	4.21	2.93	1.39	4.64	3.20	1.42	4.78	3.45	1.42	5.07	3.44	1.43	5.35	3.66	1.45
46.1	3.52	2.66	1.34	3.92	2.67	1.37	4.32	2.92	1.39	4.45	3.14	1.39	4.73	3.13	1.42	4.99	3.34	1.43	

AFR : Air flow rate (m<sup>3</sup>/min)  
 TC : Total capacity (kW)  
 SHC : Sensible Heat capacity (kW)  
 IP : Input Power (kW)

# MODEL: ASU24RLB

AFR	659
-----	-----

		Indoor temperature																	
		64°FDB			70°FDB			75°FDB			80°FDB			85°FDB			90°FDB		
		54°FWB			60°FWB			63°FWB			67°FWB			71°FWB			73°FWB		
Outdoor temperature	°FDB	TC	SHC	IP	TC	SHC	IP	TC	SHC	IP	TC	SHC	IP	TC	SHC	IP	TC	SHC	IP
	14	21.1	14.9	0.83	23.5	16.6	0.84	25.9	18.3	0.88	26.6	18.9	0.86	28.2	20.0	0.86	29.8	21.2	0.89
	23	20.7	14.7	0.90	23.1	16.3	0.90	25.5	18.0	0.95	26.2	18.6	0.93	27.8	19.7	0.93	29.4	20.8	0.96
	32	20.4	14.5	0.93	22.7	16.1	0.94	25.1	17.8	0.99	25.8	18.3	0.96	27.3	19.4	0.96	28.9	20.5	0.99
	41	20.1	14.2	0.95	22.4	15.9	0.95	24.7	17.5	1.00	25.4	18.0	0.98	26.9	19.1	0.98	28.5	20.2	1.01
	50	19.7	14.0	0.97	22.0	15.6	0.98	24.3	17.2	1.03	25.0	17.7	1.00	26.5	18.8	1.01	28.0	19.8	1.04
	59	19.7	13.7	1.04	21.9	15.3	1.04	24.2	16.9	1.10	24.9	17.4	1.07	26.4	18.4	1.07	27.9	19.5	1.10
	67	22.3	16.9	1.67	24.8	17.0	1.71	27.4	18.5	1.73	28.2	20.0	1.73	29.9	19.9	1.75	31.6	21.3	1.77
	77	21.3	16.1	1.88	23.7	16.2	1.90	26.1	17.7	1.94	26.9	19.1	1.94	28.5	19.0	1.96	30.2	20.2	1.98
	87	20.2	15.3	2.10	22.5	15.4	2.12	24.8	16.8	2.16	25.5	18.1	2.18	27.0	18.0	2.20	28.6	19.2	2.22
	95	19.0	14.3	2.32	21.1	14.4	2.36	23.3	15.7	2.38	24.0	17.0	2.40	25.4	16.9	2.42	26.9	18.0	2.44
	104	17.1	12.6	2.28	19.1	12.7	2.32	21.0	13.9	2.36	21.6	14.9	2.36	22.9	14.9	2.38	24.2	15.8	2.42
115	16.1	11.5	2.24	17.9	11.5	2.28	19.7	12.6	2.32	20.3	13.6	2.32	21.6	13.5	2.36	22.7	14.4	2.38	

AFR : Air flow rate (CFM)  
 TC : Total capacity (kBtu/h)  
 SHC : Sensible Heat capacity (kBtu/h)  
 IP : Input Power (kW)

AFR	18.7
-----	------

		Indoor temperature																	
		17.8°CDB			21.1°CDB			23.9°CDB			26.7°CDB			29.4°CDB			32.2°CDB		
		12.2°CWB			15.6°CWB			17.7°CWB			19.4°CWB			21.7°CWB			22.8°CWB		
Outdoor temperature	°CDB	TC	SHC	IP	TC	SHC	IP	TC	SHC	IP	TC	SHC	IP	TC	SHC	IP	TC	SHC	IP
	-10.0	6.17	4.38	0.83	6.88	4.88	0.84	7.58	5.38	0.88	7.81	5.54	0.86	8.27	5.87	0.86	8.74	6.20	0.89
	-5.0	6.08	4.30	0.90	6.77	4.79	0.90	7.46	5.28	0.95	7.69	5.44	0.93	8.14	5.76	0.93	8.61	6.09	0.96
	0.0	5.98	4.24	0.93	6.66	4.72	0.94	7.34	5.21	0.99	7.57	5.37	0.96	8.02	5.68	0.96	8.47	6.01	0.99
	5.0	5.88	4.17	0.95	6.55	4.65	0.95	7.23	5.12	1.00	7.45	5.28	0.98	7.89	5.60	0.98	8.34	5.91	1.01
	10.0	5.79	4.10	0.97	6.45	4.57	0.98	7.11	5.04	1.03	7.33	5.19	1.00	7.76	5.50	1.01	8.20	5.81	1.04
	15.0	5.77	4.03	1.04	6.43	4.49	1.04	7.09	4.95	1.10	7.31	5.10	1.07	7.75	5.40	1.07	8.19	5.71	1.10
	19.4	6.54	4.96	1.67	7.28	4.99	1.71	8.03	5.43	1.73	8.28	5.87	1.73	8.77	5.84	1.75	9.27	6.23	1.77
	25.0	6.24	4.72	1.88	6.95	4.75	1.90	7.66	5.18	1.94	7.89	5.59	1.94	8.36	5.57	1.96	8.84	5.93	1.98
	30.6	5.91	4.47	2.10	6.59	4.50	2.12	7.27	4.91	2.16	7.48	5.30	2.18	7.93	5.29	2.20	8.39	5.63	2.22
	35.0	5.56	4.20	2.32	6.19	4.23	2.36	6.82	4.61	2.38	7.03	4.99	2.40	7.45	4.96	2.42	7.88	5.29	2.44
	40.0	5.01	3.70	2.28	5.58	3.71	2.32	6.14	4.06	2.36	6.33	4.38	2.36	6.72	4.36	2.38	7.09	4.64	2.42
46.1	4.71	3.37	2.24	5.23	3.38	2.28	5.77	3.70	2.32	5.95	3.98	2.32	6.32	3.97	2.36	6.67	4.23	2.38	

AFR : Air flow rate (m<sup>3</sup>/min)  
 TC : Total capacity (kW)  
 SHC : Sensible Heat capacity (kW)  
 IP : Input Power (kW)

# MODEL: ASU30RLXB

AFR	659
-----	-----

		Indoor temperature																		
		64°FDB			70°FDB			75°FDB			80°FDB			85°FDB			90°FDB			
		54°FWB			60°FWB			63°FWB			67°FWB			71°FWB			73°FWB			
Outdoor temperature	°FDB	TC	SHC	IP	TC	SHC	IP	TC	SHC	IP	TC	SHC	IP	TC	SHC	IP	TC	SHC	IP	
	14	25.7	18.3	0.80	28.6	18.4	0.81	31.5	20.1	0.82	32.5	21.7	0.83	34.5	21.6	0.84	36.4	23.0	0.84	
	23	25.7	18.7	0.93	28.6	18.8	0.94	31.5	20.5	0.95	32.5	22.1	0.96	34.5	22.0	0.97	36.4	23.5	0.98	
	32	25.7	19.0	1.05	28.6	19.2	1.07	31.5	20.9	1.08	32.5	22.6	1.09	34.4	22.5	1.10	36.4	23.9	1.11	
	41	25.7	18.3	1.17	28.6	18.4	1.19	31.5	20.1	1.21	32.5	21.7	1.22	34.4	21.6	1.23	36.4	23.0	1.24	
	50	25.6	18.7	1.33	28.5	18.8	1.35	31.4	20.5	1.37	32.4	22.1	1.37	34.3	22.0	1.39	36.3	23.5	1.40	
	59	25.1	18.2	1.47	28.0	18.4	1.49	30.8	20.0	1.51	31.8	21.6	1.52	33.7	21.5	1.53	35.6	22.9	1.55	
	67	24.4	18.0	1.71	27.2	18.2	1.74	30.0	19.8	1.76	30.9	21.4	1.77	32.8	21.3	1.79	34.7	22.7	1.81	
	77	26.3	19.1	2.45	29.3	19.2	2.49	32.4	20.9	2.53	33.4	22.6	2.54	35.4	22.5	2.57	37.4	24.0	2.59	
	87	25.1	18.4	2.74	27.9	18.5	2.79	30.8	20.2	2.83	31.7	21.8	2.84	33.6	21.7	2.87	35.5	23.1	2.90	
	95	23.7	17.6	3.05	26.4	17.7	3.10	29.1	19.4	3.14	30.0	20.9	3.16	31.8	20.8	3.19	33.6	22.2	3.22	
	104	22.1	16.8	3.35	24.7	16.9	3.40	27.2	18.4	3.45	28.0	19.9	3.47	29.7	19.8	3.50	31.4	21.1	3.54	
115	16.9	14.0	2.80	18.8	14.1	2.84	20.7	15.4	2.88	21.3	16.6	2.90	22.6	16.6	2.93	23.9	17.7	2.96		

AFR : Air flow rate (CFM)  
 TC : Total capacity (kBtu/h)  
 SHC : Sensible Heat capacity (kBtu/h)  
 IP : Input Power (kW)

AFR	18.7
-----	------

		Indoor temperature																		
		17.8°CDB			21.1°CDB			23.9°CDB			26.7°CDB			29.4°CDB			32.2°CDB			
		12.2°CWB			15.6°CWB			17.7°CWB			19.4°CWB			21.7°CWB			22.8°CWB			
Outdoor temperature	°CDB	TC	SHC	IP	TC	SHC	IP	TC	SHC	IP	TC	SHC	IP	TC	SHC	IP	TC	SHC	IP	
	-10.0	7.53	5.37	0.80	8.39	5.40	0.81	9.25	5.89	0.82	9.53	6.36	0.83	10.10	6.34	0.84	10.68	6.75	0.84	
	-5.0	7.53	5.48	0.93	8.38	5.51	0.94	9.24	6.01	0.95	9.53	6.49	0.96	10.10	6.46	0.97	10.67	6.88	0.98	
	0.0	7.52	5.58	1.05	8.38	5.61	1.07	9.24	6.12	1.08	9.52	6.61	1.09	10.09	6.59	1.10	10.66	7.02	1.11	
	5.0	7.52	5.36	1.17	8.37	5.40	1.19	9.23	5.88	1.21	9.52	6.35	1.22	10.09	6.33	1.23	10.66	6.74	1.24	
	10.0	7.50	5.47	1.33	8.35	5.51	1.35	9.21	6.01	1.37	9.49	6.49	1.37	10.06	6.46	1.39	10.63	6.88	1.40	
	15.0	7.36	5.35	1.47	8.20	5.38	1.49	9.03	5.87	1.51	9.31	6.34	1.52	9.87	6.31	1.53	10.43	6.72	1.55	
	19.4	7.16	5.29	1.71	7.98	5.32	1.74	8.80	5.80	1.76	9.07	6.27	1.77	9.61	6.24	1.79	10.16	6.65	1.81	
	25.0	7.72	5.60	2.45	8.60	5.63	2.49	9.48	6.14	2.53	9.77	6.63	2.54	10.36	6.60	2.57	10.95	7.03	2.59	
	30.6	7.35	5.39	2.74	8.19	5.42	2.79	9.02	5.91	2.83	9.30	6.39	2.84	9.86	6.36	2.87	10.42	6.78	2.90	
	35.0	6.94	5.17	3.05	7.74	5.20	3.10	8.53	5.67	3.14	8.79	6.12	3.16	9.32	6.10	3.19	9.84	6.50	3.22	
	40.0	6.49	4.93	3.35	7.23	4.95	3.40	7.97	5.40	3.45	8.22	5.84	3.47	8.71	5.81	3.50	9.20	6.19	3.54	
46.1	4.94	4.12	2.80	5.51	4.14	2.84	6.07	4.52	2.88	6.26	4.88	2.90	6.63	4.86	2.93	7.01	5.17	2.96		

AFR : Air flow rate (m<sup>3</sup>/min)  
 TC : Total capacity (kW)  
 SHC : Sensible Heat capacity (kW)  
 IP : Input Power (kW)

**MODEL: ASU36RLXB**

AFR	659
-----	-----

		Indoor temperature																		
		64°FDB			70°FDB			75°FDB			80°FDB			85°FDB			90°FDB			
		54°FWB			60°FWB			63°FWB			67°FWB			71°FWB			73°FWB			
Outdoor temperature	°FDB	TC	SHC	IP	TC	SHC	IP	TC	SHC	IP	TC	SHC	IP	TC	SHC	IP	TC	SHC	IP	
	14	27.6	19.9	1.01	30.8	20.0	1.03	33.9	21.9	1.04	35.0	23.6	1.05	37.1	23.5	1.06	39.2	25.1	1.07	
	23	27.6	20.3	1.17	30.8	20.4	1.19	33.9	22.3	1.21	34.9	24.1	1.21	37.0	24.0	1.22	39.1	25.5	1.24	
	32	27.6	20.7	1.33	30.7	20.8	1.35	33.9	22.7	1.37	34.9	24.5	1.38	37.0	24.4	1.39	39.1	26.0	1.41	
	41	27.6	19.9	1.48	30.7	20.0	1.51	33.9	21.8	1.53	34.9	23.6	1.54	37.0	23.5	1.55	39.1	25.0	1.57	
	50	27.5	20.3	1.68	30.6	20.4	1.70	33.8	22.3	1.73	34.8	24.0	1.74	36.9	23.9	1.76	39.0	25.5	1.77	
	59	27.3	20.2	1.85	30.4	20.3	1.88	33.6	22.1	1.91	34.6	23.9	1.92	36.7	23.8	1.94	38.7	25.4	1.96	
	67	26.3	19.6	2.16	29.3	19.7	2.20	32.3	21.5	2.23	33.3	23.2	2.24	35.3	23.1	2.27	37.3	24.6	2.29	
	77	28.3	20.8	3.10	31.6	20.9	3.15	34.8	22.8	3.20	35.9	24.6	3.21	38.0	24.5	3.25	40.2	26.1	3.28	
	87	27.0	20.0	3.47	30.0	20.1	3.52	33.1	21.9	3.58	34.1	23.7	3.60	36.2	23.6	3.63	38.2	25.1	3.67	
	95	25.5	19.2	3.86	28.4	19.3	3.92	31.3	21.0	3.98	33.0	21.8	3.88	34.2	22.6	4.04	36.1	24.1	4.08	
	104	23.8	18.2	4.23	26.5	18.3	4.30	29.2	20.0	4.37	30.1	21.6	4.39	31.9	21.5	4.43	33.8	22.9	4.48	
115	18.1	15.2	3.54	20.2	15.3	3.59	22.3	16.7	3.65	22.9	18.0	3.67	24.3	17.9	3.70	25.7	19.1	3.74		

AFR : Air flow rate (CFM)  
TC : Total capacity (kBtu/h)  
SHC : Sensible Heat capacity (kBtu/h)  
IP : Input Power (kW)

AFR	19.7
-----	------

		Indoor temperature																		
		17.8°CDB			21.1°CDB			23.9°CDB			26.7°CDB			29.4°CDB			32.2°CDB			
		12.2°CWB			15.6°CWB			17.7°CWB			19.4°CWB			21.7°CWB			22.8°CWB			
Outdoor temperature	°CDB	TC	SHC	IP	TC	SHC	IP	TC	SHC	IP	TC	SHC	IP	TC	SHC	IP	TC	SHC	IP	
	-10.0	8.10	5.84	1.01	9.02	5.88	1.03	9.94	6.41	1.04	10.25	6.92	1.05	10.86	6.89	1.06	11.48	7.34	1.07	
	-5.0	8.09	5.95	1.17	9.01	5.99	1.19	9.94	6.53	1.21	10.24	7.05	1.21	10.86	7.02	1.22	11.47	7.48	1.24	
	0.0	8.09	6.06	1.33	9.01	6.10	1.35	9.93	6.65	1.37	10.24	7.18	1.38	10.85	7.15	1.39	11.47	7.62	1.41	
	5.0	8.08	5.83	1.48	9.00	5.87	1.51	9.92	6.40	1.53	10.23	6.91	1.54	10.84	6.88	1.55	11.46	7.33	1.57	
	10.0	8.06	5.95	1.68	8.98	5.98	1.70	9.90	6.53	1.73	10.21	7.05	1.74	10.82	7.02	1.76	11.43	7.48	1.77	
	15.0	8.01	5.92	1.85	8.92	5.95	1.88	9.83	6.49	1.91	10.14	7.01	1.92	10.75	6.98	1.94	11.35	7.44	1.96	
	19.4	7.70	5.75	2.16	8.58	5.78	2.20	9.46	6.30	2.23	9.75	6.81	2.24	10.33	6.78	2.27	10.92	7.22	2.29	
	25.0	8.30	6.08	3.10	9.25	6.12	3.15	10.19	6.67	3.20	10.51	7.21	3.21	11.14	7.18	3.25	11.77	7.65	3.28	
	30.6	7.90	5.86	3.47	8.80	5.89	3.52	9.70	6.43	3.58	10.00	6.94	3.60	10.60	6.91	3.63	11.20	7.36	3.67	
	35.0	7.47	5.61	3.86	8.32	5.65	3.92	9.17	6.16	3.98	9.70	6.39	3.88	10.02	6.62	4.04	10.58	7.06	4.08	
	40.0	6.98	5.35	4.23	7.77	5.38	4.30	8.57	5.87	4.37	8.83	6.33	4.39	9.36	6.31	4.43	9.89	6.72	4.48	
46.1	5.31	4.45	3.54	5.92	4.48	3.59	6.52	4.89	3.65	6.73	5.28	3.67	7.13	5.26	3.70	7.53	5.60	3.74		

AFR : Air flow rate (m³/min)  
TC : Total capacity (kW)  
SHC : Sensible Heat capacity (kW)  
IP : Input Power (kW)



## 6-2. HEATING CAPACITY

### MODEL: ASU18RLB

AFR	541
-----	-----

			Indoor temperature							
			60°FDB		65°FDB		70°FDB		75°FDB	
			°FDB	°FWB	TC	IP	TC	IP	TC	IP
Outdoor temperature	5	3	16.2	1.98	15.8	2.01	15.4	2.18	14.6	2.14
	14	12	17.3	1.87	16.9	1.90	16.5	2.13	15.6	2.02
	23	19	18.1	1.81	17.7	1.84	17.2	2.05	16.3	1.96
	32	28	18.2	1.81	17.8	1.85	17.3	1.95	16.5	1.96
	41	37	19.9	1.92	19.4	1.95	19.0	2.00	18.0	2.08
	47	43	21.0	1.98	20.5	2.01	20.0	2.06	19.0	2.14
	50	47	23.2	2.01	22.7	2.04	22.1	2.09	21.0	2.17
	59	50	24.0	2.05	23.4	2.09	22.9	2.10	21.8	2.22

AFR : Air flow rate (CFM)  
TC : Total capacity (kBtu/h)  
IP : Input Power (kW)

AFR	15.3
-----	------

			Indoor temperature							
			15.6°CDB		18.3°CDB		21.1°CDB		23.9°CDB	
			°CDB	°CWB	TC	IP	TC	IP	TC	IP
Outdoor temperature	-15.0	-16.1	4.73	1.98	4.64	2.01	4.51	2.18	4.29	2.14
	-10.0	-11.1	5.08	1.87	4.95	1.90	4.83	2.13	4.59	2.02
	-5.0	-7.2	5.30	1.81	5.17	1.84	5.03	2.05	4.78	1.96
	0.0	-2.2	5.35	1.81	5.22	1.85	5.08	1.95	4.83	1.96
	5.0	2.8	5.84	1.92	5.69	1.95	5.57	2.00	5.27	2.08
	8.3	6.1	6.16	1.98	6.01	2.01	5.86	2.06	5.57	2.14
	10.0	8.3	6.79	2.01	6.65	2.04	6.47	2.09	6.16	2.17
	15.0	10.0	7.04	2.05	6.87	2.09	6.72	2.10	6.38	2.22

AFR : Air flow rate (m<sup>3</sup>/min)  
TC : Total capacity (kW)  
IP : Input Power (kW)

### MODEL: ASU24RLB

AFR	647
-----	-----

			Indoor temperature							
			60°FDB		65°FDB		70°FDB		75°FDB	
			°FDB	°FWB	TC	IP	TC	IP	TC	IP
Outdoor temperature	5	3	21.8	2.44	21.4	2.48	20.8	2.69	19.8	2.64
	14	12	23.4	2.30	22.8	2.34	22.3	2.62	21.1	2.49
	23	19	24.4	2.23	23.8	2.27	23.2	2.53	22.0	2.41
	32	28	24.6	2.23	24.1	2.28	23.4	2.40	22.3	2.42
	41	37	26.9	2.37	26.2	2.41	25.6	2.46	24.3	2.56
	47	43	28.4	2.44	27.7	2.48	27.0	2.54	25.6	2.64
	50	47	31.3	2.48	30.6	2.52	29.8	2.58	28.4	2.68
	59	50	32.4	2.53	31.6	2.57	31.0	2.59	29.4	2.73

AFR : Air flow rate (CFM)  
TC : Total capacity (kBtu/h)  
IP : Input Power (kW)

AFR	18.3
-----	------

			Indoor temperature							
			15.6°CDB		18.3°CDB		21.1°CDB		23.9°CDB	
			°CDB	°CWB	TC	IP	TC	IP	TC	IP
Outdoor temperature	-15.0	-16.1	6.39	2.44	6.26	2.48	6.09	2.69	5.79	2.64
	-10.0	-11.1	6.85	2.30	6.69	2.34	6.52	2.62	6.19	2.49
	-5.0	-7.2	7.15	2.23	6.99	2.27	6.79	2.53	6.46	2.41
	0.0	-2.2	7.22	2.23	7.05	2.28	6.85	2.40	6.52	2.42
	5.0	2.8	7.88	2.37	7.68	2.41	7.52	2.46	7.12	2.56
	8.3	6.1	8.31	2.44	8.11	2.48	7.91	2.54	7.52	2.64
	10.0	8.3	9.17	2.48	8.97	2.52	8.74	2.58	8.31	2.68
	15.0	10.0	9.50	2.53	9.27	2.57	9.07	2.59	8.61	2.73

AFR : Air flow rate (m<sup>3</sup>/min)  
TC : Total capacity (kW)  
IP : Input Power (kW)

## MODEL: ASU30RLXB

AFR	677
-----	-----

Outdoor temperature		Indoor temperature									
				60°FDB		65°FDB		70°FDB		75°FDB	
		°FDB	°FWB	TC	IP	TC	IP	TC	IP	TC	IP
5	3	23.2	3.78	22.7	3.86	22.1	3.94	21.0	4.10		
14	12	25.0	3.78	24.4	3.86	23.8	3.93	22.6	4.09		
23	19	28.8	3.79	28.1	3.87	27.5	3.95	26.1	4.11		
32	28	31.6	3.76	30.9	3.84	30.1	3.91	28.6	4.07		
41	37	34.6	3.80	33.8	3.88	32.9	3.96	31.3	4.12		
47	43	34.7	3.15	33.8	3.21	33.0	3.28	31.4	3.41		
50	47	35.7	3.14	34.8	3.20	34.0	3.27	32.3	3.40		
59	50	34.4	2.74	33.6	2.80	32.8	2.86	31.1	2.97		

AFR : Air flow rate (CFM)  
TC : Total capacity (kBtu/h)  
IP : Input Power (kW)

AFR	19.2
-----	------

Outdoor temperature		Indoor temperature									
				15.6°CDB		18.3°CDB		21.1°CDB		23.9°CDB	
		°CDB	°CWB	TC	IP	TC	IP	TC	IP	TC	IP
-15.0	-16.1	6.81	3.78	6.65	3.86	6.48	3.94	6.16	4.10		
-10.0	-11.1	7.33	3.78	7.15	3.86	6.98	3.93	6.63	4.09		
-5.0	-7.2	8.45	3.79	8.25	3.87	8.05	3.95	7.65	4.11		
0.0	-2.2	9.27	3.76	9.05	3.84	8.83	3.91	8.38	4.07		
5.0	2.8	10.14	3.80	9.90	3.88	9.66	3.96	9.17	4.12		
8.3	6.1	10.16	3.15	9.91	3.21	9.70	3.28	9.19	3.41		
10.0	8.3	10.46	3.14	10.21	3.20	9.96	3.27	9.47	3.40		
15.0	10.0	10.09	2.74	9.85	2.80	9.61	2.86	9.13	2.97		

AFR : Air flow rate (m<sup>3</sup>/min)  
TC : Total capacity (kW)  
IP : Input Power (kW)

## MODEL: ASU36RLXB

AFR	695
-----	-----

Outdoor temperature		Indoor temperature									
				60°FDB		65°FDB		70°FDB		75°FDB	
		°FDB	°FWB	TC	IP	TC	IP	TC	IP	TC	IP
5	3	24.6	4.04	24.1	4.12	23.5	4.20	22.3	4.28		
14	12	26.5	4.03	25.9	4.11	25.3	4.20	24.0	4.28		
23	19	30.6	4.05	29.9	4.13	29.1	4.22	27.7	4.28		
32	28	33.5	4.01	32.7	4.09	31.9	4.18	30.3	4.28		
41	37	36.7	4.06	35.8	4.14	34.9	4.23	33.2	4.28		
47	43	36.8	3.36	35.9	3.43	35.0	3.50	33.3	3.64		
50	47	37.9	3.35	37.0	3.42	36.1	3.49	34.3	3.63		
59	50	36.5	2.92	35.6	2.99	34.8	3.05	33.0	3.17		

AFR : Air flow rate (CFM)  
TC : Total capacity (kBtu/h)  
IP : Input Power (kW)

AFR	19.7
-----	------

Outdoor temperature		Indoor temperature									
				15.6°CDB		18.3°CDB		21.1°CDB		23.9°CDB	
		°CDB	°CWB	TC	IP	TC	IP	TC	IP	TC	IP
-15.0	-16.1	7.22	4.04	7.05	4.12	6.88	4.20	6.53	4.28		
-10.0	-11.1	7.77	4.03	7.59	4.11	7.40	4.20	7.03	4.28		
-5.0	-7.2	8.96	4.05	8.75	4.13	8.54	4.22	8.11	4.28		
0.0	-2.2	9.83	4.01	9.59	4.09	9.36	4.18	8.89	4.28		
5.0	2.8	10.75	4.06	10.50	4.14	10.24	4.23	9.73	4.28		
8.3	6.1	10.77	3.36	10.51	3.43	10.26	3.50	9.75	3.64		
10.0	8.3	11.10	3.35	10.83	3.42	10.57	3.49	10.04	3.63		
15.0	10.0	10.70	2.92	10.45	2.99	10.19	3.05	9.68	3.17		

AFR : Air flow rate (m<sup>3</sup>/min)  
TC : Total capacity (kW)  
IP : Input Power (kW)

# 7. FAN PERFORMANCE

## 7-1. AIR VELOCITY DISTRIBUTION

### MODEL: ASU18RLB

Conditions:  
 Fan speed : High  
 Operation mode : FAN  
 Voltage : 230V

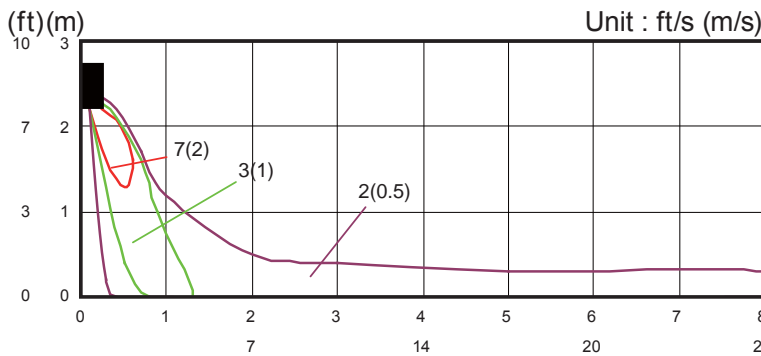
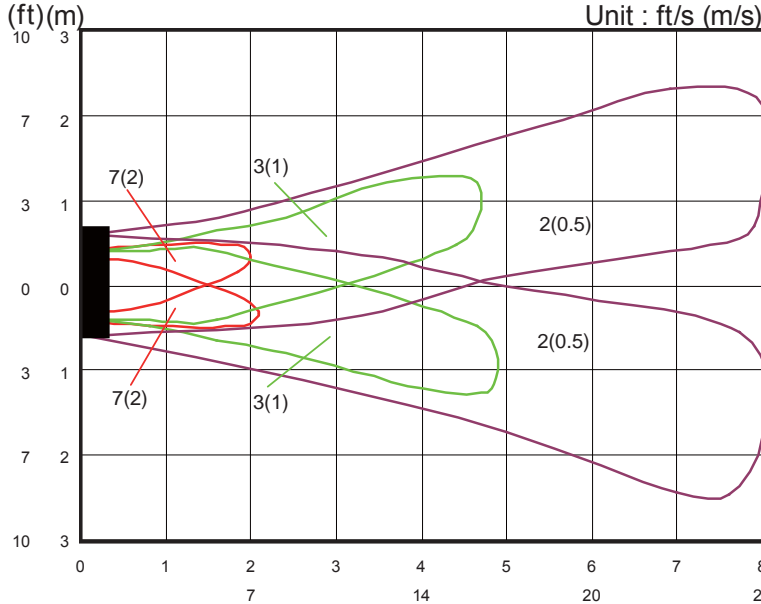
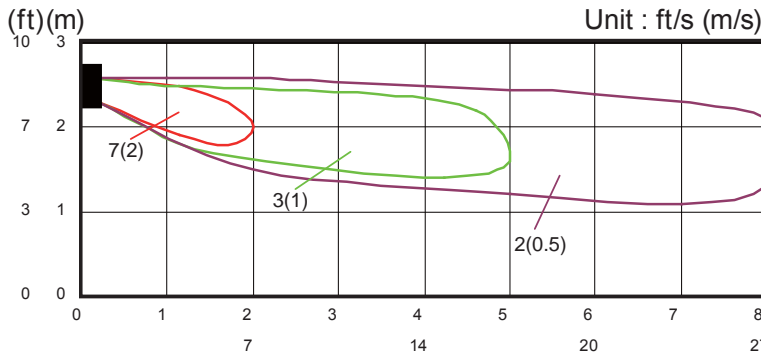
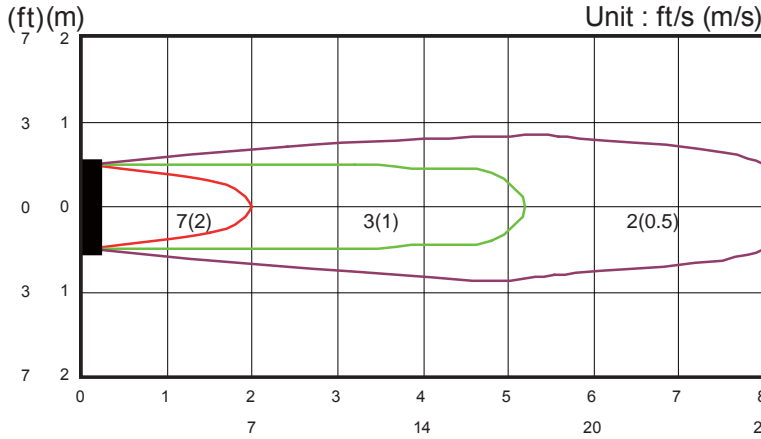

**MODEL: ASU24RLB**

Conditions:  
Fan speed : High  
Operation mode : FAN  
Voltage : 230V

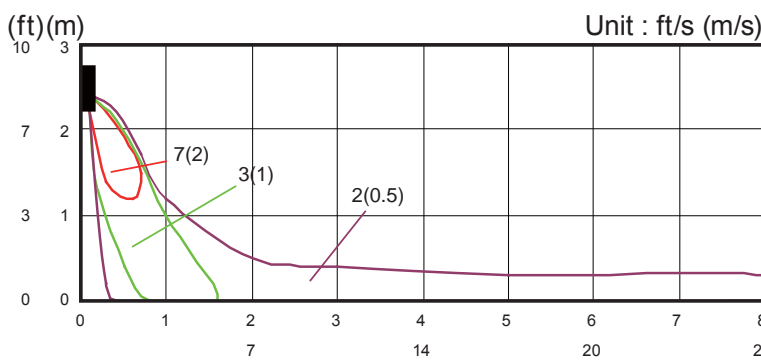
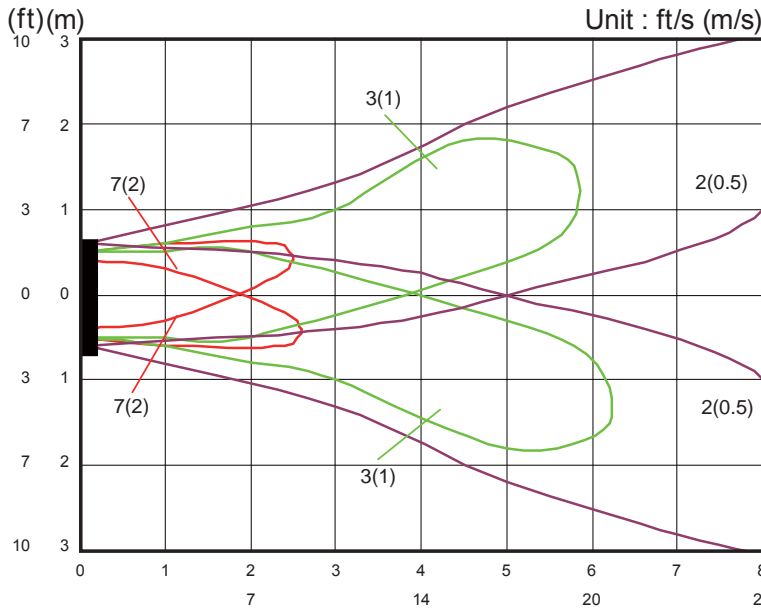
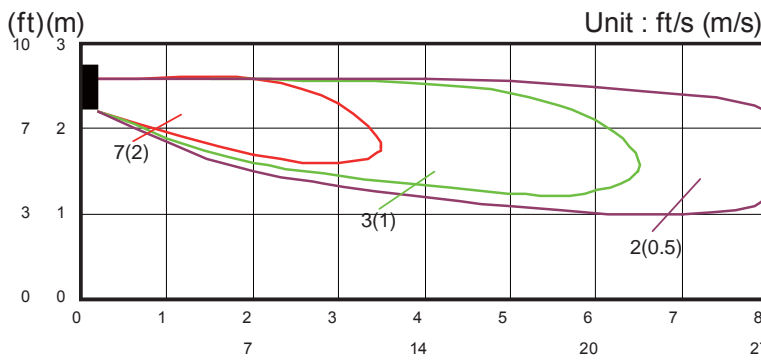
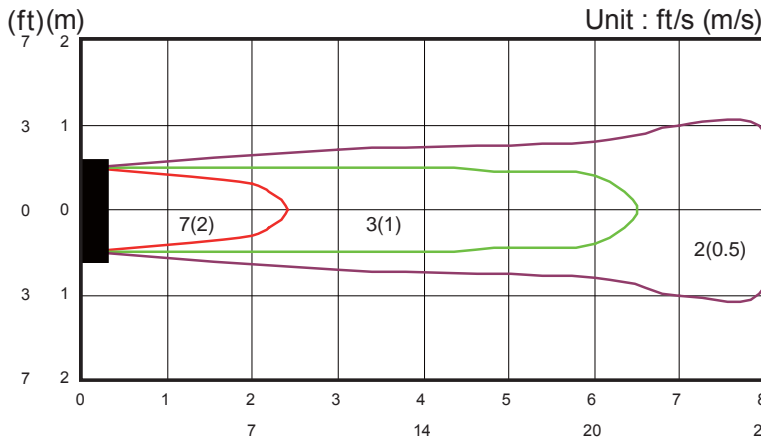

Conditions:  
Fan speed : High  
Operation mode : FAN  
Voltage : 230V

**MODEL: ASU30RLXB**

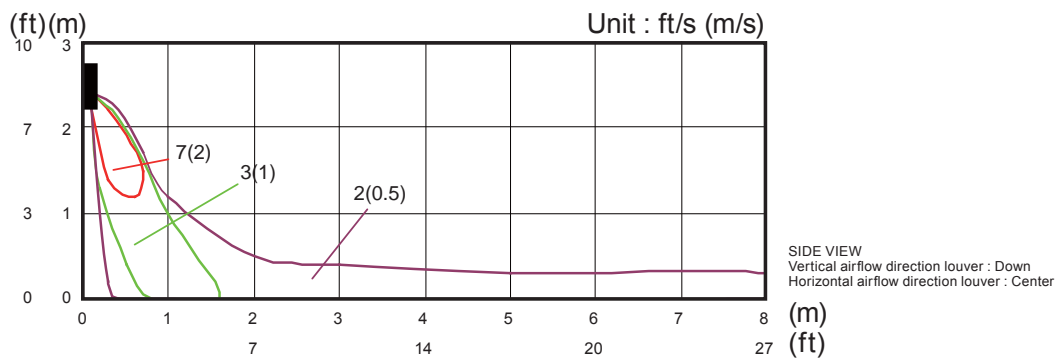
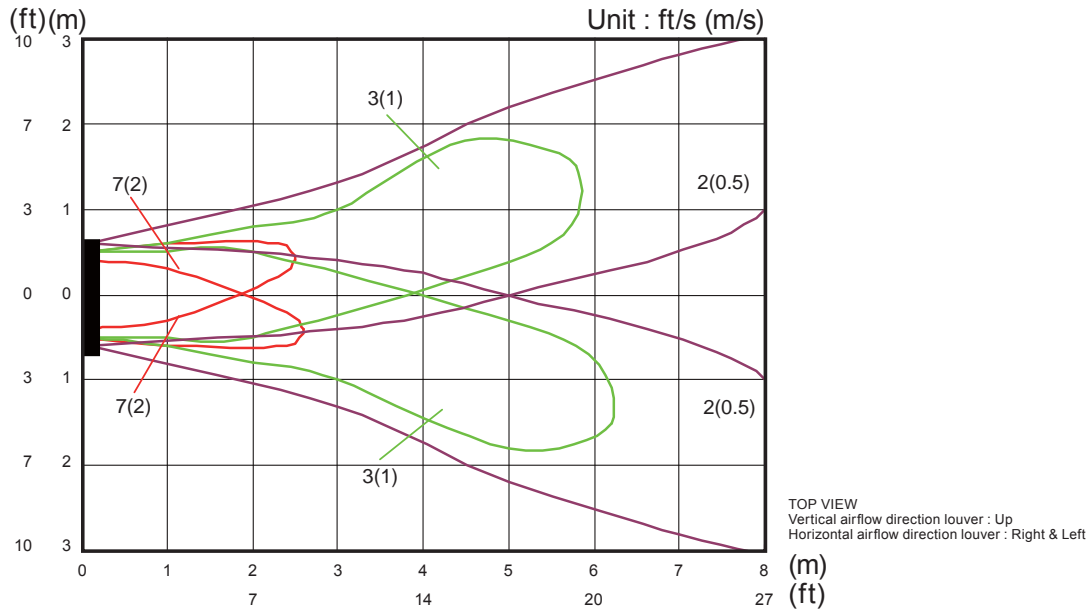
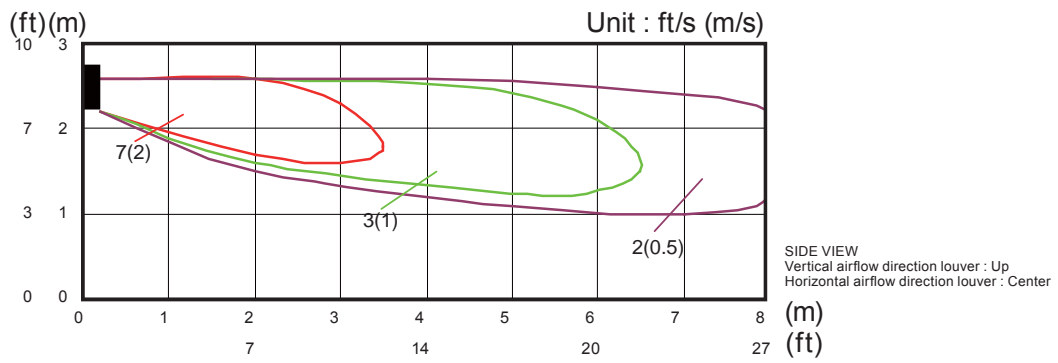
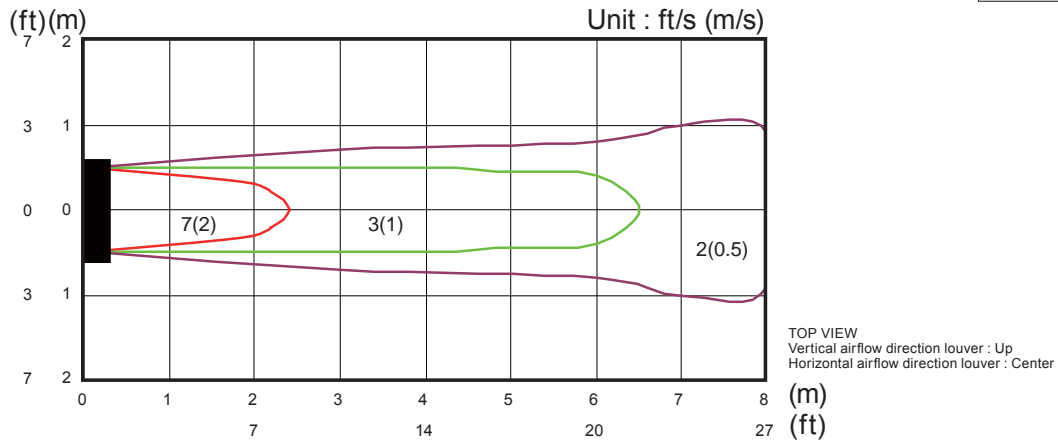

**MODEL: ASU36RLXB**

Conditions:  
Fan speed : High  
Operation mode : FAN  
Voltage : 230V

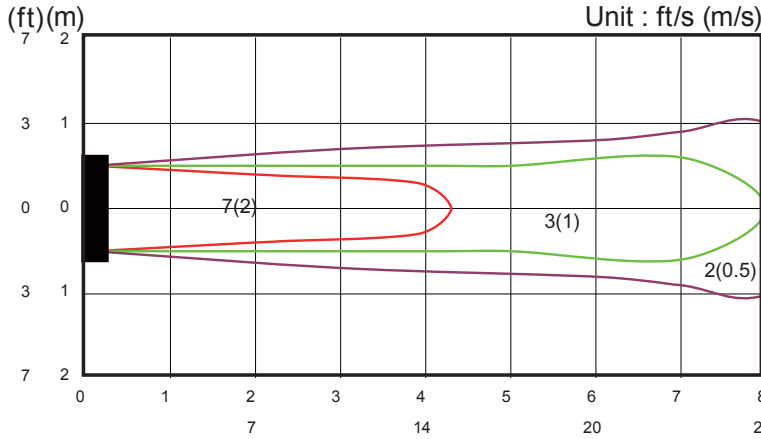

TOP VIEW  
Vertical airflow direction louver : Up  
Horizontal airflow direction louver : Center

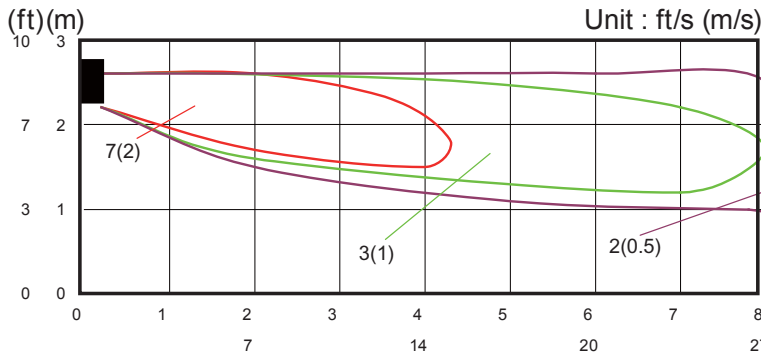

SIDE VIEW  
Vertical airflow direction louver : Up  
Horizontal airflow direction louver : Center

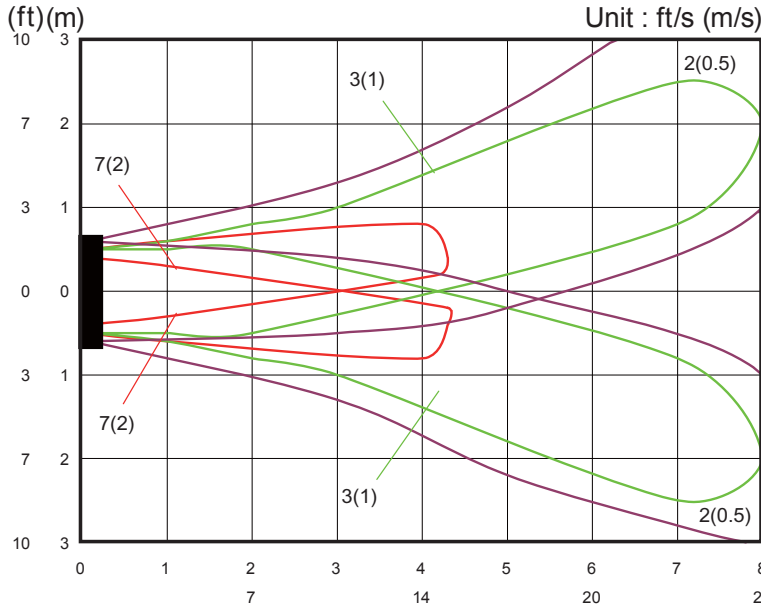

TOP VIEW  
Vertical airflow direction louver : Up  
Horizontal airflow direction louver : Right & Left

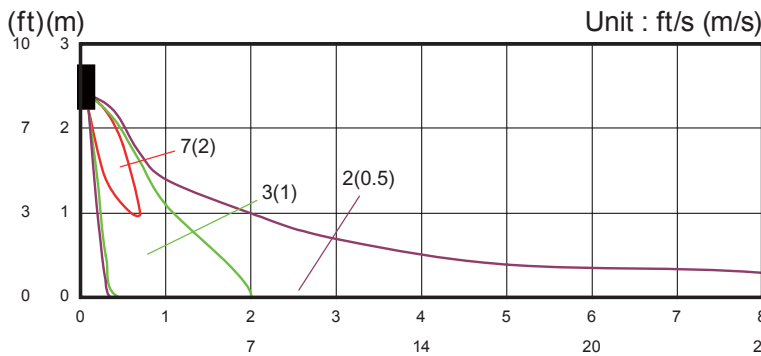

SIDE VIEW  
Vertical airflow direction louver : Down  
Horizontal airflow direction louver : Center

## 7-2. AIR FLOW

### ■ MODEL: ASU18RLB

#### ● Cooling

Fan speed	Air flow	
HIGH	920	m <sup>3</sup> /h
	256	l/s
	541	CFM
MED	740	m <sup>3</sup> /h
	206	l/s
	435	CFM
LOW	620	m <sup>3</sup> /h
	172	l/s
	365	CFM
QUIET	520	m <sup>3</sup> /h
	144	l/s
	306	CFM

#### ● Heating

Fan speed	Air flow	
HIGH	920	m <sup>3</sup> /h
	256	l/s
	541	CFM
MED	740	m <sup>3</sup> /h
	206	l/s
	435	CFM
LOW	620	m <sup>3</sup> /h
	172	l/s
	365	CFM
QUIET	540	m <sup>3</sup> /h
	150	l/s
	318	CFM

■ **MODEL: ASU24RLB**

● **Cooling**

Fan speed	Air flow	
HIGH	1120	m <sup>3</sup> /h
	311	l/s
	659	CFM
MED	900	m <sup>3</sup> /h
	250	l/s
	530	CFM
LOW	740	m <sup>3</sup> /h
	206	l/s
	435	CFM
QUIET	620	m <sup>3</sup> /h
	172	l/s
	365	CFM

● **Heating**

Fan speed	Air flow	
HIGH	1100	m <sup>3</sup> /h
	306	l/s
	647	CFM
MED	900	m <sup>3</sup> /h
	250	l/s
	530	CFM
LOW	740	m <sup>3</sup> /h
	206	l/s
	435	CFM
QUIET	620	m <sup>3</sup> /h
	172	l/s
	365	CFM



■ **MODEL: ASU30RLXB**

● **Cooling**

Fan speed	Air flow	
HIGH	1120	m <sup>3</sup> /h
	311	l/s
	659	CFM
MED	900	m <sup>3</sup> /h
	250	l/s
	530	CFM
LOW	740	m <sup>3</sup> /h
	206	l/s
	435	CFM
QUIET	620	m <sup>3</sup> /h
	172	l/s
	365	CFM

● **Heating**

Fan speed	Air flow	
HIGH	1150	m <sup>3</sup> /h
	319	l/s
	677	CFM
MED	900	m <sup>3</sup> /h
	250	l/s
	530	CFM
LOW	740	m <sup>3</sup> /h
	206	l/s
	435	CFM
QUIET	620	m <sup>3</sup> /h
	172	l/s
	365	CFM

■ **MODEL: ASU36RLXB**

● **Cooling**

Fan speed	Air flow	
HIGH	1180	m <sup>3</sup> /h
	328	l/s
	694	CFM
MED	900	m <sup>3</sup> /h
	250	l/s
	530	CFM
LOW	740	m <sup>3</sup> /h
	206	l/s
	435	CFM
QUIET	620	m <sup>3</sup> /h
	172	l/s
	365	CFM

● **Heating**

Fan speed	Air flow	
HIGH	1180	m <sup>3</sup> /h
	328	l/s
	694	CFM
MED	900	m <sup>3</sup> /h
	250	l/s
	530	CFM
LOW	740	m <sup>3</sup> /h
	206	l/s
	435	CFM
QUIET	620	m <sup>3</sup> /h
	172	l/s
	365	CFM

# 8. OPERATION NOISE

## 8-1. NOISE LEVEL CURVE

### MODEL: ASU18RLB

#### ● Cooling

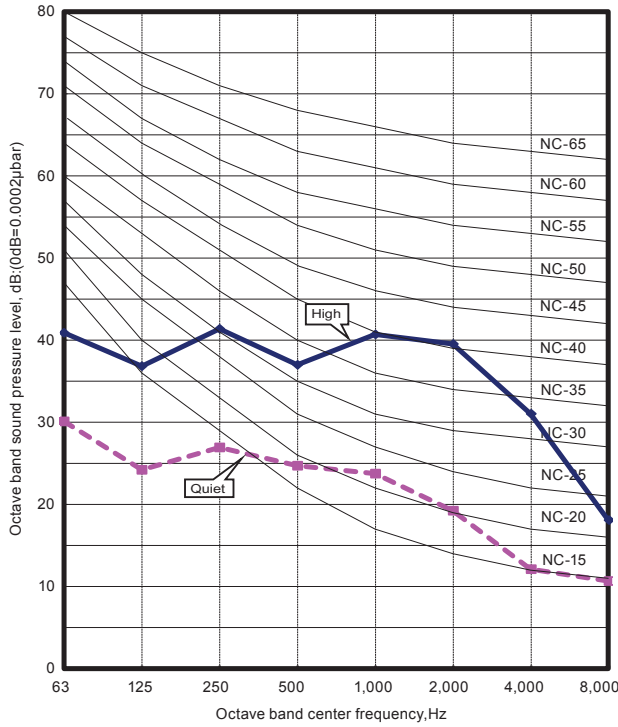

#### ● Heating

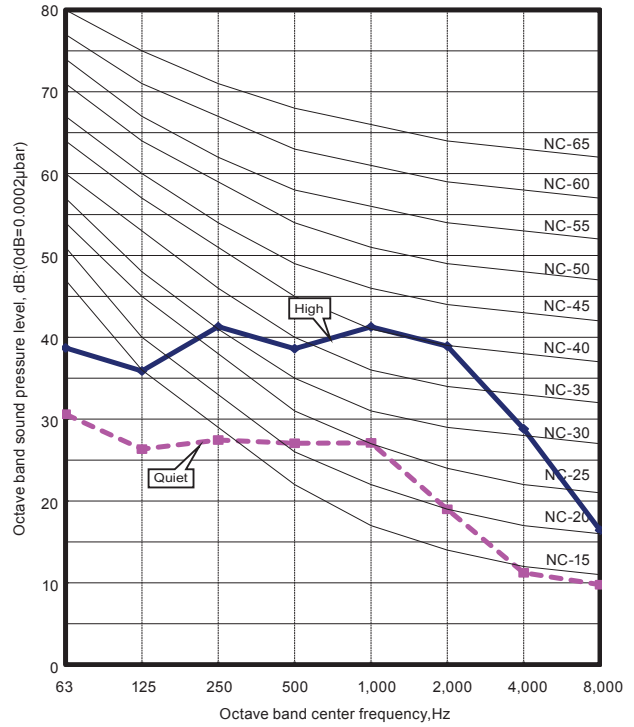

### MODEL: ASU24RLB

#### ● Cooling

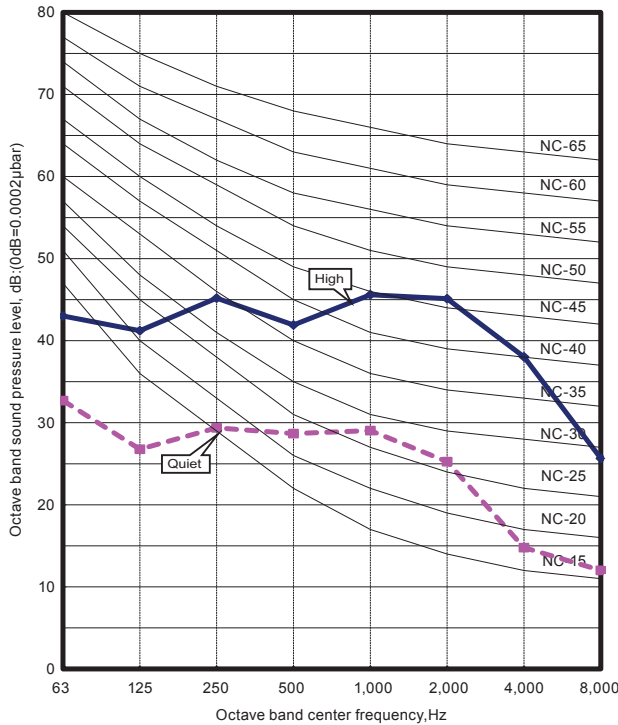

#### ● Heating

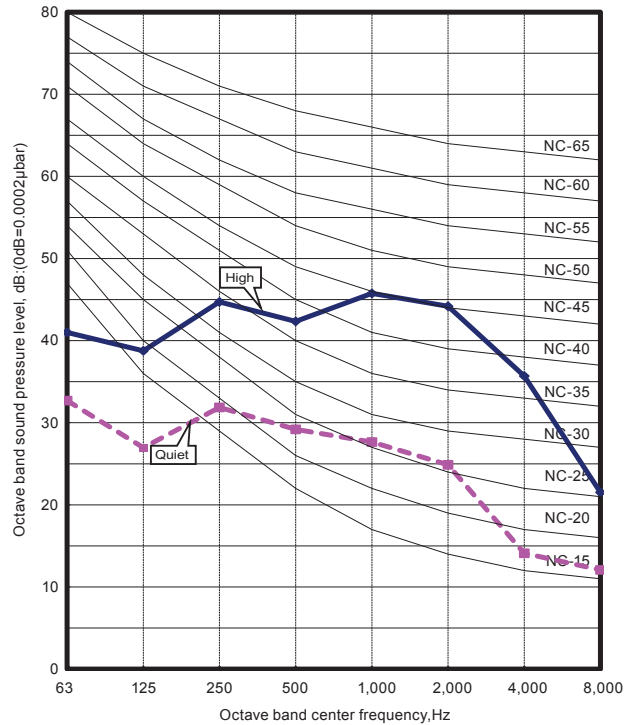

## MODEL: ASU30RLXB

### Cooling

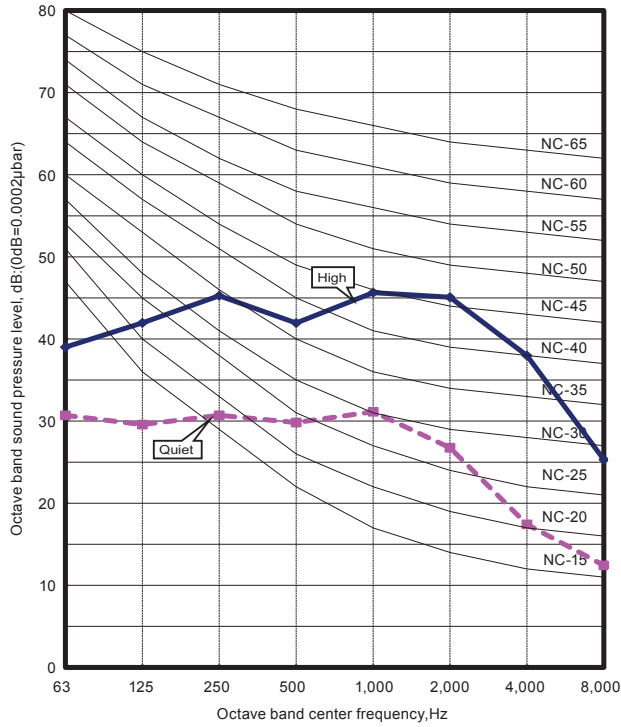

### Heating

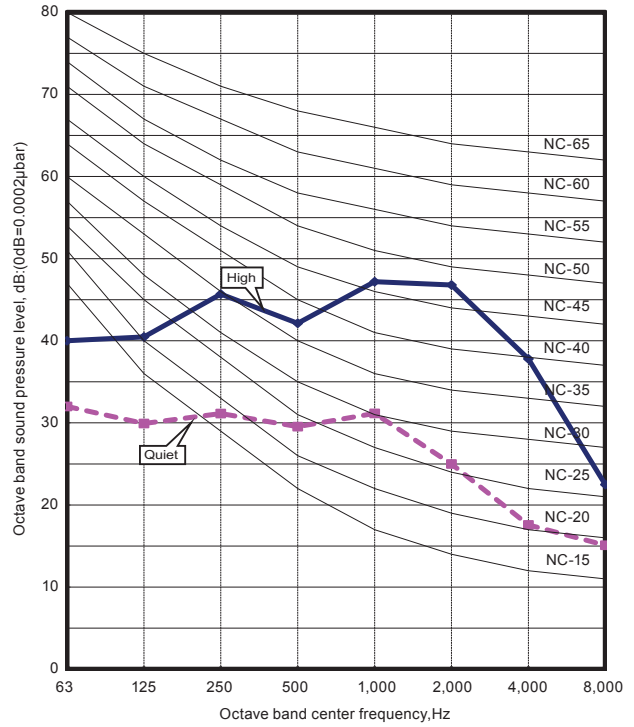

## MODEL: ASU36RLXB

### Cooling

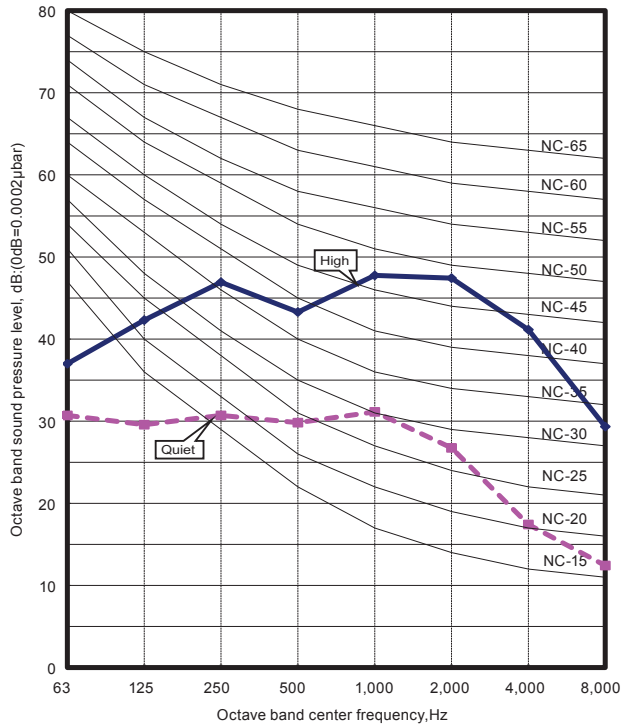

### Heating

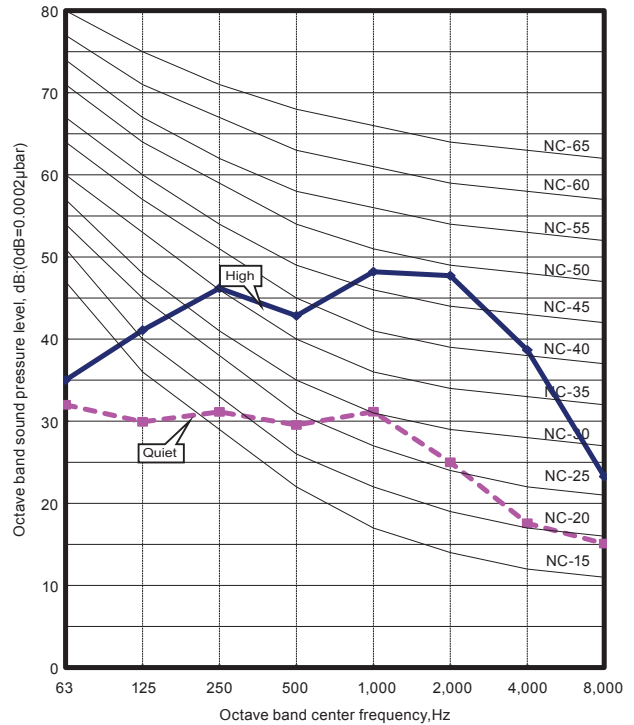

## 8-2. SOUND LEVEL CHECK POINT

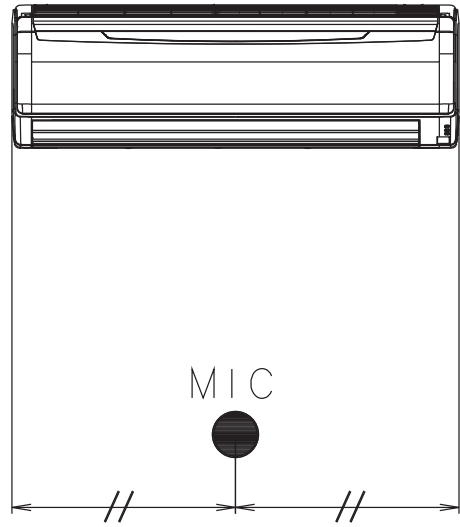
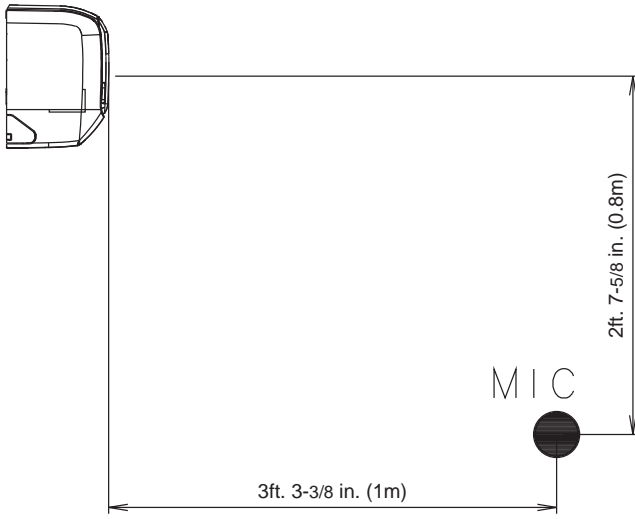

## 9. SAFETY DEVICES

	Protection form	Model			
		ASU18RLB	ASU24RLB	ASU30RLXB	ASU36RLXB
Circuit protection	Current fuse (PCB)	3.15A 250V			
Terminal protection	Current fuse	3A 250V			
Fan motor protection	Thermal protection program	302±27°F (150±15°C) OFF 248±27°F (120±15°C) ON			

# 10. EXTERNAL INPUT & OUTPUT

Connector	INPUT	OUTPUT	REMARKS
CN14	Control input	-	See external input/output settings for details.
CN16	-	Operation status output	

## 10-1. EXTERNAL INPUT

### ● CONTROL INPUT (Operation/Stop or Forced stop)

The air conditioner can be remotely operated by means of the following on-site work.  
 "Operation/Stop" mode or "Forced stop" mode can be selected with function setting of indoor unit.  
 Operation is started at the following contents by adding the contact input of a commercial ON/OFF switch to a connector on the external control PC board and turning it ON.

	Initial starting after power turned on	Starting other than at the left
Operation mode	Auto changeover	Mode at previous operation
Set temperature	76°F (24°C)	Temperature at previous operation
Air flow mode	AUTO	Mode at previous operation
Air direction (swing)	Standard air direction (swing OFF)	Air direction at previous operation

### ● Circuit diagram example

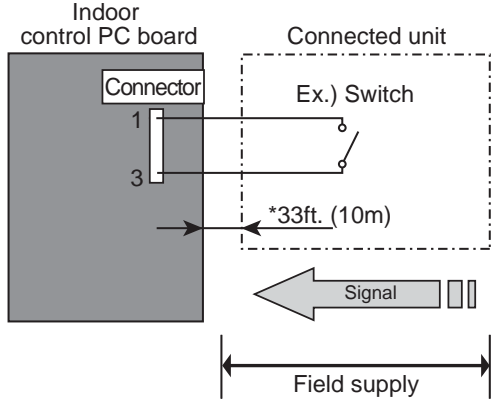

\* Make the distance from the PC board to the connected unit within 33ft. (10m).  
 Contact capacity : 24VDC or more, 10mA or more.  
 Please use the non-polar relays and switches.

### ● When function setting is "Operation/Stop" mode

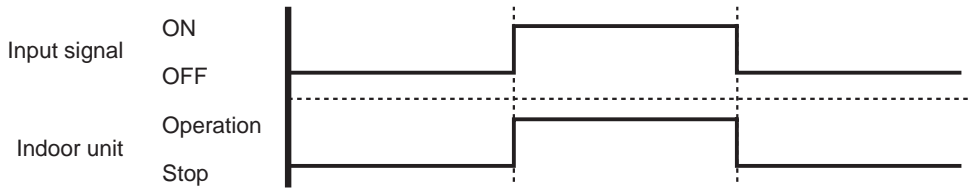

● When function setting is "Forced stop" mode

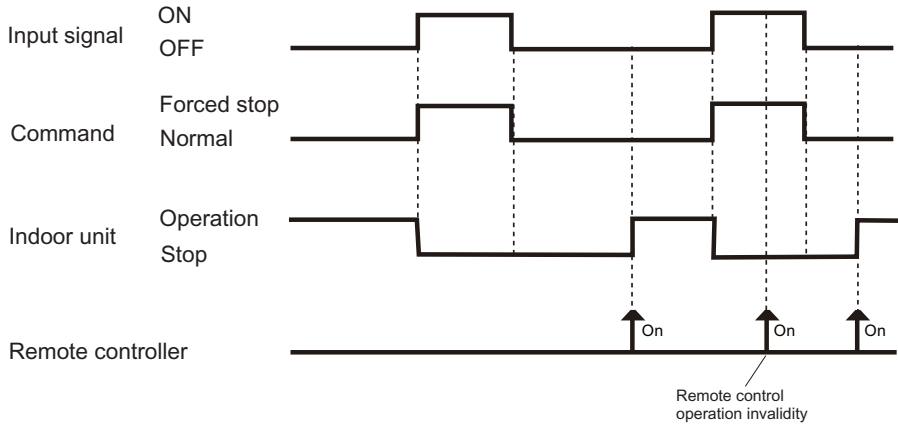

● Parts (Optional)

Parts name	Model name
External connect kit	UTY-XWZX

Wire (External input) : UTY-XWZX

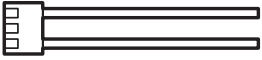



## 10-2. EXTERNAL OUTPUT

### ■ OPERATION STATUS OUTPUT

An air conditioner operation status signal can be output.

#### ● Circuit diagram example

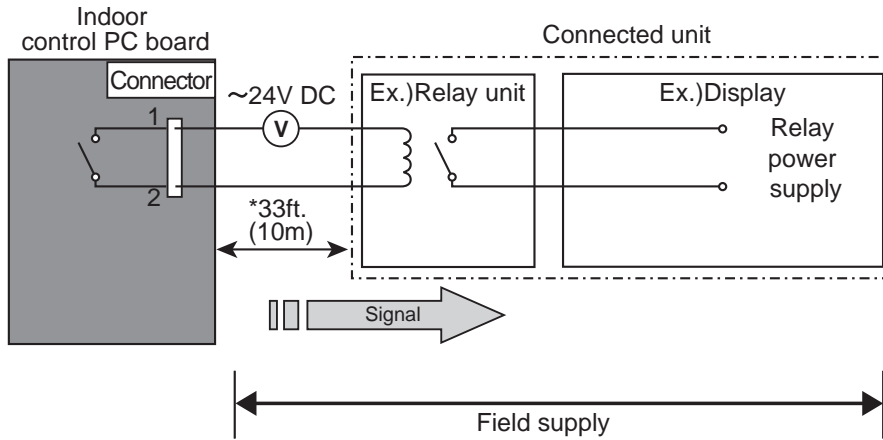

\* Make the distance from the PC board to the connected unit within 33ft. (10m).  
Relay spec. : Max.24VDC, 10mA to less than 500mA.

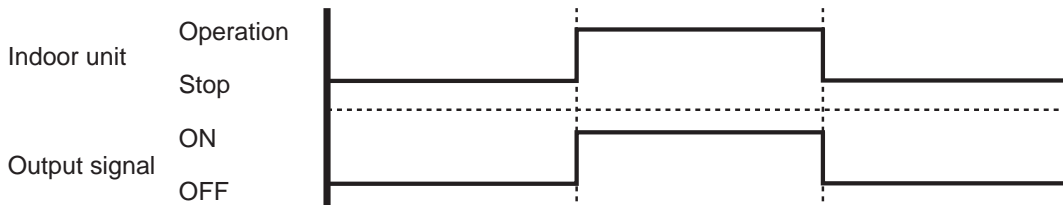

#### ● Parts (Optional)

Parts name	Model name
External connect kit	UTY-XWZX

Wire (External input) : UTY-XWZX

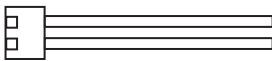

# 11. FUNCTION SETTING

## 11-1. INDOOR UNIT (Setting by remote controller)

- The function settings of the control of the indoor unit can be changed by this procedure according to the installation conditions. Incorrect settings can cause the indoor unit malfunction.
- After the power is turned on, perform the "FUNCTION SETTING" according to the installation conditions using the remote controller.
- The settings may be selected between the following two: Function Number or Setting Value.
- Settings will not be changed if invalid numbers or setting values are selected.

### ■ FUNCTION SETTING METHOD (for Wireless remote controller)

#### Entering the Function Setting Mode

- While pressing the FAN button and SET TEMP. (▲) simultaneously, press the RESET button to enter the function setting mode.

#### STEP 1

##### Setting the Remote controller Custom Code

Use the following steps to select the custom code of the remote controller. (Note that the air conditioner cannot receive a signal code if the air conditioner has not been set for the matching custom code.) The custom codes that are set through this process are applicable only to the signals in the FUNCTION SETTING. For details on how to set the custom codes through the normal process, refer to "REMOTE CONTROLLER CUSTOM CODE".

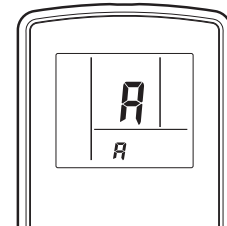

1. Press the SET TEMP. (▲) (▼) button to change the custom code between  $A \rightarrow b$  →  $c \rightarrow d$ . Match the code on the display to the air conditioner custom code. (initially set to  $A$ )  
(If the custom code does not need to be selected, press the MODE button and proceed to STEP 2.)
2. Press the TIMER MODE button and check that the indoor unit can receive signals at the displayed custom code.
3. Press the MODE button to accept the custom code, and proceed to STEP 2.

The air conditioner custom code is set to A prior to shipment.

The remote controller resets to custom code A when the batteries in the remote controller are replaced. If you use a custom code other than custom code A, reset the custom code after replacing the batteries. If you do not know the air conditioner custom code setting, try each of the custom codes ( $A \rightarrow b \rightarrow c \rightarrow d$ ) until you find the code which operates the air conditioner.

#### STEP 2

##### Selecting the Function Number and Setting Value

1. Press the SET TEMP. (▲) (▼) buttons to select the function number.  
(Press the MODE button to switch between the left and right digits.)
2. Press the FAN button to proceed to setting the value.  
Press the FAN button again to return to the function number selection.)
3. Press the SET TEMP. (▲) (▼) buttons to select the setting value.  
(Press the MODE button to switch between the left and right digits.)
4. Press the TIMER MODE button, and START/STOP button, in the order listed to confirm the settings.
5. Press the RESET button to cancel the function setting mode.
6. After completing the FUNCTION SETTING, be sure to turn off the power and turn it on again.

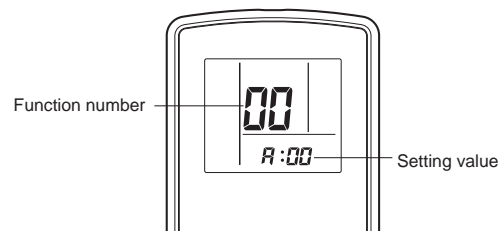

#### ⚠ CAUTION

After turning off the power, wait 30 seconds or more before turning it on again. The FUNCTION SETTING doesn't become effective if it doesn't do so.

## FUNCTION DETAILS

Functions	
1)	Filter sign
2)	Room temperature control for indoor unit sensor
3)	Auto restart
4)	Room temperature sensor switching
5)	Remote controller custom code
6)	External input control
7)	Room temperature sensor switching (Aux.)
8)	Room temperature control for wired remote controller sensor
9)	Fixed operation mode switching
10)	Heat Insulation condition (building insulation)

### 1) Filter sign

Select appropriate intervals for displaying the filter sign on the indoor unit according to the estimated amount of dust in the air of the room.

If the indication is not required, select "No indication" (03).

(◆... Factory setting)

Function number	Setting value	Setting description
11	00	Standard (400 hours)
	01	Long interval (1000 hours)
	02	Short interval (200 hours)
	03	No indication ◆

### 2) Room temperature control for indoor unit sensor

Refer to Function 95, before performing this setting.

Depending on the installed environment, correction of the room temperature sensor may be required. Select the appropriate control setting according to the installed environment.

The temperature correction values show the difference from the Standard setting "00" (manufacturer's recommended value).

\*When Function 95-01(High insulation) is set, the Standard setting "00" will be the same as No correction "01" [0.0°F (0.0°C)].

(◆... Factory setting)

Function number	Setting value	Setting description	
30 (For cooling)	31 (For heating)	00	Standard setting* ◆
		01	No correction 0.0°F (0.0°C)
		02	-1°F (-0.5°C)
		03	-2°F (-1.0°C)
		04	-3°F (-1.5°C)
		05	-4°F (-2.0°C)
		06	-5°F (-2.5°C)
		07	-6°F (-3.0°C)
		08	-7°F (-3.5°C)
		09	-8°F (-4.0°C)
		10	+1°F (+0.5°C)
		11	+2°F (+1.0°C)
		12	+3°F (+1.5°C)
		13	+4°F (+2.0°C)
		14	+5°F (+2.5°C)
		15	+6°F (+3.0°C)
		16	+7°F (+3.5°C)
17	+8°F (+4.0°C)		

More Cooling  
Less Heating

Less Cooling  
More Heating

### 3) Auto restart

Enable or disable automatic restart after a power interruption.

(◆... Factory setting)

Function number	Setting value	Setting description
40	00	Enable
	01	Disable

\*Auto restart is an emergency function such as for power outage etc.  
Do not attempt to use this function in normal operation.  
Be sure to operate the unit by remote controller or external device.

### 4) Room temperature sensor switching

(Only for Wired remote controller)

When using the Wired remote controller temperature sensor, change the setting to "Both" (01).

(◆... Factory setting)

Function number	Setting value	Setting description
42	00	Indoor unit
	01	Both

00: Sensor on the indoor unit is active.

01: Sensors on both indoor unit and wired remote controller are active.

\*Remote controller sensor must be turned on by using the remote controller.

### 5) Remote controller custom code

(Only for wireless remote controller)

The indoor unit custom code can be changed.

Select the appropriate custom code.

(◆... Factory setting)

Function number	Setting value	Setting description
44	00	A
	01	B
	02	C
	03	D

### 6) External input control

"Operation/Stop" mode or "Forced stop" mode can be selected.

(◆... Factory setting)

Function number	Setting value	Setting description
46	00	Operation/Stop mode
	01	(Setting prohibited)
	02	Forced stop mode

### 7) Room temperature sensor switching (Aux.)

To use the temperature sensor on the wired remote controller only, change the setting to "Wired remote controller" (01). This function will only work if the function setting 42 is set at "Both" (01)

(◆... Factory setting)

Function number	Setting value	Setting description
48	00	Both
	01	Wired remote controller

### 8) Room temperature control for wired remote controller sensor

Refer to Function 95, before performing this setting.

Depending on the installed environment, correction of the wired remote controller temperature sensor may be required. Select the appropriate control setting according to the installed environment.

To change this setting, set Function 42 to Both "01".

Ensure that the Thermo Sensor icon is displayed on the remote controller screen.

(◆... Factory setting)

Function number	Setting value	Setting description		
92 (For cooling)	93 (For heating)	00	No correction 0.0°F(0.0°C)	◆
		01	No correction 0.0°F (0.0°C)	
		02	-1°F (-0.5°C)	More Cooling Less Heating
		03	-2°F (-1.0°C)	
		04	-3°F (-1.5°C)	
		05	-4°F (-2.0°C)	
		06	-5°F (-2.5°C)	
		07	-6°F (-3.0°C)	
		08	-7°F (-3.5°C)	
		09	-8°F (-4.0°C)	Less Cooling More Heating
		10	+1°F (+0.5°C)	
		11	+2°F (+1.0°C)	
		12	+3°F (+1.5°C)	
		13	+4°F (+2.0°C)	
		14	+5°F (+2.5°C)	
		15	+6°F (+3.0°C)	
		16	+7°F (+3.5°C)	
17	+8°F (+4.0°C)			

### 9) Fixed operation mode switching

Sets the operation mode to heat pump, heating only, or cooling only.

(◆... Factory setting)

Function number	Setting value	Setting description	
94	00	Heat pump	◆
	01	Heating only	
	02	Cooling only	

### 10) Heat Insulation condition (building insulation)

Heat insulation conditions differ according to the installed environment.

Standard insulation "00" allows system to rapidly respond to the cooling or heating load changes. High insulation "01" is when the heat insulation structure of the building is high and does not require system to rapidly respond to cooling or heating load changes.

When High insulation "01" is selected;

- Overheating (overcooling) is prevented at the start-up.
- All room temp. control settings (Function 30, 31, 92, 93) will reset to No correction [0.0°F (0.0°C)].

(◆... Factory setting)

Function number	Setting value	Setting description	
95	00	Standard insulation	◆
	01	High insulation	

**NOTE:**

When changing Function 95, perform this setting before other Room temp. control settings (Function 30, 31, 92, 93). If Function 95 is not set first, Room temperature control settings (Function 30, 31, 92, 93) will be reset and you must re-do them again.

## ■ REMOTE CONTROLLER CUSTOM CODE SETTING

Use the following steps to select the custom code of the remote controller. (Note that the air conditioner cannot receive a signal if the air conditioner has not been set for the matching custom code.)

1. Press the START/STOP button until only the clock is displayed on the remote controller display.
2. Press the MODE button for at least five seconds to display the current custom code (initially set to  $\overline{A}$ ).
3. Press the SET TEMP. ( $\blacktriangle$ ) ( $\blacktriangledown$ ) button to change the custom code between  $\overline{A} \rightarrow \overline{B} \rightarrow \overline{C} \rightarrow \overline{D}$ .  
Match the code on the display to the air conditioner custom code.
4. Press the MODE button again to return to the clock display. The custom code will be changed.

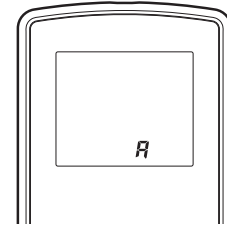



If no buttons are pressed within 30 seconds after the custom code is displayed, the system returns to the original clock display. In this case, start again from step 1.

The air conditioner custom code is set to A prior to shipment.  
Contact your retailer to change the custom code.

The remote controller resets to custom code A when the batteries in the remote controller are replaced. If you use a custom code other than custom code A, reset the custom code after replacing the batteries. If you do not know the air conditioner custom code setting, try each of the custom codes ( $\overline{A} \rightarrow \overline{B} \rightarrow \overline{C} \rightarrow \overline{D}$ ) until you find the code which operates the air conditioner.

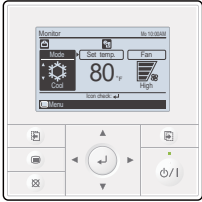
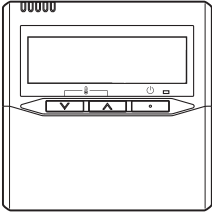
## 12. OPTIONAL PARTS

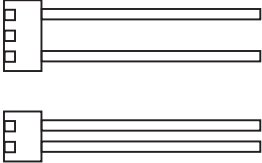
Exterior	Parts name	Model No.	Summary
	Wired remote controller	UTY-RVNUM	<p>Large and full-dot liquid crystal screen, wide and large keys easy to press, user-intuitive arrow key.</p> <p>*Optional communication kit is necessary for installation.</p>
	Wired remote controller	UTY-RNNUM	Unit control is performed by wired remote controller.
	Simple remote controller	UTY-RSNUM	<p>Compact remote controller concentrates on the basic functions such as Start/Stop, Fan Control, Temperature Setting and Operation mode.</p> <p>*Optional communication kit is necessary for installation.</p>
	External connect kit	UTY-XWZX	Use to connect with various peripheral devices and air conditioner PC board.

## **2. OUTDOOR UNIT**

---

**SINGLE TYPE :**

**AOU18RLB**

**AOU24RLB**

**AOU30RLXB**

**AOU36RLXB**



# CONTENTS

---

## 2. OUTDOOR UNIT

---

1. SPECIFICATION .....	02 - 01
2. DIMENSIONS .....	02 - 02
3. REFRIGERANT CIRCUIT .....	02 - 04
4. WIRING DIAGRAMS .....	02 - 06
5. CAPACITY COMPENSATION RATE FOR PIPE LENGTH AND HEIGHT DIFFERENCE .....	02 - 09
6. ADDITIONAL CHARGE CALCULATION .....	02 - 11
7. AIR FLOW .....	02 - 12
8. OPERATION NOISE .....	02 - 14
8-1. NOISE LEVEL CURVE .....	02 - 14
8-2. SOUND LEVEL CHECK POINT .....	02 - 16
9. ELECTRIC CHARACTERISTICS .....	02 - 17
10. SAFETY DEVICES .....	02 - 18

# 1. SPECIFICATION

OUTDOOR UNIT  
AOU18-36RL

OUTDOOR UNIT  
AOU18-36RL

Type		INVERTER HEAT PUMP						
Model name		AOU18RLB	AOU24RLB	AOU30RLXB	AOU36RLXB			
Power source		208 / 230V ~ 60Hz						
Available voltage range		187 - 253V						
Starting current		A	6.4	10.5	13.8	17.0		
Fan	Airflow rate	Cooling	CFM (m <sup>3</sup> /h)	1,206 (2,050)	1,457 (2,475)	2,119 (3,600)		
		Heating		1,083 (1,840)	1,407 (2,355)	2,119 (3,600)		
	Type × Q'ty		Propeller fan × 1					
	Motor output		W	49		100		
Sound pressure level		Cooling	dB (A)	51	54	52		
		Heating		50	55			
Heat exchanger type		Dimensions (H × W × D)	in.	23-2/16 × 34-11/16 × 1-7/16		31-7/16 × 35-7/16 × 1-7/16		
			mm	588 × 881 × 36.4		798 × 900 × 36.4		
		Fin pitch	FPI	20				
		Rows × Stages		2 × 28		2 × 38		
		Pipe type		Copper				
Fin Type		Aluminum						
Compressor		Type × Q'ty		Rotary × 1				
		Motor output		W	1,000	2,100		
Refrigerant		Type		R410A				
		Charge	lbs.oz.	3lbs.1oz.		4lbs.10.1oz.		
	kg		1.40		2.10			
Refrigerant oil		Type		FREOL α68SZ	POE (RB68)			
Enclosure		Material		Steel				
		Color		Beige Approximate color of MUNSELL 10YR7.5/1.0				
Dimensions (H × W × D)		Net	in.	24 - 7/16 × 31 - 2/16 × 11 - 7/16		32-11/16 × 35-7/16 × 13		
			mm	620 × 790 × 290		830 × 900 × 330		
		Gross	in.	28 - 1/16 × 37-3/16 × 15 - 9/16		38-3/16 × 41-5/16 × 17-8/16		
			mm	713 × 945 × 395		970 × 1050 × 445		
Weight			lbs.(kg)	86 (39)		134 (61)		
				93 (42)		150 (68)		
Connenction pipe		Size	Liquid	in. (mm)	Ø 1/4 (Ø 6.35)		Ø 3/8 (Ø 9.52)	
					Gas	Ø 1/2 (Ø 12.70)		Ø 5/8 (Ø 15.88)
		Method		Flare				
		Pre - charge length		ft. (m)	49 (15)		65 (20)	
		Max. length			65 (20)		164 (50)	
Max. height difference		49 (15)			98 (30)			
Operation range		Cooling	°F (°C)				14 to 115 (-10 to 46)	
		Heating					5 to 75 (-15 to 24)	

Note :

Specifications are based on the following conditions.

Cooling : Indoor temperature of 80°F (26.67°C) DB / 67°F (19.44°C) WB, and outdoor temperature of 95°F (35°C) DB / 75°F (23.9°C) WB.

Heating : Indoor temperature of 70°F (21.11°C) DB / 59°F (15°C) WB, and outdoor temperature of 47°F (8.33°C) DB / 43°F (6.11°C) WB.

Pipe length : 24ft.7in (7.5m), Height difference:0 m. (Outdoor unit - Indoor unit)

The protective function might work when using it outside the operation range.

## 2. DIMENSIONS

### ■ MODEL: AOU18RLB, AOU24RLB

Unit : in. (mm)

OUTDOOR UNIT  
AOU18-36RL

OUTDOOR UNIT  
AOU18-36RL

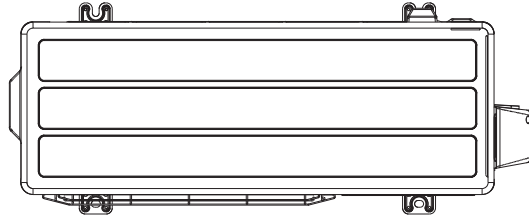

Top view

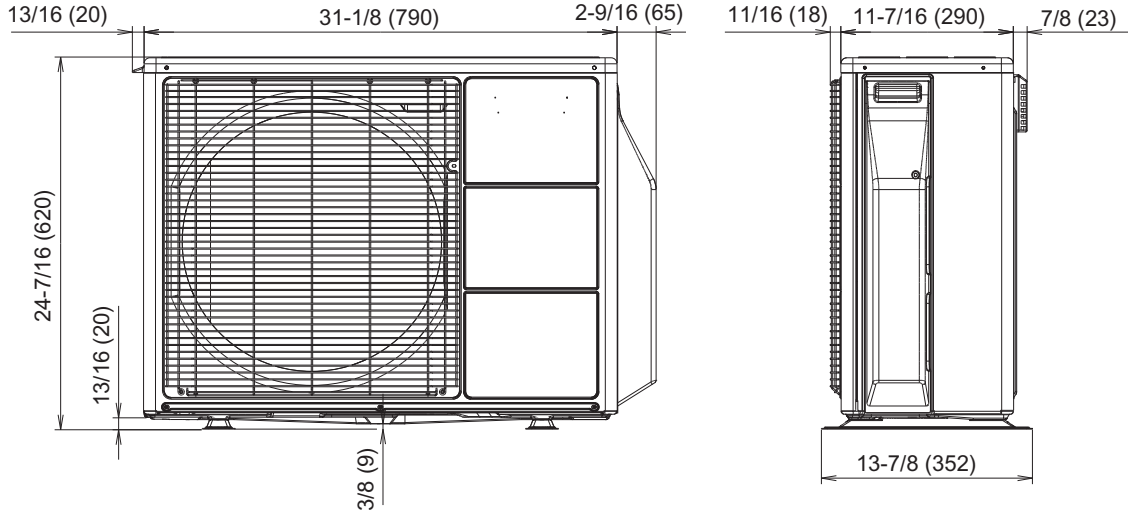

Front view

Side view

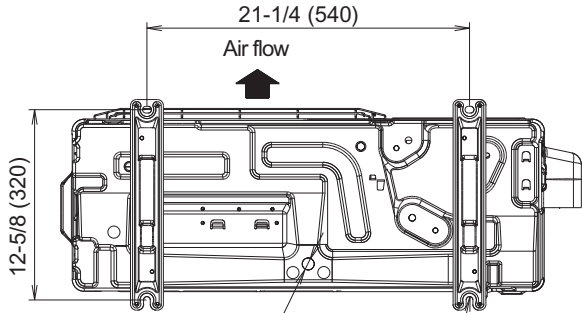

Bottom view

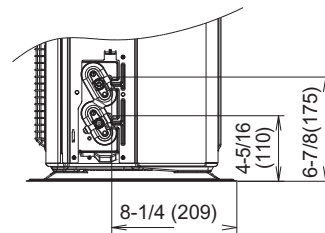

### ■ INSTALLATION PLACE

When there are obstacles at the back or front sides.

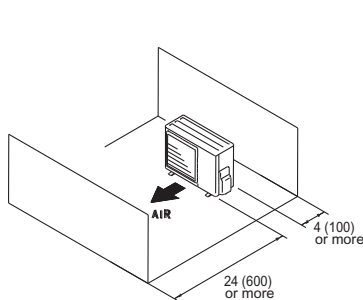

When there are obstacles at the back, side(s), and top.

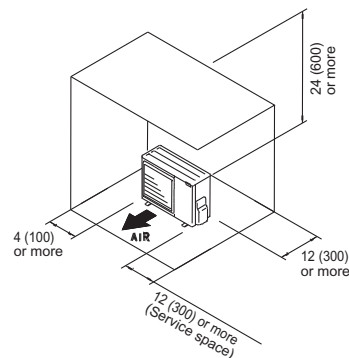

When there are obstacles at the back, side with the installation of more than one unit.

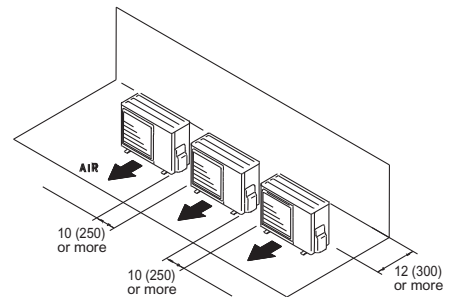

# MODEL: AOU30RLXB, AOU36RLXB

Unit : in. (mm)

OUTDOOR UNIT  
AOU18-36RL

OUTDOOR UNIT  
AOU18-36RL

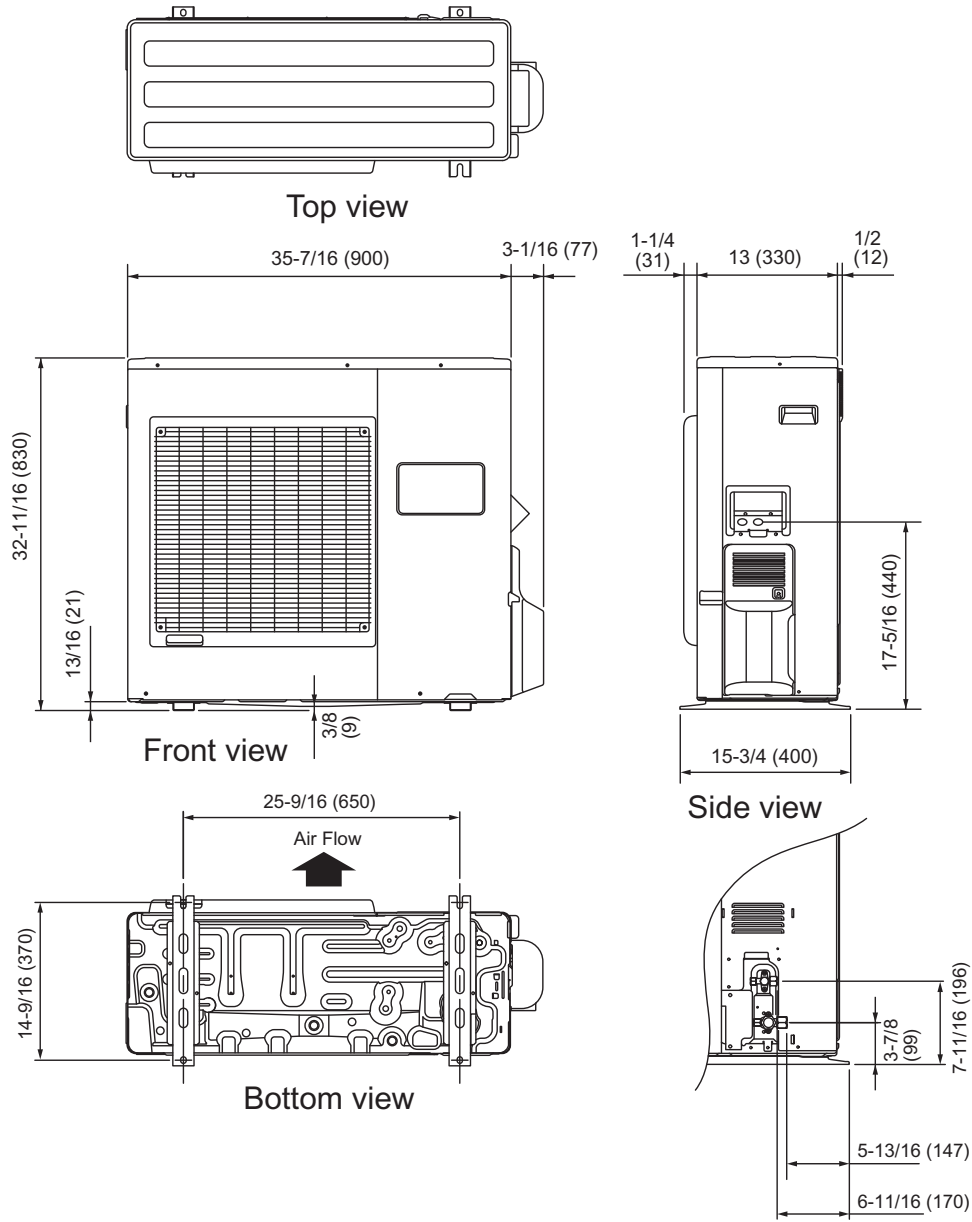

## INSTALLATION PLACE

When there are obstacles at the back or front sides.

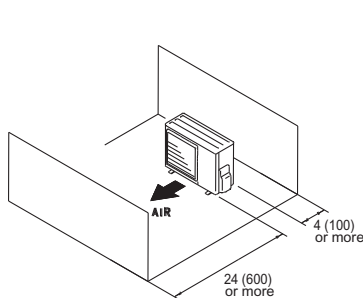

When there are obstacles at the back, side(s), and top.

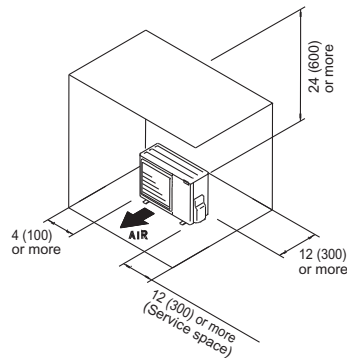

When there are obstacles at the back, side with the installation of more than one unit.

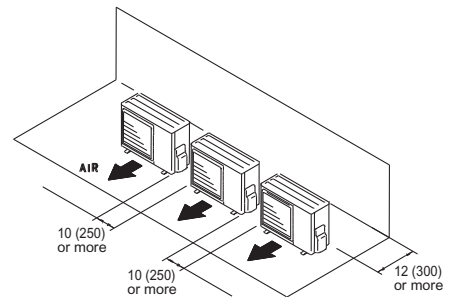

### 3. REFRIGERANT CIRCUIT

■ MODEL: AOU18RLB, AOU24RLB

OUTDOOR UNIT  
AOU18-36RL

OUTDOOR UNIT  
AOU18-36RL

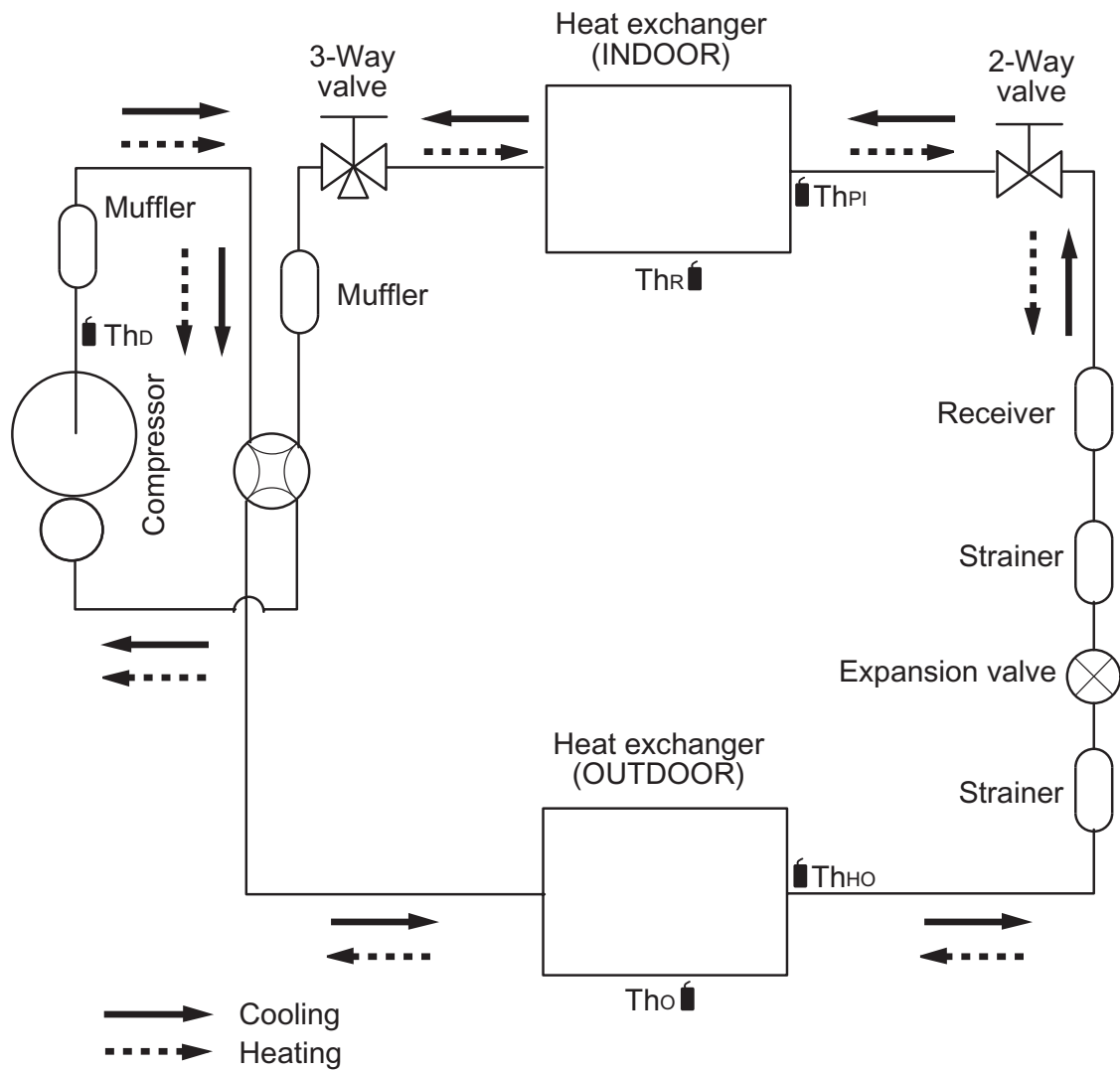

- Th<sub>D</sub> Thermistor (Discharge Temp.)
- Th<sub>O</sub> Thermistor (Outdoor Temp.)
- Th<sub>HO</sub> Thermistor (Heat Exchanger Out Temp.)
- Th<sub>R</sub> Thermistor (Room Temp.)
- Th<sub>PI</sub> Thermistor (Pipe Temp.)

Refrigerant pipe diameter  
 Liquid: 1/4" (6.35 mm)  
 Gas: 1/2" (12.70 mm)

■ MODEL: AOU30RLXB, AOU36RLXB

OUTDOOR UNIT  
AOU18-36RL

OUTDOOR UNIT  
AOU18-36RL

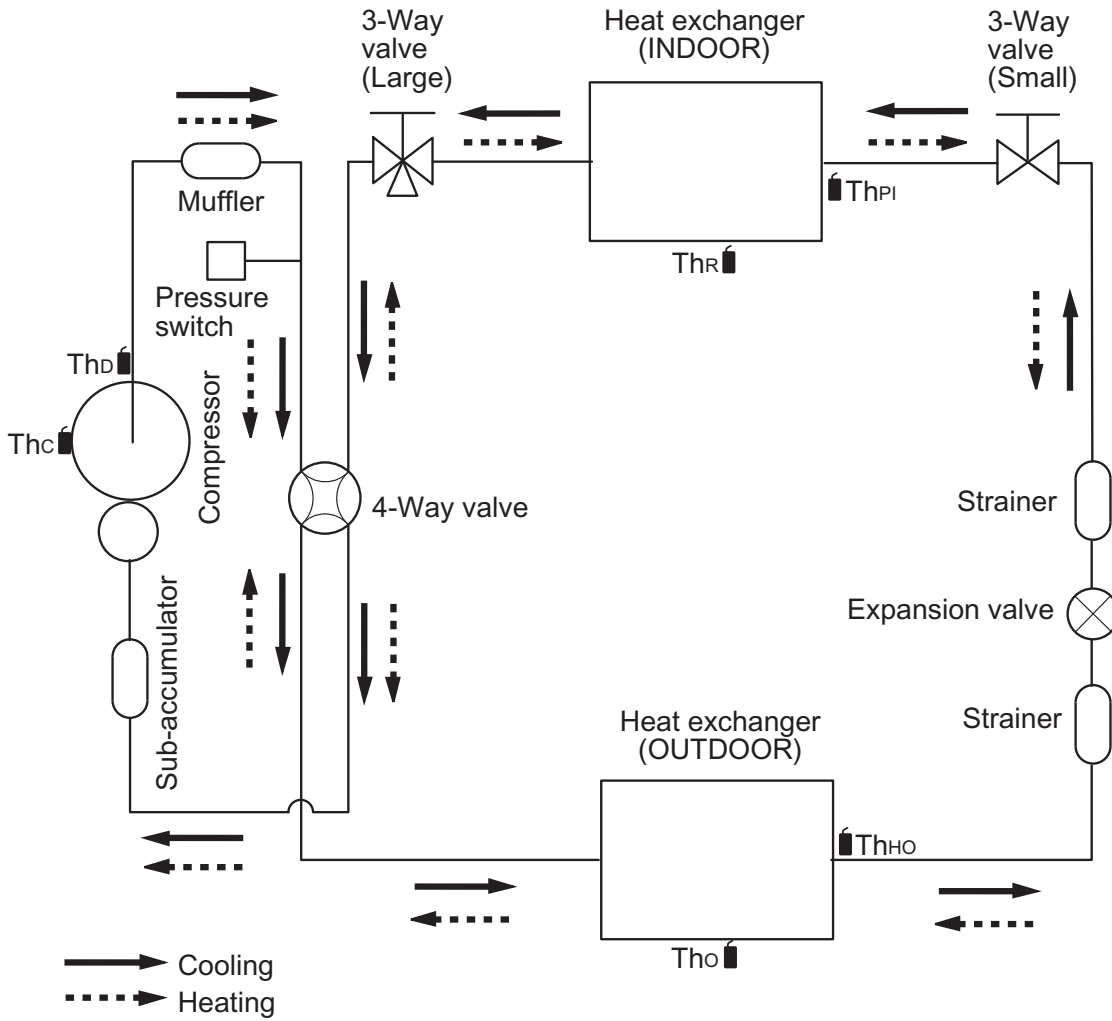

- Thc Thermistor (Compressor Temp.)
- Thd Thermistor (Discharge Temp.)
- Tho Thermistor (Outdoor Temp.)
- ThHo Thermistor (Heat Exchanger Out Temp.)
- ThR Thermistor (Room Temp.)
- ThPI Thermistor (Pipe Temp.)

Refrigerant pipe diameter  
 Liquid: 3/8" (9.52 mm)  
 Gas: 5/8" (15.88 mm)

# 4. WIRING DIAGRAMS

■ MODEL: AOU18RLB, AOU24RLB

OUTDOOR UNIT  
AOU18-36RL

OUTDOOR UNIT  
AOU18-36RL

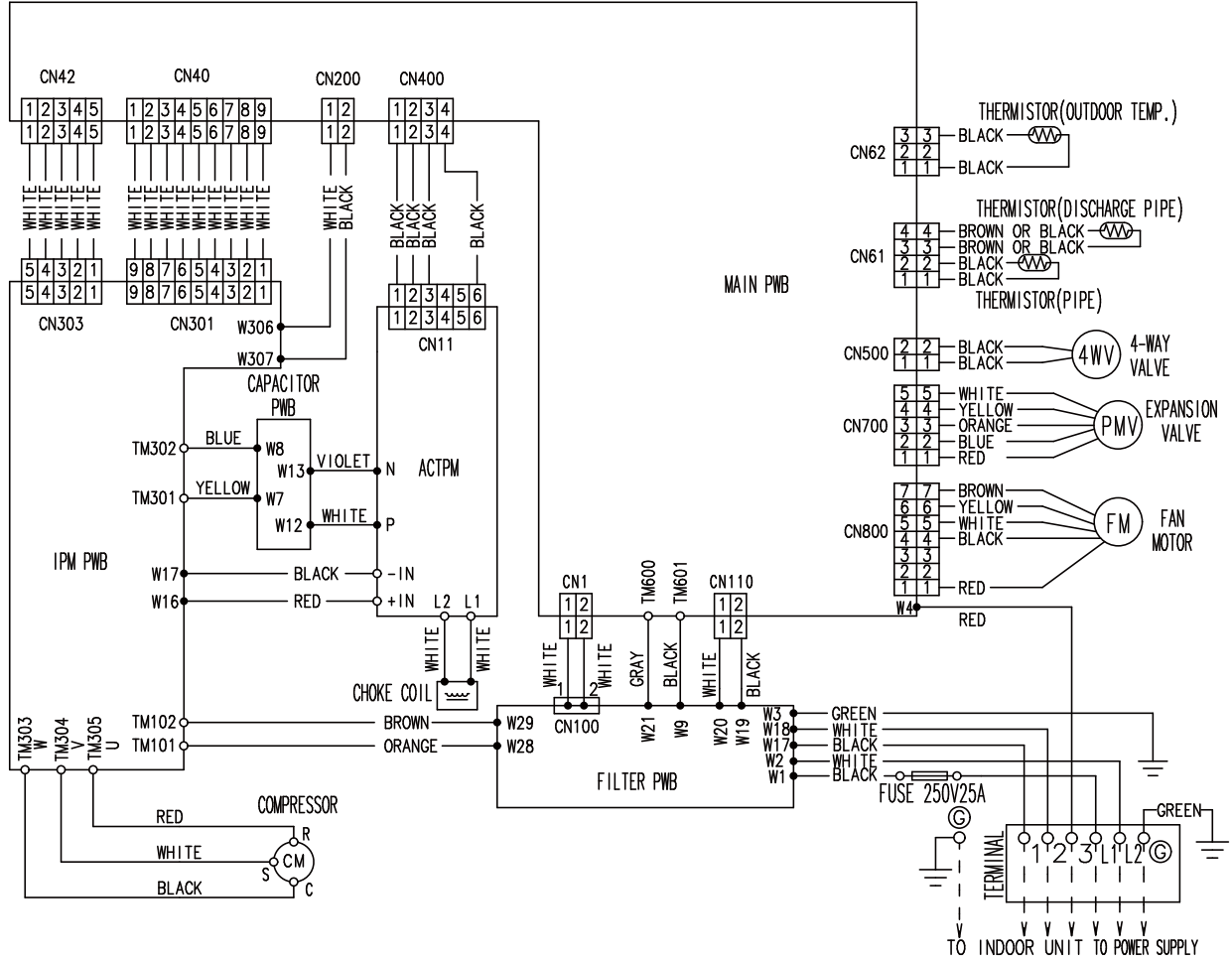

# MODEL: AOU30RLXB, AOU36RLXB

OUTDOOR UNIT  
AOU18-36RL

OUTDOOR UNIT  
AOU18-36RL

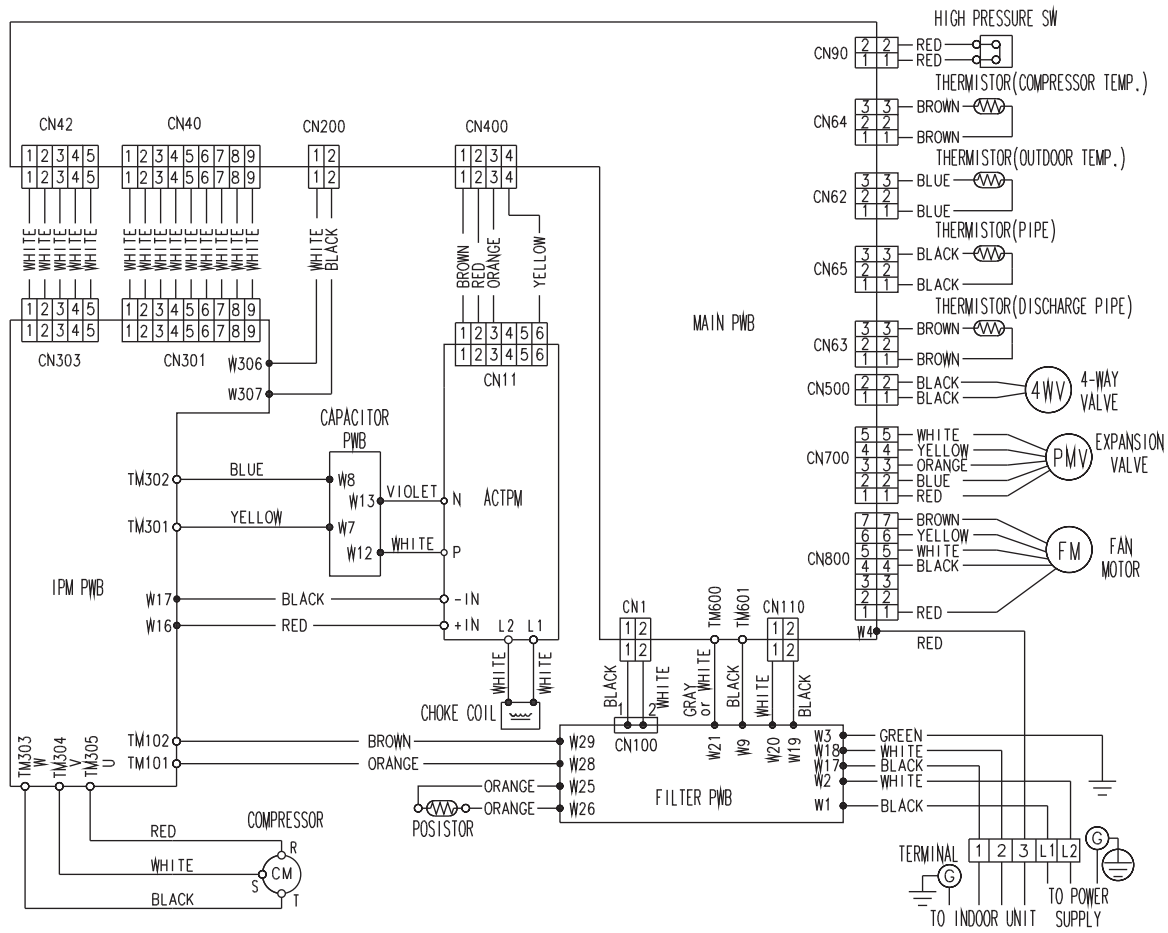



# 5. CAPACITY COMPENSATION RATE FOR PIPE LENGTH AND HEIGHT DIFFERENCE

## MODEL: AOU18RLB, AOU24RLB

OUTDOOR UNIT  
AOU18-36RL

OUTDOOR UNIT  
AOU18-36RL

COOLING				Pipe length (m)				
				5m	7.5m	10m	15m	20m
				17ft.	25ft.	33ft.	50ft.	67ft.
Height difference H	*1 Indoor unit is upper than outdoor unit.	15m	50ft.	-	-	-	0.951	0.950
		10m	33ft.	-	-	0.979	0.967	0.966
		7.5m	25ft.	-	0.988	0.983	0.971	0.970
		5m	17ft.	0.994	0.992	0.987	0.975	0.974
		0m	0ft.	1.002	1.000	0.995	0.983	0.982
	*2 Indoor unit is under than outdoor unit	-5m	-17ft.	1.002	1.000	0.995	0.983	0.982
		-7.5m	-25ft.	-	1.000	0.995	0.983	0.982
		-10m	-33ft.	-	-	0.995	0.983	0.982
		-15m	-50ft.	-	-	-	0.983	0.982

HEATING				Pipe length (m)				
				5m	7.5m	10m	15m	20m
				17ft.	25ft.	33ft.	50ft.	67ft.
Height difference H	*1 Indoor unit is upper than outdoor unit.	15m	50ft.	-	-	-	0.994	0.979
		10m	33ft.	-	-	1.012	0.994	0.979
		7.5m	25ft.	-	1.000	1.012	0.994	0.979
		5m	17ft.	0.969	1.000	1.012	0.994	0.979
		0m	0ft.	0.969	1.000	1.012	0.994	0.979
	*2 Indoor unit is under than outdoor unit	-5m	-17ft.	0.964	0.995	1.007	0.989	0.974
		-7.5m	-25ft.	-	0.993	1.004	0.986	0.972
		-10m	-33ft.	-	-	1.002	0.984	0.969
		-15m	-50ft.	-	-	-	0.974	0.959

Height difference H

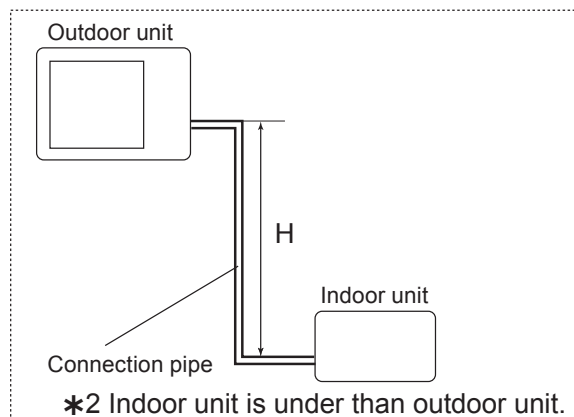
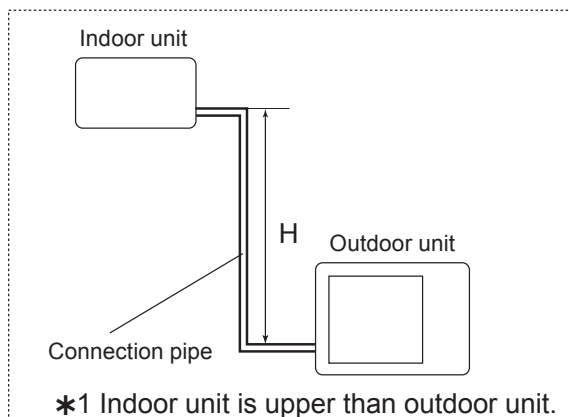

## MODEL: AOU30RLXB, AOU36RLXB

COOLING				Pipe length						
				5m	7.5m	10m	20m	30m	40m	50m
				16ft.	25ft.	33ft.	66ft.	99ft.	131ft.	164ft.
Height difference H	*1 Indoor unit is upper than outdoor unit.	30m	99ft.	-	-	-	-	0.932	0.929	0.924
		20m	66ft.	-	-	-	0.945	0.947	0.945	0.940
		10m	33ft.	-	-	0.984	0.961	0.963	0.960	0.956
		7.5m	25ft.	-	0.988	0.988	0.965	0.967	0.964	0.959
		5m	16ft.	0.990	0.992	0.992	0.968	0.971	0.968	0.963
		0m	0ft.	0.998	1.000	1.000	0.976	0.979	0.976	0.971
	*2 Indoor unit is under than outdoor unit	-5m	-16ft.	0.998	1.000	1.000	0.976	0.979	0.976	0.971
		-7.5m	-25ft.	-	1.000	1.000	0.976	0.979	0.976	0.971
		-10m	-33ft.	-	-	1.000	0.976	0.979	0.976	0.971
		-20m	-66ft.	-	-	-	0.976	0.979	0.976	0.971
		-30m	-99ft.	-	-	-	-	0.979	0.976	0.971

HEATING				Pipe length						
				5m	7.5m	10m	20m	30m	40m	50m
				16ft.	25ft.	33ft.	66ft.	99ft.	131ft.	164ft.
Height difference H	*1 Indoor unit is upper than outdoor unit.	30m	99ft.	-	-	-	-	0.816	0.756	0.686
		20m	66ft.	-	-	-	0.872	0.816	0.756	0.686
		10m	33ft.	-	-	0.991	0.872	0.816	0.756	0.686
		7.5m	25ft.	-	1.000	0.991	0.872	0.816	0.756	0.686
		5m	16ft.	0.986	1.000	0.991	0.872	0.816	0.756	0.686
		0m	0ft.	0.986	1.000	0.991	0.872	0.816	0.756	0.686
	*2 Indoor unit is under than outdoor unit	-5m	-16ft.	0.981	0.995	0.986	0.868	0.812	0.752	0.683
		-7.5m	-25ft.	-	0.993	0.983	0.866	0.810	0.750	0.681
		-10m	-33ft.	-	-	0.981	0.864	0.808	0.748	0.679
		-20m	-66ft.	-	-	-	0.855	0.799	0.740	0.672
		-30m	-99ft.	-	-	-	-	0.791	0.733	0.665

Height difference H

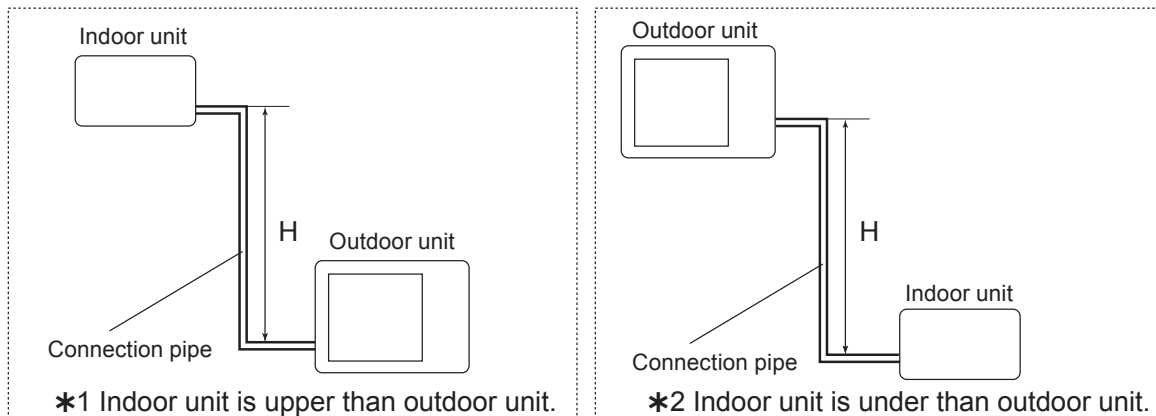

## 6. ADDITIONAL CHARGE CALCULATION

### ■ MODEL: AOU18RLB, AOU24RLB

Refrigerant type		R410A
Refrigerant amount	lbs. oz.	3lbs. 1oz.
	g	1400

#### ● REFRIGERANT CHARGE

Total pipe length	ft.	49 or less	66 (MAX)	0.22oz./ft. (20g/m)
	m	15 or less	20 (MAX)	
Additional charge	oz.	0	3.5	
	g	0	100	

### ■ MODEL: AOU30RLXB, AOU36RLXB

Refrigerant type		R410A
Refrigerant amount	lbs. oz.	4lbs. 10.1oz.
	g	2100

#### ● REFRIGERANT CHARGE

Total pipe length	ft.	66 or less	98	131	164	0.43oz./ft. (40g/m)
	m	20 or less	30	40	50 (MAX)	
Additional charge	oz.	0	14.1	28.2	42.3	
	g	0	400	800	1200	

## 7. AIR FLOW

### ■ MODEL: AOU18RLB

#### ● Cooling

Air flow	
2050	m <sup>3</sup> /h
569	l/s
1206	CFM

#### ● Heating

Air flow	
1840	m <sup>3</sup> /h
511	l/s
1083	CFM

### ■ MODEL: AOU24RLB

#### ● Cooling

Air flow	
2475	m <sup>3</sup> /h
688	l/s
1457	CFM

#### ● Heating

Air flow	
2355	m <sup>3</sup> /h
654	l/s
1407	CFM

■ **MODEL: AOU30RLXB**

● **Cooling**

Air flow	
3600	m <sup>3</sup> /h
1000	l/s
2119	CFM

● **Heating**

Air flow	
3600	m <sup>3</sup> /h
1000	l/s
2119	CFM

■ **MODEL: AOU36RLXB**

● **Cooling**

Air flow	
3600	m <sup>3</sup> /h
1000	l/s
2119	CFM

● **Heating**

Air flow	
3600	m <sup>3</sup> /h
1000	l/s
2119	CFM

# 8. OPERATION NOISE

## 8-1. NOISE LEVEL CURVE

OUTDOOR UNIT  
AOU18-36RL

### MODEL: AOU18RLB

#### ● Cooling

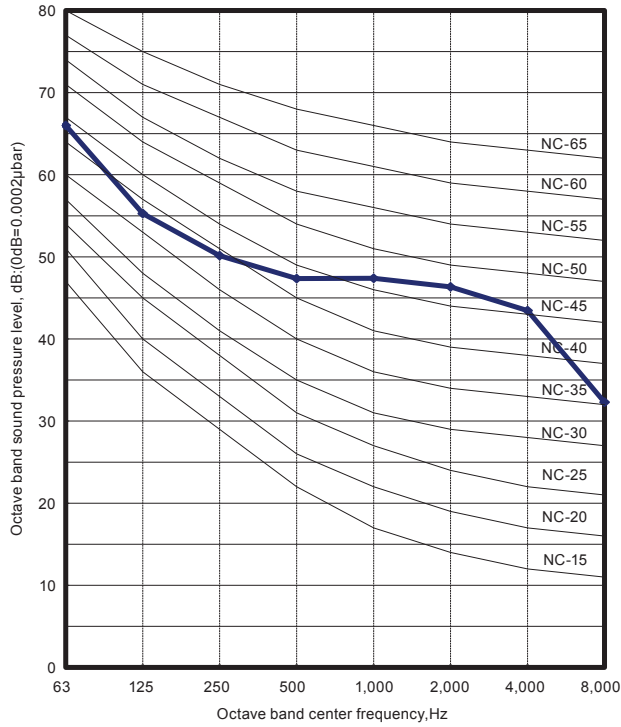

#### ● Heating

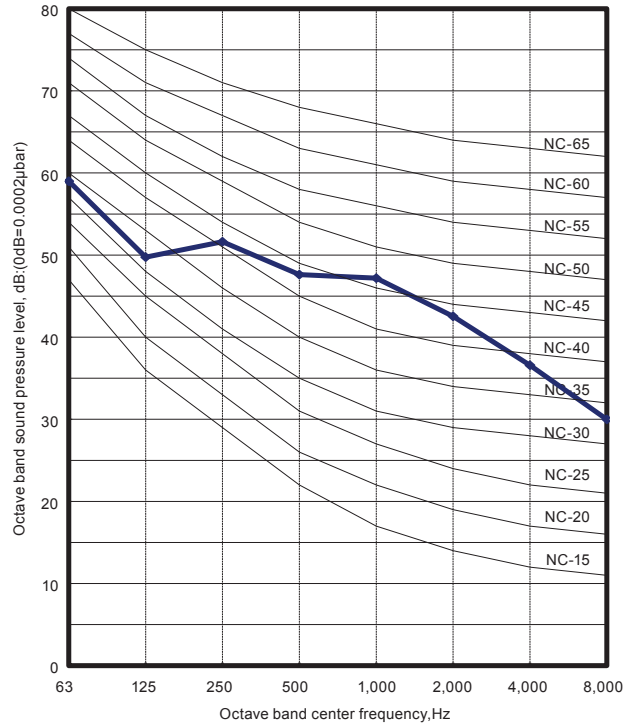

OUTDOOR UNIT  
AOU18-36RL

### MODEL: AOU24RLB

#### ● Cooling

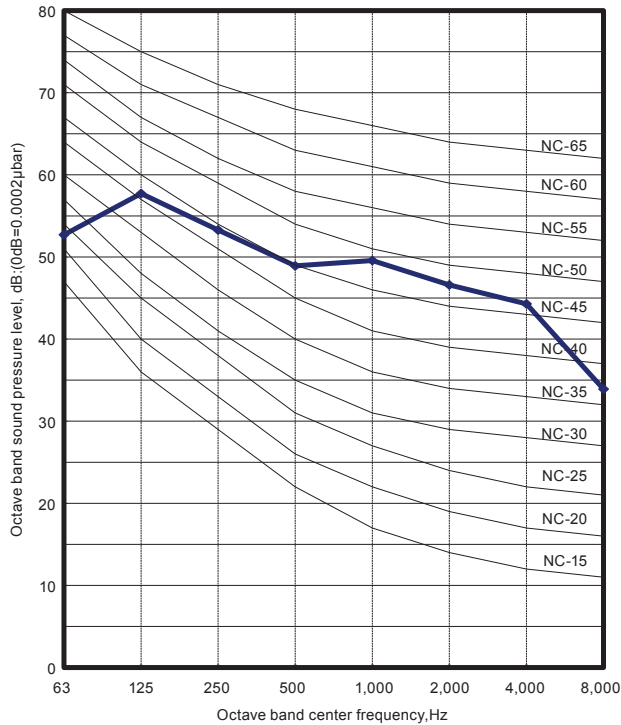

#### ● Heating

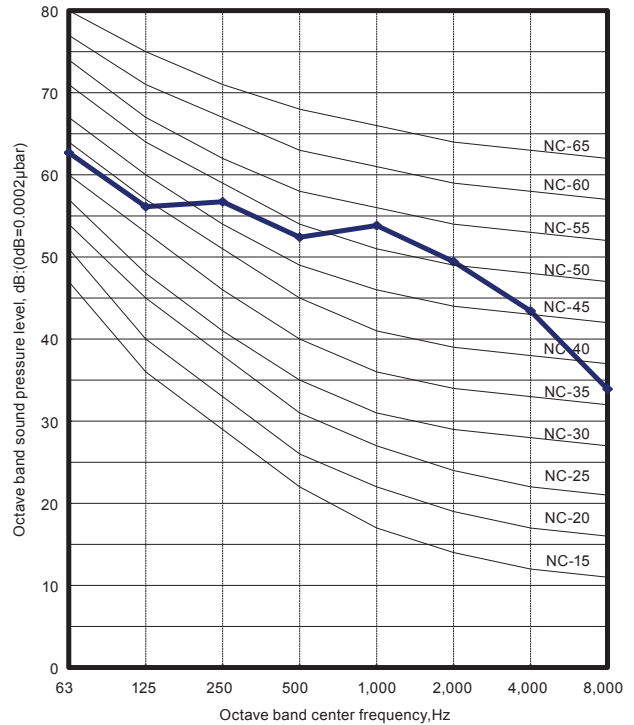

**MODEL: AOU30RLXB**

**● Cooling**

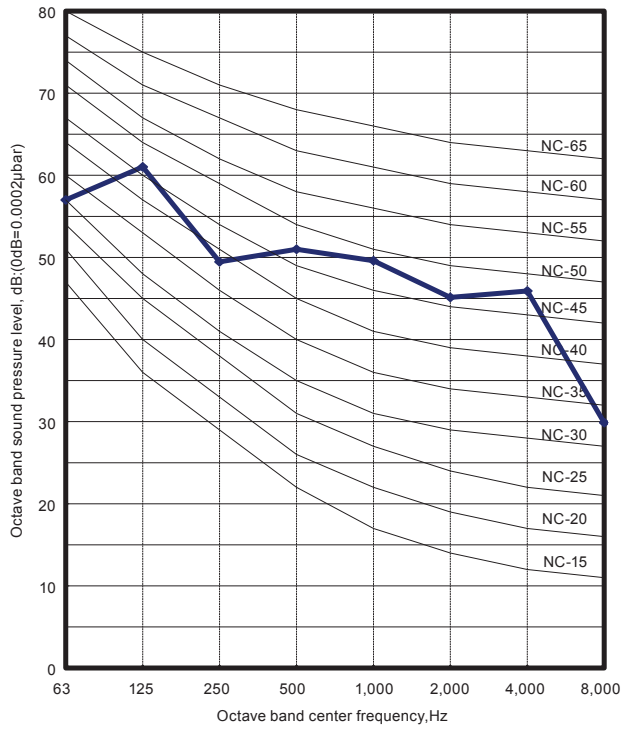

**● Heating**

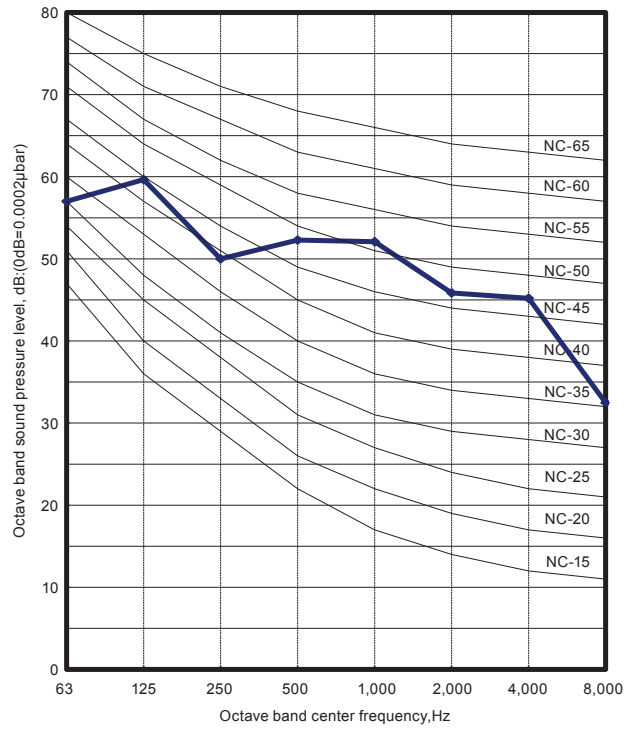

**MODEL: AOU36RLXB**

**● Cooling**

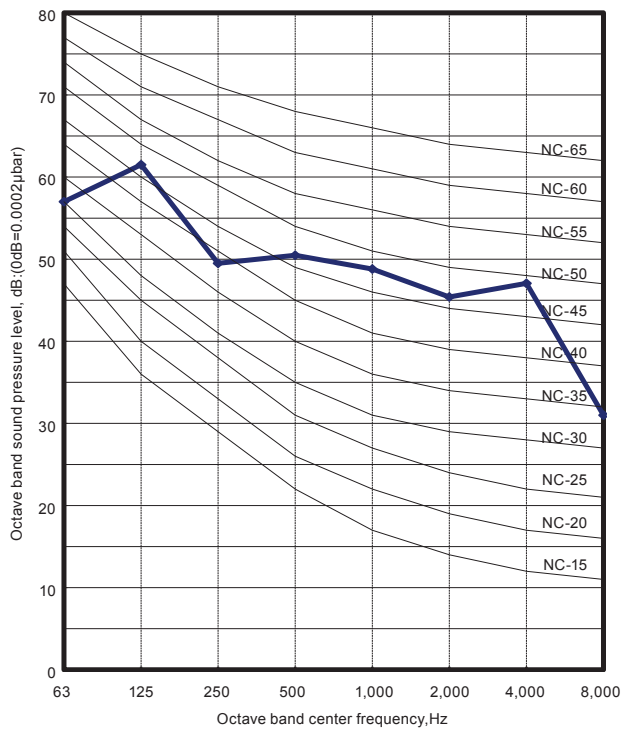

**● Heating**

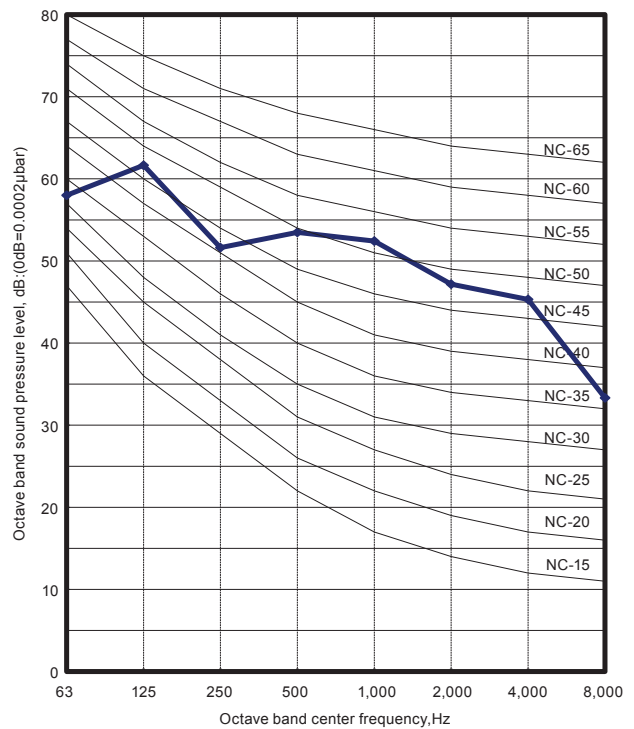

# 8-2. SOUND LEVEL CHECK POINT

OUTDOOR UNIT  
AOU18-36RL

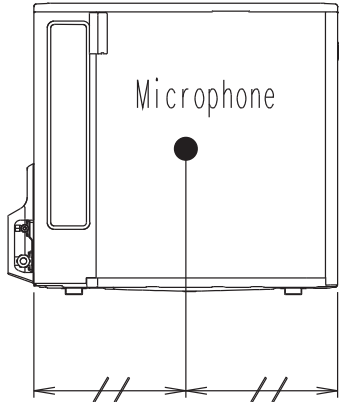
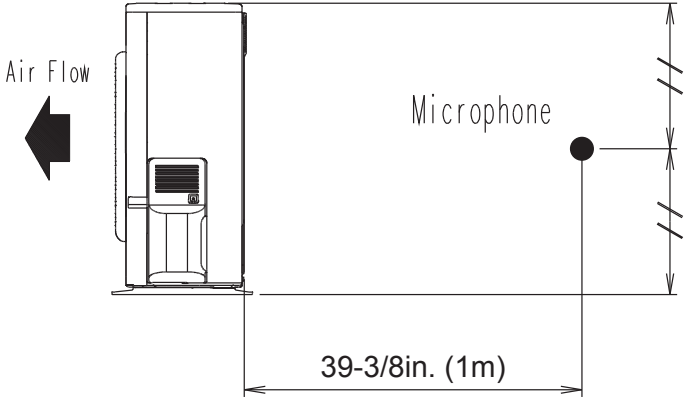

OUTDOOR UNIT  
AOU18-36RL



## 9. ELECTRIC CHARACTERISTICS

OUTDOOR UNIT  
AOU18-36RL

OUTDOOR UNIT  
AOU18-36RL

Model name			AOU18RLB	AOU24RLB	AOU30RLXB	AOU36RLXB
Power supply	Voltage	V	208 / 230 ~			
	Frequency	Hz	60			
MCA		A	14.6	17.1	23.3	
Starting current		A	6.4	10.5	13.8	17.0
Wiring spec. *1	MAX. CKT. BKR	A	15	20	30	
	Power cable	AWG	14	12	10	
	Connection cable *2	AWG	14			
	Limited wiring length : ft. (m)		68 (21)		167 (51)	

\*1 : Selected sample based on Japan Electrotechnical Standards and Codes Committee E0005.

\*2 : Limit voltage drop to less than 2%. Increase conductor size if voltage drop is 2% or more.

MCA : Min Circuit Amp (Calculation based on UL1995)

MAX. CKT. BKR : Maximum Circuit Breaker

# 10. SAFETY DEVICES

OUTDOOR UNIT  
AOU18-36RL

OUTDOOR UNIT  
AOU18-36RL

	Protection form	Model			
		AOU18RLB	AOU24RLB	AOU30RLXB	AOU36RLXB
Circuit protection	Current fuse (NEAR THE TERMINAL)	5A 250V			
	Current fuse (MAIN PRINTED CIRCUIT BOARD)	3.15A 250V x 2			
Fan motor protection	Thermal protection program	OFF : 212±27°F (100±15°C) ON : 203±18°F (95±10°C)		OFF : 302±27°F (150±15°C) ON : 248±27°F (120±15°C)	
High Pressure Protection	Pressure Switch	OFF : 4.2±0.1MPa ON : 3.2±0.15MPa			
Compressor protection	Thermal protection program (COMPRESSOR TEMP.)	-		OFF : 226°F (108°C) ON : 176°F (80°C)	
	Thermal protection program (DISCHARGE TEMP.)	OFF : 230 °F (110 °C) ON : After 7 minutes			
	Thermal protection program (OUTDOOR TEMP.) (Cooling/Dry mode)	OFF : 5°F (-15°C) ON : 14°F (-10°C)		OFF : -13°F (-25°C) ON : -4°F (-20°C)	